

SIEMENS

SIPROTEC

System Description

Preface, Contents

System Overview

1

The SIPROTEC Devices

2

Getting Started

3

Managing Projects and Devices

4

Configuration

5

Control during Operation

6

Communication

7

Maintenance and Immediate Help,
Test Functions

8

Appendix

A

Appendix

B

Literature, Glossary, Index



NOTE

For your own safety, please observe the Notes and Warnings in the Preface.

Disclaimer of Liability

This document has been subjected to rigorous technical review before being published. It is revised at regular intervals, and any modifications and amendments are included in the subsequent issues. The content of this document has been compiled for information purposes only. Although Siemens AG has made best efforts to keep the document as precise and up-to-date as possible, Siemens AG shall not assume any liability for defects and damage which result through use of the information contained herein.

This content does not form part of a contract or of business relations; nor does it change these. All obligations of Siemens AG are stated in the relevant contractual agreements.

Siemens AG reserves the right to revise this document from time to time.

Document Release: E50417-H1176-C151-B4.00
Edition: 12.2011
Product version: V4.85

Copyright

Copyright © Siemens AG 2011. All rights reserved.

The disclosure, duplication, distribution and editing of this document, or utilization and communication of the content are not permitted, unless authorized in writing. All rights, including rights created by patent grant or registration of a utility model or a design, are reserved.

Registered Trademarks

SIPROTEC, DIGSI, SIGUARD, SIMEAS and SICAM are registered trademarks of Siemens AG. Any unauthorized use is illegal. All other designations in this document can be trademarks whose use by third parties for their own purposes can infringe the rights of the owner.

Preface

Purpose of this Manual

This manual generally describes the management, configuration, parameterization, operation, mounting and commissioning of a SIPROTEC device.

Please refer to the device manuals for further details on the functionality of your device, on the individual parameters and on the display structure of the plant data.

Target Audience

System designers, protection engineers, commissioning engineers, personnel concerned with adjustment, checking, and service of selective protective equipment, automatic and control facilities, and personnel of electrical facilities and power plants.

Prerequisites

Basic knowledge of Windows is assumed.

Applicability of this Manual

This manual applies to DIGSI 4 devices as from system firmware Version 4.85 and DIGSI from V4.3. It also describes the integration of SIPROTEC V2 / V3 devices into organization and management.



Details regarding conformity

This product complies with the directive of the Council of the European Communities on the approximation of the laws of the Member States relating to electromagnetic compatibility (EMC Council Directive 89/336/EEC) and concerning electrical equipment for use within specified voltage limits (Low-voltage directive 73/23 EEC).

This conformity is the result of a test conducted by Siemens AG in accordance with Article 10 of the directive in agreement with the generic standards EN 50081 and EN 50082 for the EMC directive, and with the standard EN 60255-6 for the low-voltage directive.

The device is designed in accordance with the international standards of IEC 255 and the German standards DIN 57 435 part 303 (corresponding to VDE 0435 part 303).

Hotline

Our Customer Support Center provides around-the-clock support.

Phone: +49 (180) 524-7000
Fax: +49 (180) 524-2471
e-mail: support.ic@siemens.com

Training courses

If you are interested in our current training program, please contact our training center:

Siemens AG
Siemens Power Academy

Humboldtstr. 59
90459 Nuremberg
Germany

Phone: +49 (911) 433-7415
Fax: +49 (911) 433-5482
e-mail: td.power-academy.energy@siemens.com
Internet: www.siemens.com/energy/power-academy

Notes On Safety

This manual does not constitute a complete catalog of all safety measures required for operating the equipment (module, device) in question, because special operating conditions may require additional measures. However, it does contain notes that must be adhered to for your own personal safety and to avoid damage to property. These notes are highlighted with a warning triangle and different keywords indicating different degrees of danger.



DANGER

Danger means that death or severe injury **will** occur if the appropriate safety measures are not taken.

- Follow all advice instructions to prevent death or severe injury.
-



WARNING

Warning means that death or severe injury **can** occur if the appropriate safety measures are not taken.

- Follow all advice instructions to prevent death or severe injury.
-



CAUTION

Caution means that minor or moderate injury can occur if the appropriate safety measures are not taken.

- Follow all advice instructions to prevent minor injury.
-

NOTICE

Notice means that damage to property can occur if the appropriate safety measures are not taken.

- Follow all advice instructions to prevent damage to property.
-



NOTE

is important information about the product, the handling of the product, or the part of the documentation in question to which special attention must be paid.

Qualified Personnel

Commissioning and operation of the equipment (module, device) described in this manual must be performed by qualified personnel only. As used in the safety notes contained in this manual, qualified personnel are those persons who are authorized to commission, release, ground and tag devices, systems, and electrical circuits in accordance with safety standards.

Use as Prescribed

The equipment (device, module) must not be used for any other purposes than those described in the Catalog and the Technical Description. If it is used together with third-party devices and components, these must be recommended or approved by Siemens.

Correct and safe operation of the product requires adequate transportation, storage, installation, and mounting as well as appropriate use and maintenance.

During the operation of electrical equipment, it is unavoidable that certain parts of this equipment will carry dangerous voltages. Severe injury or damage to property can occur if the appropriate measures are not taken:

- Before making any connections at all, ground the equipment at the PE terminal.
- Hazardous voltages can be present on all switching components connected to the power supply.
- Even after the supply voltage has been disconnected, hazardous voltages can still be present in the equipment (capacitor storage).
- Equipment with current transformer circuits must not be operated while open.
- The limit values indicated in the manual or the operating instructions must not be exceeded; this also refers to testing and commissioning.

The following symbols are used in drawings:

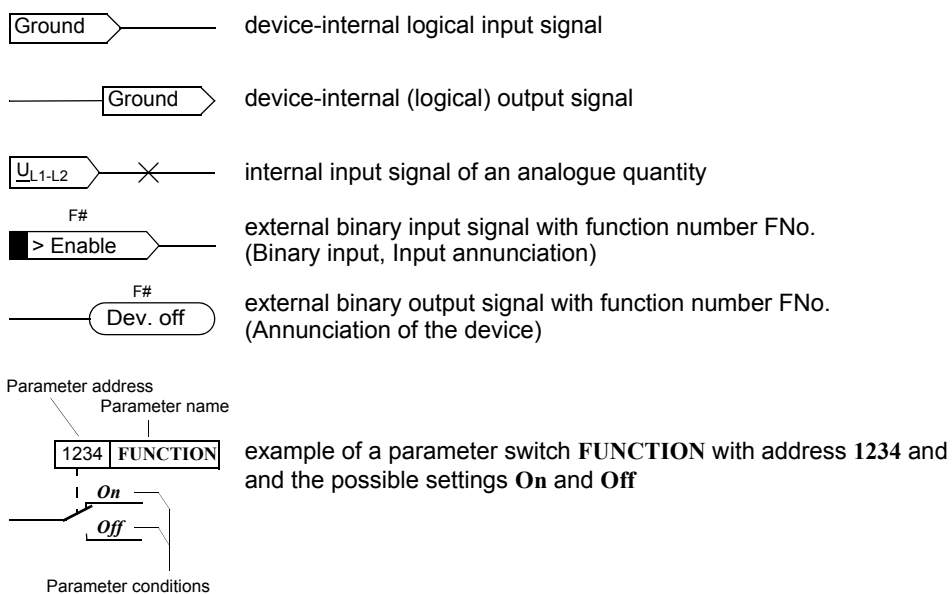

In general the switch characters in accordance with IEC 60617-12 and IEC 60617-13 are used extensively, or can be derived from them.

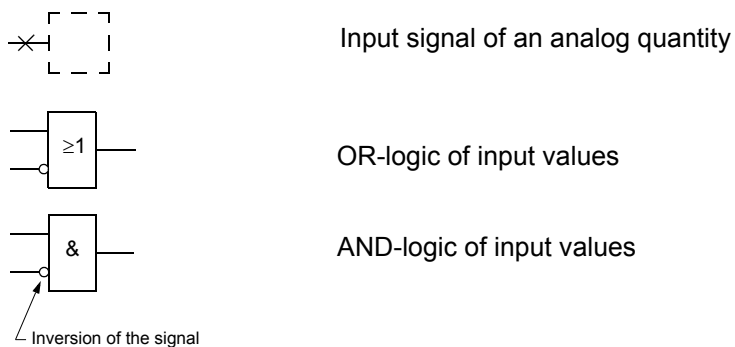

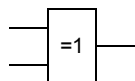

Exclusive OR (non-equivalence): Output active if only *one* of the inputs is active

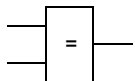

Coincidence: Output active if *both* inputs are active in cumulation

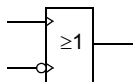

Dynamic input signals

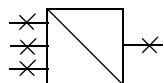

Formation of an analog output signal from several analog input signals

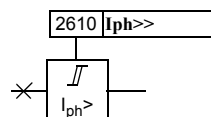

Limit stage with parameter address and parameter name

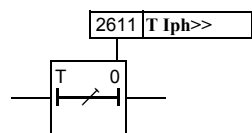

Timing element (pick-up delay) with parameter address and parameter name

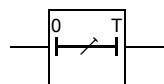

Timing element (resetting time delay)

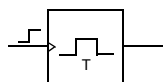

Edge-triggered timing element with the action time T

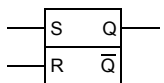

Static memory (RS-flipflop) with Set Input (S), Reset Input (R), Output (Q) and negated output (\bar{Q})

Contents

1	System Overview	17
1.1	General	18
1.2	Communication	19
1.2.1	Time Synchronization	21
1.2.2	Serial Interfaces	21
1.3	Operator Interface	23
1.3.1	Operator Control Panels	23
1.3.2	DIGSI 4	24
1.4	Setting Parameters	25
1.4.1	Functional Scope	26
1.4.2	Configuration	26
1.4.3	Programmable Logic CFC	26
1.4.4	Power System Data	27
1.4.5	Settings Groups	27
1.4.6	Passwords	28
1.5	Control Operations	29
1.5.1	Indications	30
1.5.2	Measured Values	30
1.5.3	Fault Records	31
1.5.4	Controlling / Manual Updating Equipment	32
1.5.5	Setting Taggings	32
2	The SIPROTEC Devices	33
2.1	Operator Control Panels of the Devices	34
2.1.1	Operator Control Panel with 4-line Display	34
2.1.2	Operator Control Panel with Graphical Display	35
2.1.3	Keys of the Operator Control Panels	36
2.2	Device Types for Panel Flush Mounting and Cubicle Mounting	38
2.2.1	Housing	38
2.2.2	Front and Rear View of the Device Variants	39
2.3	Device Types for Panel Surface Mounting	42
2.3.1	Housing	42
2.3.2	Front View of the Device Variants	43
2.4	Device Types with Detached Operator Control Panel	46
2.4.1	Housing and Operating Unit	46
2.4.2	Views of Operator Control Unit and Devices - Variants	47

2.5	Device Type Surface-mounted Housing without Operator Control Panel	48
2.5.1	Surface-mounted Housing and Dongle Cable	48
2.6	Connections with Screw Terminals - Panel Flush Mounting	50
2.6.1	Connection Modules for Voltage Connections	50
2.6.2	Connection Modules for Current Connections	52
2.6.3	Short Circuit Links and Covering Caps	54
2.7	Connections with Screw Terminals - Panel Surface Mounting	56
2.8	Connections for Plug-in Terminals	57
2.9	Connections for Optical Fibers - Panel Flush Mounting	61
2.10	Connections for Optical Fibers - Panel Surface Mounting	62
2.11	Connections for Electrical Serial Interfaces	65
2.12	Connections for Analog Output	67
2.12.1	Panel Flush Mounting	67
2.12.2	Panel Surface Mounting	68
2.13	Connections for Low-level Signal Converter	69
3	Getting Started	71
3.1	Unpacking and Packing	72
3.2	Device Inspections upon Receipt	73
3.2.1	Check of the Rated Data	73
3.2.2	Electrical Check	74
3.3	Using the Operator Control Panel of the SIPROTEC 4 Device	75
3.3.1	User Interface	75
3.3.2	Navigating in the Operator Tree of the Display	75
3.3.3	Reading out the Type Designation	76
3.3.4	Reading Out Operational Measured Values	77
3.3.5	Reading out Operational Indications	77
3.3.6	Setting the Display Contrast	78
3.4	Installing / Removing / Starting DIGSI 4	79
3.4.1	Installing DIGSI 4	79
3.4.2	Removing DIGSI 4	81
3.4.3	Starting DIGSI 4	81
3.4.4	Working with DIGSI 4	81
3.5	Storage	82
4	Managing Projects and Devices	83
4.1	General	84

4.2	Projects	86
4.2.1	Project Structure	86
4.2.2	Objects Within the Project Structure	87
4.2.3	Creating a Project	88
4.2.4	Editing Objects of a Project	89
4.2.5	Specifying and Changing the Storage Location for Projects	92
4.2.6	Opening and Closing Projects	93
4.2.7	Arranging Project Windows	94
4.2.8	Copying Projects	97
4.2.9	Deleting Projects	98
4.2.10	Reorganizing Projects	99
4.2.11	Managing Projects	100
4.2.12	Archive Settings for Projects	101
4.2.13	Archiving Projects	105
4.2.14	Retrieving Projects	107
4.2.15	Working under the SIMATIC Manager	108
4.3	Devices	110
4.3.1	Inserting a SIPROTEC Device	110
4.3.2	Specifying the Device Model	111
4.3.3	Offline / Online Operating Mode	112
4.3.4	Opening the SIPROTEC 4 Device	113
4.3.5	DIGSI Operating Tree	115
4.3.6	Triggering a Restart and a Resume	116
4.3.7	Setting the Time and Date in the SIPROTEC Device	117
4.3.8	Changing the Operating Mode	118
4.3.9	Cleaning Up the Data	118
4.3.10	Reading Out the Error Log	119
4.3.11	Closing the SIPROTEC Device	120
4.3.12	Copying Devices	121
4.3.13	Editing Data of V3/V2 Devices	121
4.3.14	Inserting Existing V3 Systems	122
4.4	Setting Values	125
4.4.1	Saving Setting Values in the Permanent Memory of the PC	126
4.4.2	Transferring Setting Values to the Device	126
4.4.3	Transferring Setting Values from the Device	127
4.4.4	Comparing Setting Values	128
4.5	Operating Language	131
4.5.1	Setting the DIGSI 4 Operating Language	132
4.5.2	Selecting the PC Device Language	133
4.5.3	SIPROTEC Device Operating Language	134
4.6	Passwords	135
4.7	Exporting / Importing Data	141
4.7.1	Exporting the Data of a SIPROTEC Device	142
4.7.2	Importing Data	144
4.7.3	Exporting the Settings of Protection Functions	148
4.7.4	Exporting Fault Record Data	149
4.7.5	Exporting Configurations and Protection Parameters	150
4.7.6	Exporting System Interface Information	151
4.7.7	Exporting CFC charts	152

4.8	Updating the SIPROTEC 4 Device Types	153
4.8.1	Installing New Device Types	153
4.8.2	Updating Existing Device Types	155
4.8.3	Updating existing SIPROTEC 4 Devices in Projects	156
4.9	Creating and Using User-defined Device Texts	159
4.10	Printing	160
4.10.1	Printing an Object List	160
4.10.2	Printing Selected Information	161
4.10.3	Print Preview	162
4.10.4	How to print selected items of information to file	162
5	Configuration	165
5.1	Parameter Settings Overview	166
5.2	Properties of a SIPROTEC 4 Device	169
5.2.1	MLFB Tab	170
5.2.2	Communications Modules Tab	171
5.2.3	System Management Tab	171
5.2.4	Communications Modules Tab	171
5.3	Specifying the Functional Scope of a SIPROTEC 4 Device	172
5.4	Using Settings Groups	174
5.5	Allocating Information Items	178
5.5.1	Overview	178
5.5.2	Configuring Information to Binary Inputs (Source)	183
5.5.3	Configuring Information to Analog Inputs (Source)	185
5.5.4	Configuring Information to Function Keys (Source)	185
5.5.5	Configuring Information to Binary Outputs (Destination)	186
5.5.6	Configuring Information to LEDs (Destination)	188
5.5.7	Configuring Information to System Interface (Source)	189
5.5.8	Configuring Information to the System Interface (Destination)	190
5.5.9	Configuring Information to the Default Display and Control Display (Destination)	192
5.5.10	Configuring Information to the Buffer (Destination)	194
5.5.11	Configuring Information to Measured Value Windows (Destination)	195
5.5.12	Configuring Information to Metered Value Window (Destination)	195
5.5.13	Configuring Information to Control (Destination)	196
5.5.14	Configuring Information to the CFC (Destination)	198
5.5.15	Configuring Information to CFC (Source)	200
5.6	Displaying Information	202
5.6.1	Filtering	202
5.6.2	Displaying / Hiding Lines or Columns	203
5.7	Inserting and Deleting Information	204
5.7.1	Inserting Information into a Group	208
5.7.2	Inserting an Information Group	209
5.7.3	Renaming Groups and Information	210
5.7.4	Deleting Groups and Information	211

5.8	Properties of Items of Information	212
5.8.1	Default Selection	213
5.8.2	Marking in the Fault Record	214
5.8.3	Chatter Blocking and Filter	214
5.8.4	Transformer Taps	215
5.8.5	Pulse Type and Error Input	217
5.8.6	Restore Trigger and Energy Flow Direction	217
5.8.7	Measured Value Description	218
5.8.8	Bit Pattern	218
5.8.9	Lock	219
5.8.10	Times	221
5.8.11	Transmission Threshold	222
5.8.12	IEC 103 (IEC 60870-5-103)	223
5.8.13	Protocol Info.	224
5.8.14	Measured Value - Destination	225
5.8.15	Fast indications	226
5.9	Configuring the Metered Value Restoring Function	227
5.10	Configuring Chatter Blocking	228
5.11	Setting Measuring Transducers	230
5.12	Configuring Limit Measured Values	231
5.13	Creating User-definable Functions with CFC	232
5.14	Editing Default and Control Displays	233
5.14.1	Creating Default and Control Displays	234
5.14.2	Drawing and Configuring a Default Display	237
5.14.3	Drawing the Topology	242
5.14.4	Positioning Devices	247
5.14.5	Using a User Text	253
5.14.6	Positioning Symbols	256
5.14.7	Positioning Text	259
5.14.8	Checking the Default Display	260
5.14.9	Saving the Default Display	264
5.14.10	Drawing and Configuring a Control Display	264
5.14.11	Making a Positioned Device Operator-controllable	266
5.14.12	Specifying the First Operator-controllable Device	267
5.14.13	Creating Symbols	268
5.14.14	Creating a Device	276
5.15	Setting Interface Settings	282
5.16	Date and Time Setup	283
5.16.1	Date/Time Setup in Devices with Protection Data Interface	286
5.17	Setting Further Parameters	291
5.18	Editing Parameter Settings in Settings Groups	292
5.18.1	Editing Text and Decimal Parameters	294
5.18.2	Editing Table Parameters	295
5.19	Working with User-defined Characteristics	297
5.19.1	Changing the Characteristic Course	299
5.20	Using Zone Diagrams	300
5.21	Setting the Order of Fault Indications	302

6	Control during Operation	303
6.1	Reading All the Process Data from the Device.	304
6.2	Indications.	305
6.2.1	Basic Information on Reading Out Indications	306
6.2.2	Event Log (Operational Indications)	309
6.2.3	Trip Log (Fault Indications)	311
6.2.4	Sensitive Ground Fault Log (Ground-fault Indications).	314
6.2.5	General Interrogation	316
6.2.6	Spontaneous Indications.	317
6.2.7	Saving and Deleting the Indication Memory	318
6.2.8	Reading Out the Counters and Memories of the Switching Statistics.	320
6.2.9	Resetting and Setting the Counters and Memories of the Switching Statistics. .	321
6.2.10	Resetting Indications Output on LEDs	322
6.2.11	Resetting Indications Saved to Binary Outputs.	322
6.2.12	Copying, Moving and Deleting Process Data	323
6.3	Measured and Metered Values.	325
6.3.1	Operational Measured Values.	326
6.3.2	Energy Counters	328
6.3.3	Setting Limit Points	329
6.3.4	Resetting Metered Values and Minimum/Maximum Values	331
6.3.5	Reading Out and Resetting User-defined Metered Values	332
6.4	Fault Recording Data	333
6.4.1	Reading out the Fault Recording Data	333
6.4.2	Saving the Fault Recording Data	336
6.5	Controlling Device Functions	337
6.5.1	Reading and Setting the Date/Time	338
6.5.2	Settings Group Change Option of the Functional Settings	343
6.5.3	Changing Information on the System Interface during Testing Operation	345
6.5.4	Changing Over the Operating Mode	347
6.5.5	Allocating an Operator Level to Function Keys.	347
6.6	Circuit Breaker Test Function	348
6.7	Control of Switchgear	352
6.7.1	Control by Means of a Higher-level Control System	353
6.7.2	Displaying the Switch Position and Switching.	353
6.7.3	Manual Overwriting	357
6.7.4	Set Status	358
6.7.5	Interlockings	360
6.7.6	Tagging	361
6.7.7	Switching Authority	362
6.7.8	Switching Mode	363
6.7.9	Control Indications	365
7	Communication	367
7.1	General	368
7.2	Establishing a Connection via Plug and Play	372
7.3	Establishing a Connection	374

7.4	Initializing a SIPROTEC 4 Device	376
7.5	Transmitting the Parameter Set	377
7.6	Direct Connection in Accordance with IEC 60870-5	378
7.6.1	Setting Communication Parameters	378
7.6.2	Establishing a Direct Connection between DIGSI 4 and the Device	381
7.6.3	Closing a Direct Connection	381
7.7	Central / Remote Control	382
7.7.1	Introduction	382
7.7.2	Central Control	382
7.7.3	Remote Control	382
7.7.4	Analog Modems	383
7.7.5	ISDN Modems (Terminal Adapter/Controller)	383
7.7.6	Ethernet Modems	383
7.7.7	SIPROTEC 3 Devices	383
7.7.8	SIPROTEC 4 Devices	384
7.7.9	SIPROTEC 3 and 4 Devices	384
7.7.10	V1/2 Protection Devices	384
7.7.11	Data Format/Secure Transmission	385
7.7.12	Approvals	385
7.7.13	Selection Criteria	385
7.7.14	Application Examples	387
7.8	PROFIBUS FMS	391
7.8.1	PROFIBUS FMS with SIMATIC NET Software 05/2000 + SP2	391
7.8.2	PROFIBUS FMS V6.1 with SIMATIC NET Software 11/2002 + SP1	414
7.8.3	Procedure with SIMATIC NET NCM PC Edition	437
7.9	Supplementary Protocols	439
7.9.1	Specifying the System Interface in DIGSI 4	440
7.9.2	Selecting and Editing a Mapping File	441
7.9.3	Allocating Information Items	443
7.10	Connection via Ethernet	446
8	Maintenance and Immediate Help, Test Functions	447
8.1	General	448
8.2	Routine Checks	449
8.3	Replacing the Battery	450
8.3.1	General	450
8.3.2	Battery Replacement at Panel Flush Mounted and Cubicle Mounted Devices	450
8.3.3	Battery Replacement for Devices with Detached Operator Panel	452
8.3.4	Battery Replacement for Panel Surface Mounted Devices	454
8.4	Test and Diagnostic Functions	456
8.4.1	Activating and De-activating the Test Mode	457
8.4.2	Activating and De-activating the Transmission Block	457
8.4.3	Testing Device Inputs and Outputs (Hardware Test)	458
8.4.4	Carrying Out a Circuit-breaker Test	460
8.4.5	Initiating a Test Fault Record	461
8.4.6	Outputting Indications	461
8.4.7	Displaying the System Load	462

8.5	Troubleshooting	463
8.6	Corrective Action / Repairs	465
8.6.1	Software Procedures	465
8.6.2	Hardware Procedures	465
8.7	Return	469
A	Appendix	471
A.1	Operating Instructions for DIGSI 4	472
A.2	Configuring Information Items - Overview	477
A.2.1	Indications	477
A.2.2	Commands	479
A.2.3	Measured Values	481
A.2.4	Metered Values	482
A.3	Plant Structure for Remote Operation Via Modem - Example	484
A.4	Wiring Diagrams for Connecting Cables	487
A.5	General Setting Hints for Modems	488
B	Appendix	491
B.1	Indications	492
B.2	Commands	493
	Literature, Glossary, Index	

System Overview

This chapter provides an overview of the family of SIPROTEC 4 devices and their integration into the control systems. It also describes the theoretical procedures for setting the device parameters and for performing general operations.

Contents

1.1	General	18
1.2	Communication	19
1.3	Operator Interface	23
1.4	Setting Parameters	25
1.5	Control Operations	29

1.1 General

The SIPROTEC 4 family is an innovative product series of numerical protective and control devices with open communication interfaces for remote control and remote parameter settings, ergonomically designed user interface and highly flexible functionality.

The devices utilize numerical measuring techniques. Completely numerical signal processing offers high measurement accuracy and long-term consistency as well as the reliable handling of harmonics and transients. Digital filter techniques and dynamic stabilization of measured values ensure the highest degree of security in determining the protective responses. Device errors are recognized and indicated rapidly by integrated self-monitoring routines. Failure of protection during a network fault is therefore almost entirely excluded.

You may choose devices with separate protective and process control functions, or select a solution that implements both requirements on the field level.

The following solutions are available:

- Protective and control functions in separate devices
- Protective devices that provide the capability of controlling the circuit breaker of the feeder through the communication interface,
- Devices with combined features that, in addition to protective devices, offer on-site operation for several switching devices and that provide extensive control functions.

1.2 Communication

SIPROTEC 4 devices completely fulfil the requirements of modern communication technology. They dispose of interfaces that allow for integration into higher-level control centers, comfortable parameter setting functions and operation via an on-site PC or via a modem connection.

SIPROTEC 4 devices support the following widespread, internationally accepted open communication standards:

- PROFIBUS FMS
- PROFIBUS DP
- IEC 60870-5-103
- DNP 3.00 Level 2
- MODBUS ASCII/RTU
- Ethernet connection according to IEC 61850



NOTE

Please refer to the device manual for further details on the communication standards available in your SIPROTEC device.

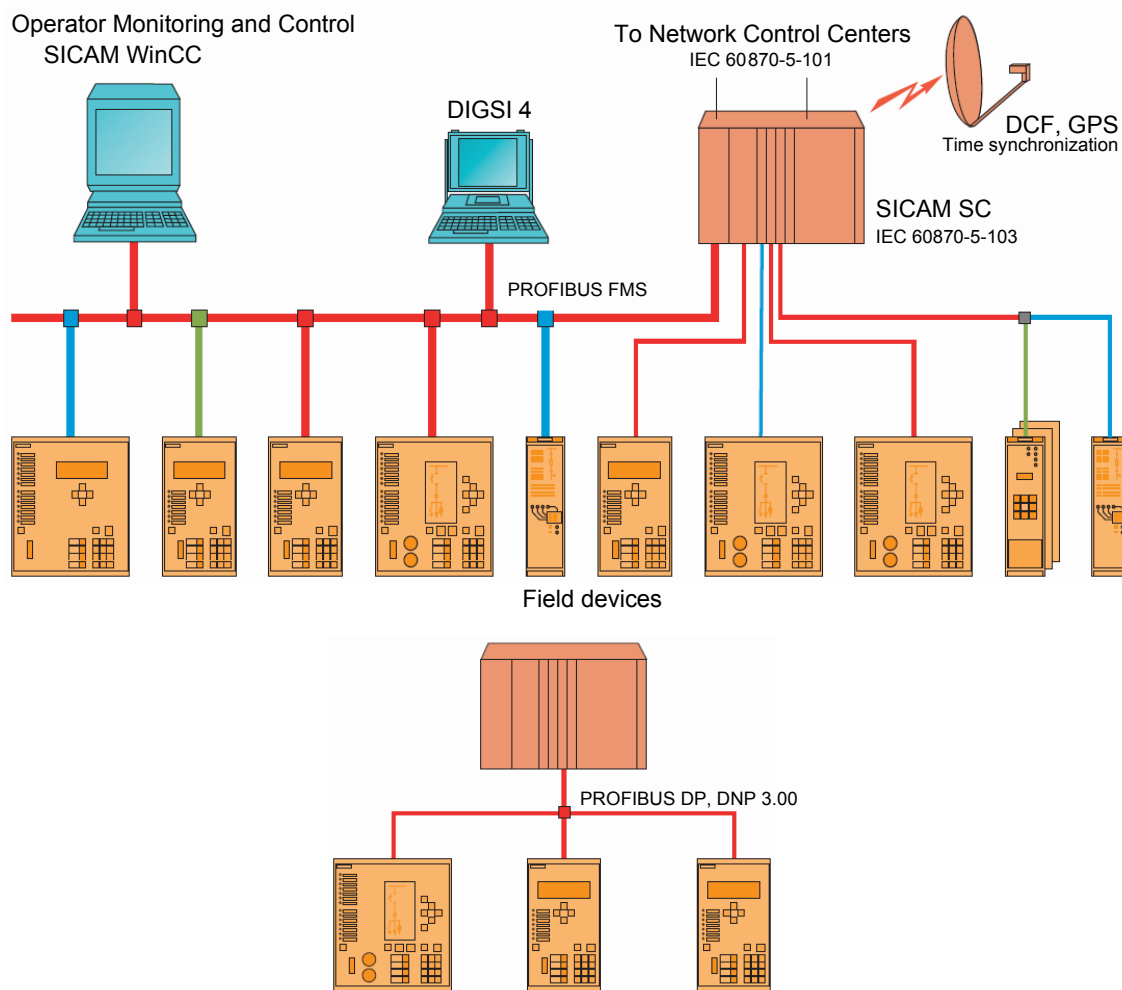

Fig. 1-1 Integration of field devices into a station control system - example

In the above sample configuration the data transmitted from the field devices in the **monitoring direction** can be processed in the station control device SICAM SC, displayed at the operator monitoring and control station SICAM WinCC and passed via the remote control interface to the higher-level control center.

In the **command direction** equally flexible processing is possible, that is switching operations can be initiated both from the network control center as well as from the monitoring and control unit of the station control system.



NOTE

All the SIPROTEC 4 devices also operate with a star coupler. Thus, for simple applications, you can retrieve all the information from your office or while on the road.

The PROFIBUS DP protocol facilitates the inclusion of SIPROTEC 4 devices in PLC-based process control systems (for example SIMATIC S5/S7). The DNP 3.00 and MODBUS ASCII/RTU protocols also allow the inclusion in a wide range of control systems of other manufacturers.

1.2.1 Time Synchronization

Time control in your SIPROTEC 4 devices can be implemented by using:

- ❑ DCF77 Radio Receiver (time signal from the PTB Braunschweig),
- ❑ IRIG B Radio Receiver (time signal from the global positioning satellite (GPS) system),
- ❑ Messages from a system interface (for example from a control center),
- ❑ Radio clock using a plant-specific synchronizer box,
- ❑ Minute pulses on a binary input,

The time synchronization possibilities depend on the protocol used and are listed in the table **Protocol-Dependent Functions** in the appendix of the device manuals.

The parameters are set exclusively by means of the parameter setting interface of DIGSI 4.

1.2.2 Serial Interfaces

Devices of the SIPROTEC 4 family can be equipped with further external interfaces in addition to an interface for time synchronization.

- ❑ The device is connected to higher-level control centers via the **system interface**. The following protocols are available depending on the device type and design:
 - IEC 60870-5-103
 - PROFIBUS FMS
 - PROFIBUS DP
 - DNP 3.00 Level 2
 - MODBUS ASCII/RTU
 - Ethernet connection according to IEC 61850
- ❑ A radio clock is connected via the **time control interface** (see Section 1.2.1).
- ❑ The remote diagnostic facility, for example DIGSI 4, is connected via modem and/or star coupler to the **service interface**. All DIGSI 4 operations are possible via this interface.
- ❑ The **operator interface** on the front of the device is used for on-site connection of a PC on which DIGSI 4 is installed. This interface allows, for example, to load the parameter settings of the device, and to carry out all operations which are possible with DIGSI 4, such as reading out fault records or operational indications.
- ❑ Depending on the device model additional **interfaces for specific applications** are available, for example for differential protection applications or Inter Relay Communication on the field level.

In the dialog boxes of the DIGSI 4 parameter setting of **interfaces** you can specify e.g. the settings for

- Transmission protocols and
- Transmission speeds.



NOTE

The system interface can be equipped with different modules for connection to other devices, for example via optical fibers, RS485 or RS232 interface.

1.3 Operator Interface

Your SIPROTEC device can be operated via

- ❑ The **control panel** on the front of the device or
- ❑ The DIGSI 4 user interface of your PC which is connected on-site to the operator interface of the device or via modem and service interface.

1.3.1 Operator Control Panels

The operator control panel of the SIPROTEC 4 devices, which is ergonomically designed and easy to read, allows on-site control operations to be carried out, individual device parameter settings to be effected and all the information required for operations to be displayed.

The operator control panels of the devices contain either a **graphical** or a **4-line display**, depending on the specific device type.

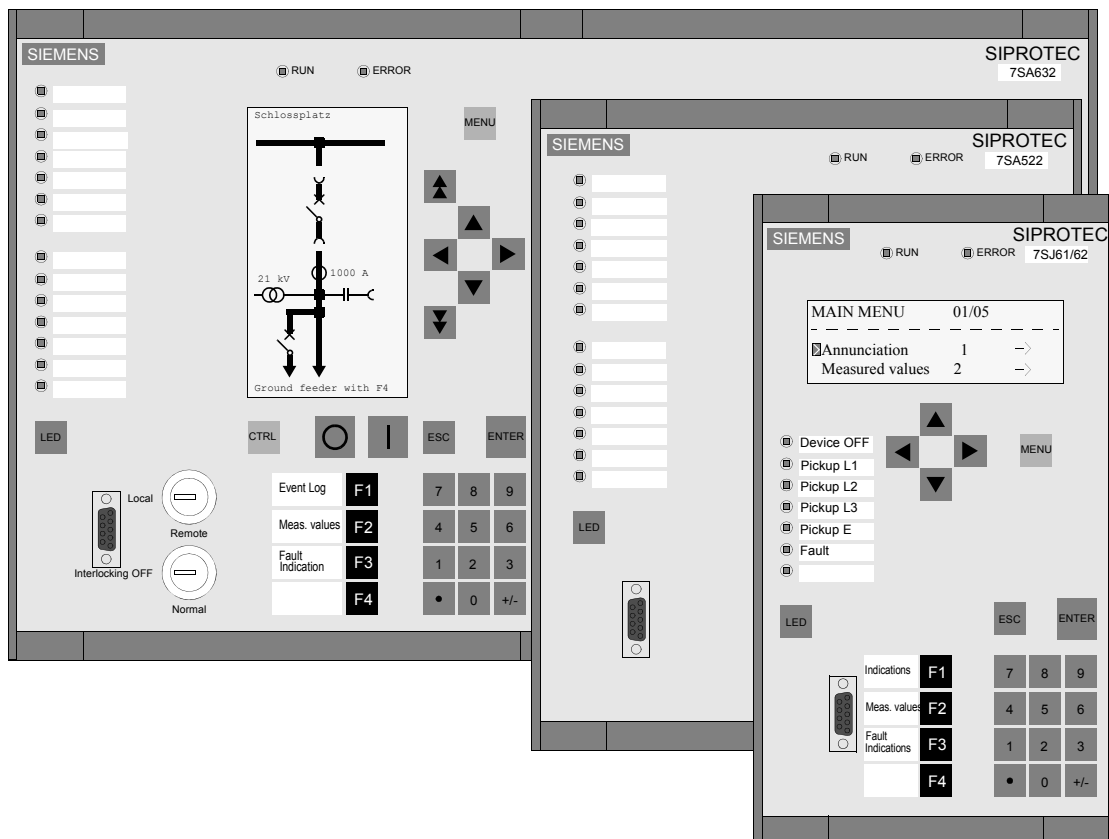

Fig. 1-2 SIPROTEC 4 devices, operator control panel, examples

1.3.2 DIGSI 4

DIGSI 4 is used to set parameters and operate your SIPROTEC devices via your PC.

Operator Guidance

DIGSI 4 uses the Window technique common for PC applications for the operator guidance. You are therefore in a familiar system environment.

While configuring or operating a SIPROTEC device with DIGSI 4, only the parameters relevant to the specified device are available.

Entering parameter settings for SIPROTEC devices is easy thanks to many types of assistance such as context menus, drop-down lists for the selection of available options and specification of the limits for the entry of numerical values or tooltips.

Configuration Matrix

The items of information are interlinked by means of a matrix which presents the items of information of your plant in an easy-to-read manner thanks to individual settings and filter functions. This means that you can have specific information sections displayed which you require for partial parameter setting.

Passwords

Access authorization by means of passwords protects the individual tasks, such as setting parameters, executing control commands or tests and diagnostic functions against unauthorized access.

Commissioning Aids

DIGSI 4 facilitates commissioning by means of switchgear tests functions, testing of the inputs and outputs or measured-value simulation.

Help System

The help system explains the individual functions and parameters, thus providing additional support.

1.4 Setting Parameters

The SIPROTEC 4 devices are supplied with default parameter settings, and are thus ready-to-operate.

The DIGSI 4 system component offers you a user-oriented interface and logically consistent operator guidance for the individual parameter setting and configuration of your field devices.

DIGSI 4 is installed on a normal personal computer which is, for example, connected to the operating interface on the front of the device.

The parameters are set **offline**. The generated data is then downloaded locally via the **operating interface** or remotely via modem and the **service interface** of the SIPROTEC 4 device.

During online mode changes to the configured parameters are protected by **password**.

The **parameter setting** procedure of a SIPROTEC 4 device consists of:

- Overall protection and control design** with
 - Determination of the functional scope,
 - Configuration of the information,
 - Definition of the user-definable logic functions (CFC).
- Function settings** with
 - General settings,
 - Settings of the protective functions,
 - Settings of the process control functions.

In order to change **individual function parameters**, such as protective settings, during operation, you can use either DIGSI 4 or the **operator control panel** of your SIPROTEC 4 device in the Settings mode.

You can control other parameter setting functions such as configuration, functional scope or the interface definition via the operator control panel, however not change them.

Online changes of the individual parameters are protected by a **password**.

1.4.1 Functional Scope

The individual devices SIPROTEC 4 device family are available with different functional scopes. When ordering your device you already carry out a preselection of the functions, which you specify more precisely later on with DIGSI 4.

Instanceable Functions

Some protective functions are found several times in a device. To set their parameters easily and flexibly, several instances of these functions are available which can be selected with a mouse click (for details refer to the Online Help of DIGSI 4).

Settings Groups

See chapter 5.4.

1.4.2 Configuration

In the **Configuration** setting step you use a matrix to specify how your individual items of information are configured to the inputs and outputs.

Configuration is carried out by means of DIGSI 4.

1.4.3 Programmable Logic CFC

The DIGSI 4 CFC program is used to create logic operations in graphical form, such as interlock conditions or limit monitoring of measured values.

Device-specific CFC functions are in some cases implemented in the basic parameter settings at the factory.

The generic logic blocks provided (AND, OR, NAND, etc.) and the analog blocks created specially for the requirements of process control (for example UPPER_SETPOINT, LOWER_SETPOINT, etc.) can be used to create your own logic operations.

The blocks are interconnected to CFC programs which, for example,

- Perform plant-specific checks,
- Generate indications when measured values approach a critical range or
- Form group messages for transfer to higher-level control centers.

1.4.4 Power System Data

Your plant-specific parameters are specified in the dialog box during the parameter setting process. The power system data include

- System data such as frequency, voltage, etc.
- Data of the main current transformers and voltage transformers,
- Data of the circuit breaker in the feeder.

Some SIPROTEC 4 devices do not have all these values, e.g. 6MD66 has only the nominal frequency.

Individual power system data is part of the various settings groups which can be switched over during operation in the context of the settings group changeover. They include, for example:

- Primary rated operating voltage
- Primary rated operating current
- Characteristic data of the protected object

1.4.5 Settings Groups

The settings of the SIPROTEC 4 devices can be divided into up to four different configurations, the **Settings groups A to D**. This provides you with the comfortable possibility of switching over to different parameter settings for the device depending on the switching state of the system.

These settings are saved and can be switched over during operation by means of DIGSI 4, at the operator control panel of the device, via binary inputs or via the serial system interface.



NOTE

Settings that are used in common by all the protective functions of a settings group are saved under **Power System Data 2**.

Some SIPROTEC 4 devices (e.g. 6MD63, 6MD66 and 6MD665) have no settings groups.

1.4.6 Passwords

You can assign **passwords** in order to protect your SIPROTEC device against unintended changes to the device or unauthorized operations from the device.

The following **access authorizations** are preset at the factory:

- Switching/tagging/updating (Password No. 1)
- Unlocked switching (Password No. 2)
- Test and diagnostics (Password No. 4)
- Hardware test menus (Password No. 6)
- Single parameters (Password No. 5)
- Parameter set (Password No. 7)

Web Monitor

- Access authorization "Full access" (only for SIPROTEC B&B)
- Access authorization "Changes" (only for SIPROTEC B&B)
- Access authorization "Read only" (only for SIPROTEC B&B)

The password is requested for a function when a corresponding control operation is performed with DIGSI 4 or at the operator control panel of the SIPROTEC device.

Password protection against unauthorized access is only active during **online** operation. The passwords for changing settings are not activated until the settings are downloaded to the device. They are irrelevant in the DIGSI 4 offline mode.

In order to **de-activate** a password you have to know it!



NOTE

- Passwords are numbers with a length of up to 8 digits.
At delivery all passwords are set by default to **000000**. The passwords for the Web Monitor are an exception: Here the default setting is **000002** for "Full access", **000001** for "Changes" and **000000** for "Read only".
- For Web Monitor access the following settings apply:

Operator interface	Read only
Service interface	Read only
System interface	No access

 You have to explicitly change these settings in order to be able to access the SIPROTEC device, e.g. with the Web Monitor.



NOTE

If you have forgotten your password for changing a parameter set, a temporary password can be obtained from our hotline. This can be used to define a new user password for this function. Our hotline requires the **registration number** of your **DIGSI 4** software package!

1.5 Control Operations

The SIPROTEC 4 device family offers various options to obtain an overview of the current operating state of your plant or to carry out control interventions. You have access via

- Control centers (remote)
- The operator control panel (local)
- The DIGSI 4 user interface (local or remote)

Control Center

If the device is included in a control center system, information can be transferred to the control system via a connection to the **system interface** of the SIPROTEC 4. It is furthermore possible to trigger commands remotely from the control system via messages.

SIPROTEC 4 devices can be connected to

- Higher-level control centers or
- Station control devices, for example SICAM SC.

Operator Control Panel

Locally the SIPROTEC 4 device offers you the possibility of reading out information or of controlling via the **operator control panel** of the device.

DIGSI 4

If you want to read out information via the DIGSI 4 user interface,

- Connect your PC locally to the **operator interface** of the device or
- Communicate with your SIPROTEC 4 device in on-line mode via the modem and **service interface** .

1.5.1 Indications

The configuration of the SIPROTEC 4's functional scope also determines its scope of indications.

The indications are displayed via **DIGSI 4** or via the **operator control panel** of the device.

DIGSI 4 has the following indication groups:

- Event Log (operational indications),
Indications independent of network faults, for example indications on switching operations or monitoring functions
- Trip Log (fault indications),
for example indications of short circuits, etc.
- Sensitive Ground Fault Log,
(in devices with ground-fault indication)
- General interrogation,
Display of present state messages
- Spontaneous annunciations,
Continuous display of important device indications, for example after faults or switching operations, etc.

The device display differentiates between

- Event Log
- Trip Log
- Sensitive Ground Fault Log
- Spontaneous annunciations
Automatically displayed fault indications after general device pickup

1.5.2 Measured Values

The detected measured values are divided into the following categories and displayed via DIGSI 4 or via the **operator control panel** of the devices, for example:

- Primary values, calculated from the measured secondary values in accordance with the set transformer data and nominal values
- Secondary values, measured values
- Percentage values, related to the set nominal values
- Further values which are calculated by the device
- Statistic values, for example number of switching operations of the circuit-breaker

1.5.3 Fault Records

The SIPROTEC 4 devices record a configurable number of measured values and indications in the event of operating faults.

These fault data is read out of the device memory by DIGSI 4 and saved as fault value records in standardized COMTRADE format.

The **SIGRA 4** system components provide comfortable possibilities of evaluating these fault value records graphically.

SIGRA 4 calculates additional values from the recorded values, for example impedances, and presents the measured and calculated values in

- Time signal diagrams,
- Vector diagrams,
- Circle diagrams,
- Harmonic views.

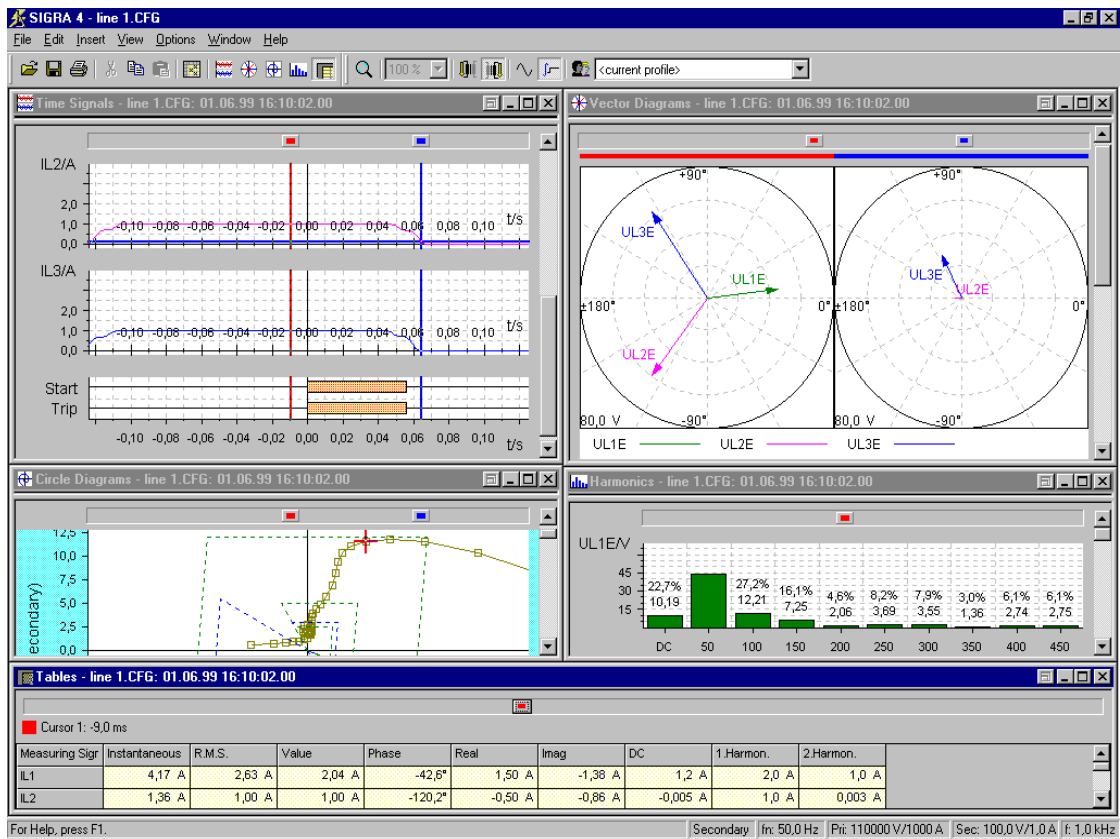

digra009.gif

Fig. 1-3 SIGRA 4 Fault record evaluation, example

1.5.4 Controlling / Manual Updating Equipment

Controlling

The many application possibilities of the SIPROTEC 4 devices also require a flexible concept for command processing.

In addition to different means of outputting the command via the operator control field or via a message of a higher-level control center, the **DIGSI 4 CFC** graphical configuration system offers you the possibility of linking items of information and deriving a command output from the result of logic operations. These results of logic operations are configured to the outputs of the device and processed in accordance with the parameter setting.

Command outputs are subject to **interlocking checks** which you can also configure individually with DIGSI 4 CFC. Standard interlocks, such as switchgear interlocking or feeder grounded, are partially included in the supplied basic parameter settings.

The command output time, feedback monitoring time, etc. are specified in the context of the parameter setting function.

All switching operations are logged in the message lists with the date and time.

Switching operations may only be carried out by authorized personnel and are therefore protected by **passwords!**

Manual update

If the transmission of the switch position indications is interrupted, you can set the switching state of your switching means manually via the operator control panel to the current switching state by means of the **Manual update** function. This switching state is taken into consideration for interlocking checks and at automatically triggered switching operations.

Set Status

During commissioning it can be advisable to interrupt the information exchange between the switch and device briefly without having to disconnect the connection physically. This function of the device, **Set status**, is activated by means of the operator control panel.

1.5.5 Setting Taggings

In order to identify unusual operational statuses in your plant you can set **taggings**.

To this purpose a new internal single-point indication can be defined which represents the plant state, for example grounded. This internal single-point indication can then be taken into consideration in the interlocking checks which you configure individually with CFC. Taggings are configured like devices.



NOTE

Please refer to the device manuals for further details on the functionality of your device, on the individual parameters and on the display structure of the plant data.



The SIPROTEC Devices

This chapter contains information on the operating and display elements of the operator control panels, design, termination system and housing variants of a SIPROTEC 4 device. In addition you will find information on the recommended and permissible data for the wiring as well as on suitable accessories and tools.

Contents

2.1	Operator Control Panels of the Devices	34
2.2	Device Types for Panel Flush Mounting and Cubicle Flush Mounting	24
2.3	Device Types for Panel Surface Mounting	42
2.4	Device Types with Detached Operator Control Panel	46
2.6	Connections with Screw Terminals - Panel Flush Mounting	50
2.7	Connections with Screw Terminals - Panel Surface Mounting	56
2.8	Connections for Plug-in Terminals	57
2.9	Connections for Optical Fibers - Panel Flush Mounting	61
2.10	Connections for Optical Fibers - Panel Surface Mounting	62
2.11	Connections for Electrical Serial Interfaces	65
2.12	Connections for Analog Output	67
2.13	Connections for Low-level Signal Converter	69

2.1 Operator Control Panels of the Devices

Depending on their functionality, SIPROTEC devices are equipped with an operator control panel with

- 4-line display or
- Graphical display.

Depending on the device type, the indication and control elements may differ. For example, switching operations which are protected by keyswitches can be triggered via the control display in the case of devices with graphical display. The devices are equipped with different numbers of LEDs in order to display selectable information via LEDs.

2.1.1 Operator Control Panel with 4-line Display

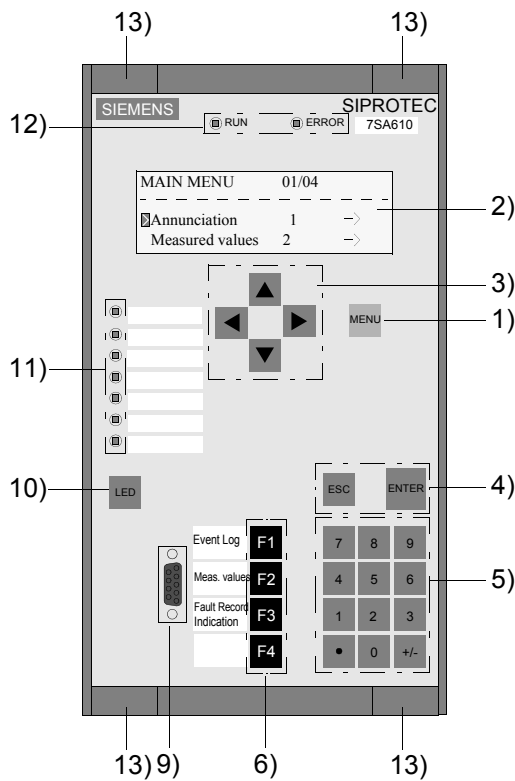

Fig. 2-1 Example of front view, housing size $\frac{1}{3}$

The meaning of the indication and control elements is described in the subsequent chapters.

2.1.2 Operator Control Panel with Graphical Display

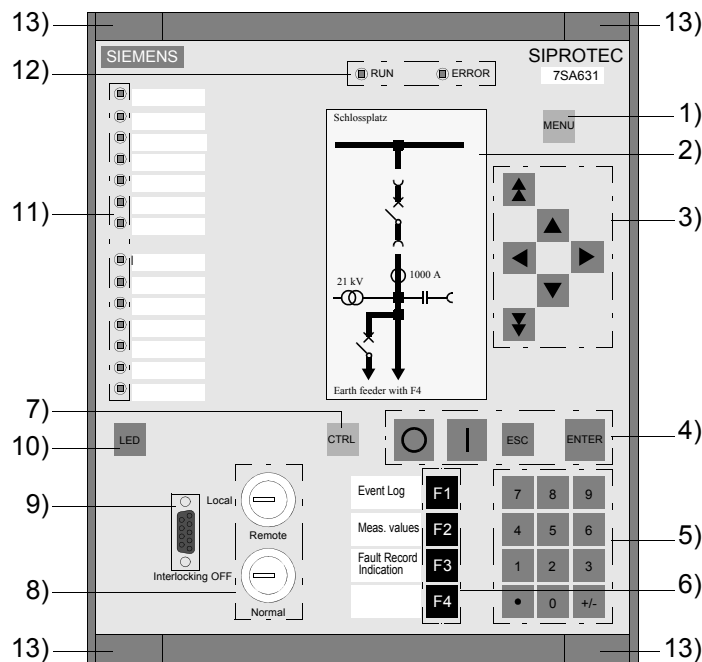

Fig. 2-2 Example of front view, housing size $1\frac{1}{2}$

Indication Elements

- LCD indication field (2)
For the display of process and device information as a control display or as a text in various lists.
Frequently displayed information includes the position of the switching device and other process elements, measured values, metered values, binary information on the state of the bay and of the device, protective information, general indications and alarms.
- LEDs (11)
Freely configurable LED for displaying any process or device information. The front panel contains a labelling strip next to the LEDs suitable for custom labelling.
- Operating state indications (12)
"RUN" and "ERROR"

Keyswitches

- Keyswitches (8)
Keyswitches ensure rapid and secure access to switchover functions between **local and remote control** and **locked and unlocked operation**.

Operator Interface

- 9-pin Dsubminiature female connector (9)
The female connector is used to connect a PC which operates the SIPROTEC device via DIGSI 4

Front Panel Fixture

- Cover for the screws which fasten the front panel (13)

2.1.3 Keys of the Operator Control Panels

Depending on the version of your SIPROTEC device the operator control panel has the following keys:

Table 2-1 Keys on the operator control panel of a SIPROTEC device















Key	Function/Meaning
	MENU key used to open the main menu (1)
	Paging key for navigating in the menus or in the control display (3)
	Paging key for navigating in the menus or in the control display (3)
	Paging key for navigating in the menus or in the control display (3)
	Paging key for navigating in the menus or in the control display (3)
	Paging key for navigating in the menus or in the control display (3)
	Paging key for navigating in the menus or in the control display (3)
	Confirm inputs (4)

Table 2-1 Keys on the operator control panel of a SIPROTEC device

Key	Function/Meaning
	Reject entries, jump back (4)
	Numerical keys 0 to 9, full stop and sign for entering numerical values (5)
	<p>Function keys F1 to F4 (6)</p> <p>Function keys allow you to rapidly and simply carry out actions which are carried out often. They can be programmed freely.</p> <p>In the front panel there is a labelling strip for the user-specific labelling next to the keys. Typical applications for them include jumps to a certain position in the menu tree.</p> <p>3 of the keys have a factory-preset assignment used to display the following lists:</p> <p>F1 Operational indications F2 Operational measured values F3 Fault indications of the last fault record</p>
	Display of the control display (7)
	<p>Test of the LEDs</p> <p>Resetting the LED memory and binary outputs (10)</p>
	ON key for controlling the process (4)
	OFF key for controlling the process (4)

**NOTE**

The use of the operator control panel of the device is described in Chapter 3.3 and Chapter 6.

2.2 Device Types for Panel Flush Mounting and Cubicle Mounting

SIPROTEC devices for panel flush mounting and cubicle mounting are closed devices in a 7XP20 housing. They are available in three **housing sizes**:

- $\frac{1}{3}$ of 19 inch with 4-line display
- $\frac{1}{2}$ of 19 inch with 4-line display or graphical display
- $\frac{1}{1}$ of 19 inch with 4-line display or graphical display

Various termination systems are possible depending on the variant ordered.

2.2.1 Housing

The housing is equipped with a device-specific rear plate and a front panel. Guiding mats are mounted inside the housing on the top and the bottom. The modules are mounted on these mats. Each guiding mat has visible numbering from 1 to 42 to indicate the module slots. The modules are interconnected and connected with the front panel by means of ribbon cables with connectors. The rear panel screwed onto the housing contains the terminal blocks required for the connections of the device.

The front panel is removable

- First remove the four covers in the corners and loosen the four screws which are then visible.
- Devices of housing size $\frac{1}{1}$ have two additional covers that have to be removed. These are positioned at the top and bottom center in the front panel frame. Also loosen the screws positioned under them.

The front cover includes a membrane keyboard with the operating and display elements necessary to operate the device. All lines of the operating and display elements are grouped together by means of a converter module in the front cover and routed through a connector to the processor module (CPU).

There is one nameplate sticker each with the most important device data, such as the auxiliary voltage, test voltages and order number (MLFB), on the device top and the inside of the front panel.

The dimensioned drawings of your SIPROTEC device are included in the device manual.

2.2.2 Front and Rear View of the Device Variants

The indication and control elements are explained in Chapter 2.1.

The rear plate is shown in simplified form with an example of the screw terminal configuration.

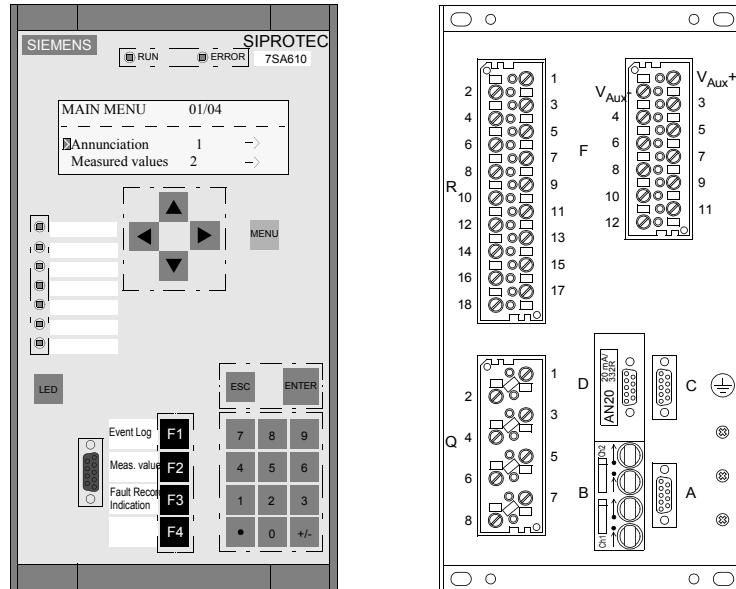

Fig. 2-3 4-line display, housing size $\frac{1}{3}$, example for panel flush mounting and cubicle mounting

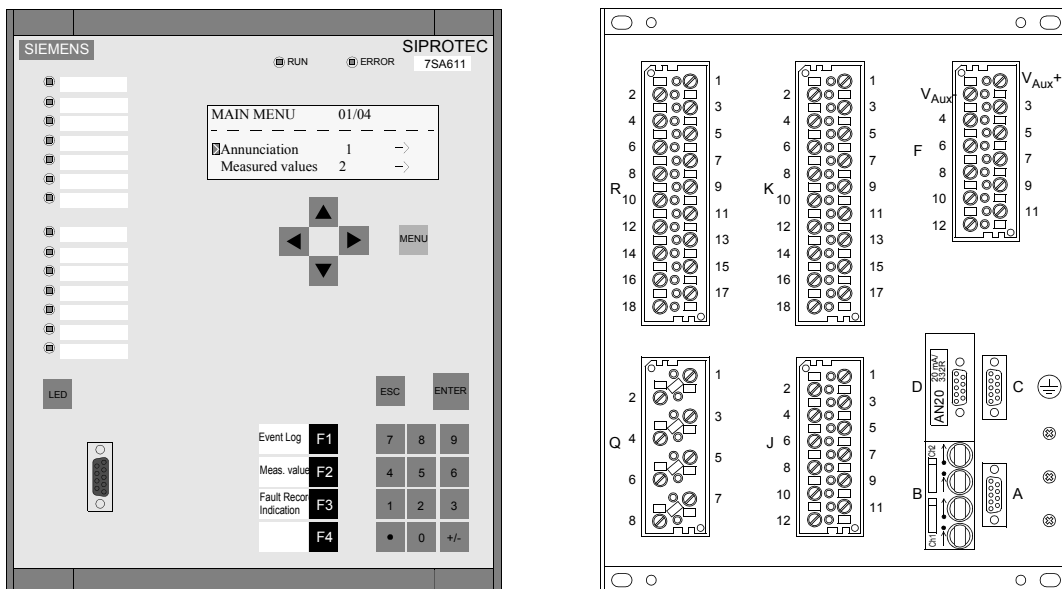

Fig. 2-4 4-line display, housing size $\frac{1}{2}$, example for panel flush mounting and cubicle mounting

2.2 Device Types for Panel Flush Mounting and Cubicle Mounting

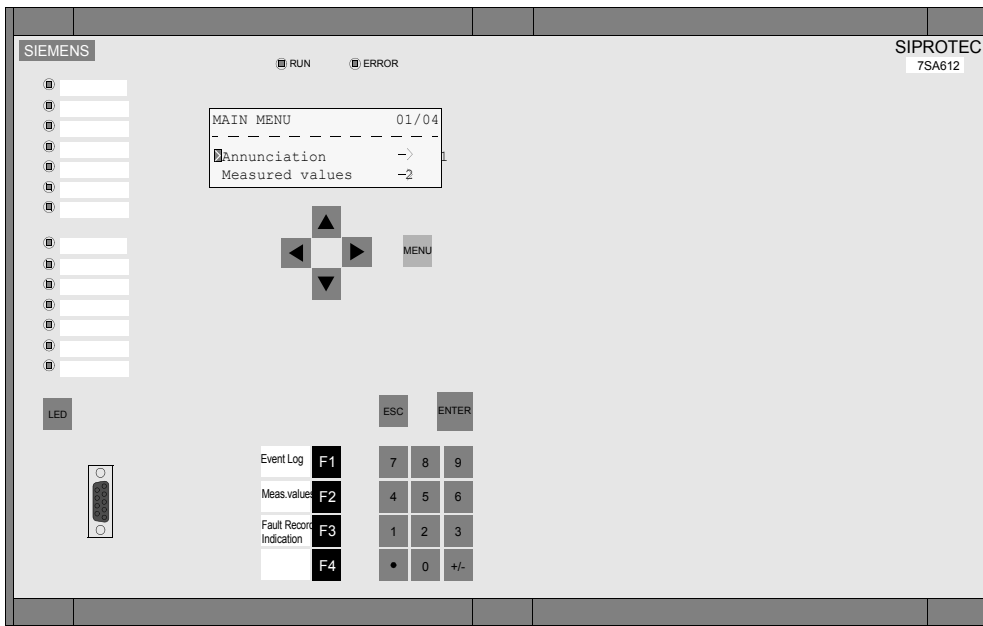

Fig. 2-5 4-line display, housing size $1\frac{1}{4}$, example for panel flush mounting and cubicle mounting

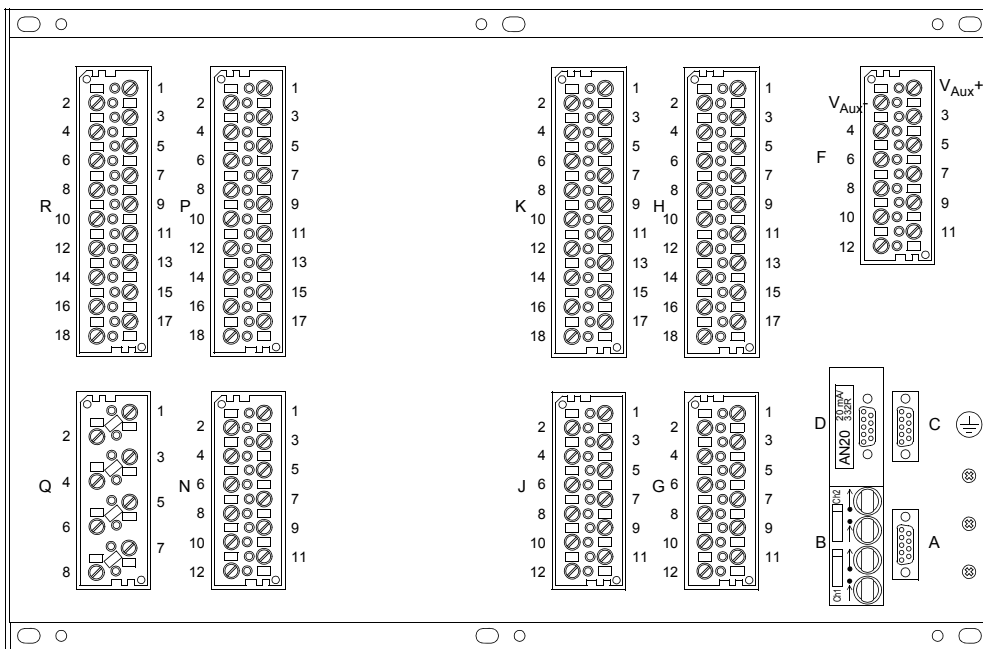

Fig. 2-6 Example of rear view, housing size $1\frac{1}{4}$

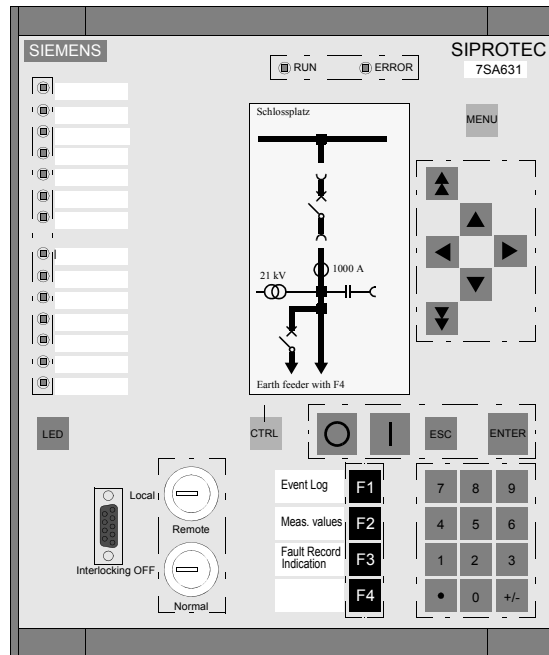

Fig. 2-7 Graphical display, housing size $1/2$, example for panel flush mounting and cubicle mounting

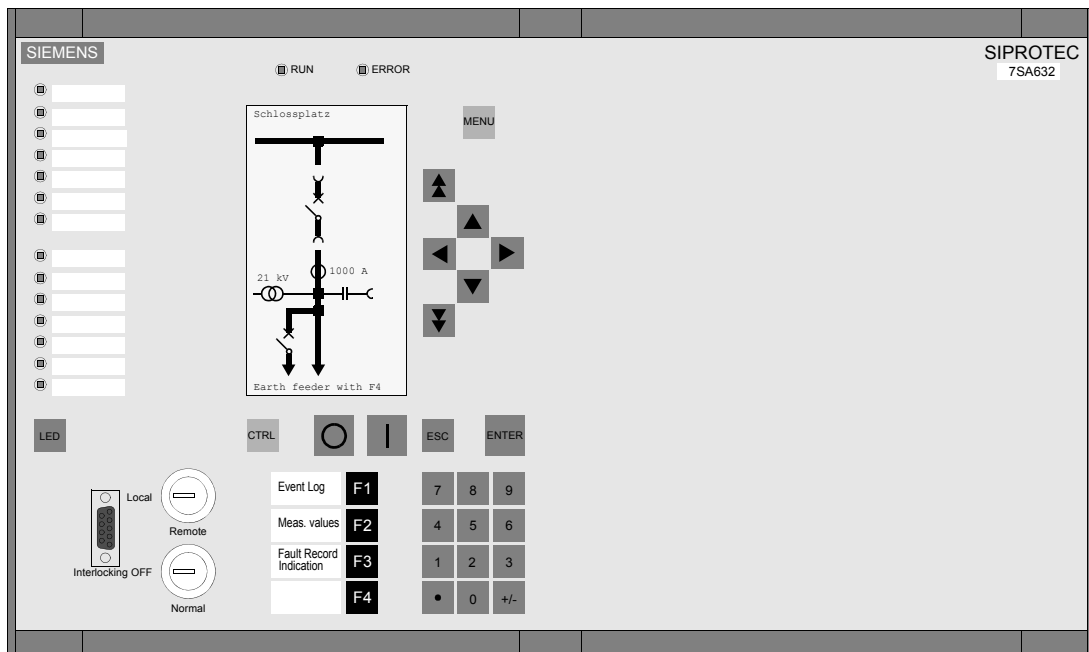

Fig. 2-8 Graphical display, housing size $1/1$, example for panel flush mounting and cubicle mounting

2.3 Device Types for Panel Surface Mounting

SIPROTEC 4 devices for panel surface mounting are closed devices in a 7XP20 housing. They are available in three **housing sizes**:

- $\frac{1}{3}$ of 19 inch with 4-line display
- $\frac{1}{2}$ of 19 inch with 4-line display or graphical display
- $\frac{1}{1}$ of 19 inch with 4-line display or graphical display

The device is installed in a surface-mounted housing.

2.3.1 Housing

SIPROTEC 4 devices for panel surface mounting essentially differ from devices for panel flush mounting by the positioning of the **two-tier terminals** for connecting the device. On devices for panel surface mounting these are positioned so that they are accessible from the front of the device (see Figure 2-9 to Figure 2-13).

The surface-mounted housing contains the wiring from the device-specific rear plate to the terminals.

The front panel can be removed from the front.

- First remove the four covers in the corners and loosen the four screws which are then visible.
- Devices of housing size $\frac{1}{1}$ have two additional covers that have to be removed. These are positioned at the top and bottom center in the front panel frame. Also loosen the screws positioned under them.

The front cover includes a membrane keyboard with the operating and display elements necessary to operate the device. All lines of the operating and display elements are grouped together by means of a converter module in the front cover and routed through a connector to the processor module (CPU).

There is one nameplate sticker each with the most important device data, such as the auxiliary voltage, test voltages and order number (MLFB), on the device top and the inside of the front panel.

The dimensioned drawings of your SIPROTEC device are included in the device manual.

2.3.2 Front View of the Device Variants

The indication and control elements are explained in Chapter 2.1.

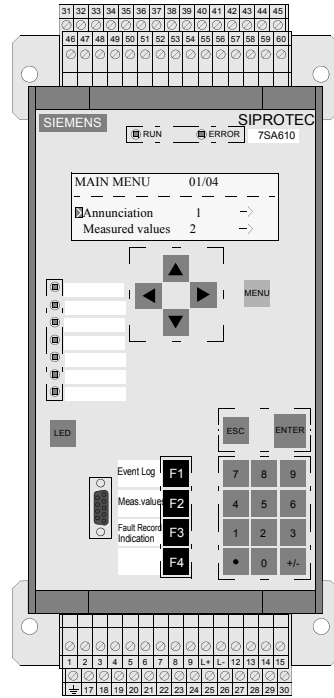

Fig. 2-9 4-line display, housing size $1/3$, example for panel surface mounting without optical-fiber connections

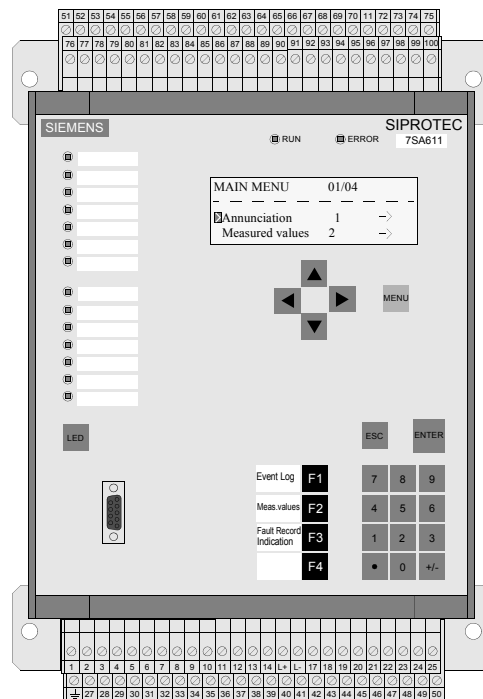

Fig. 2-10 4-line display, housing size $1/2$, example for panel surface mounting without optical-fiber connections

2.3 Device Types for Panel Surface Mounting

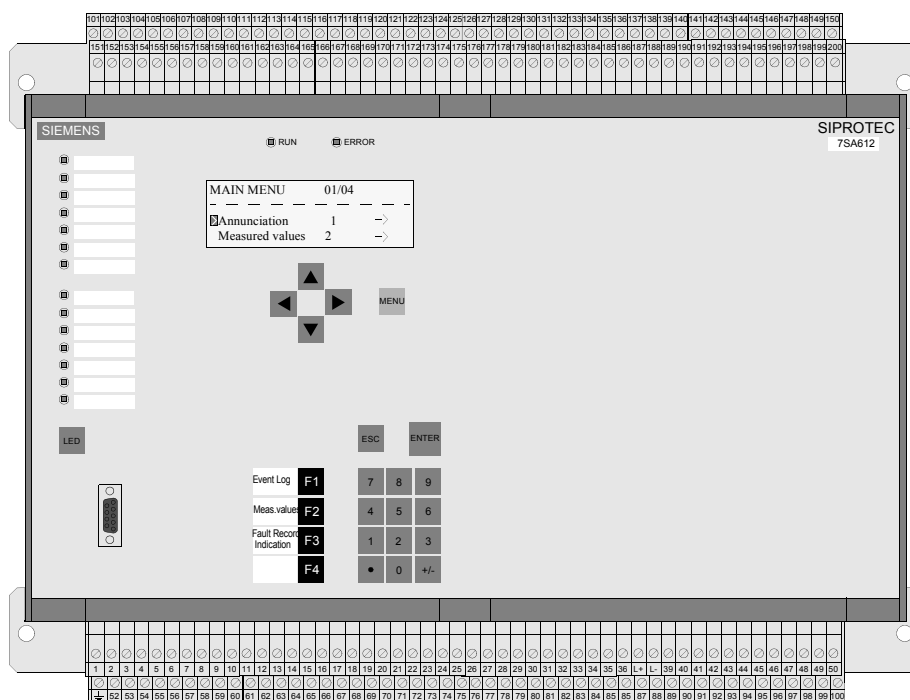

Fig. 2-11 4-line display, housing size $1/4$, example for panel surface mounting without optical-fiber connections

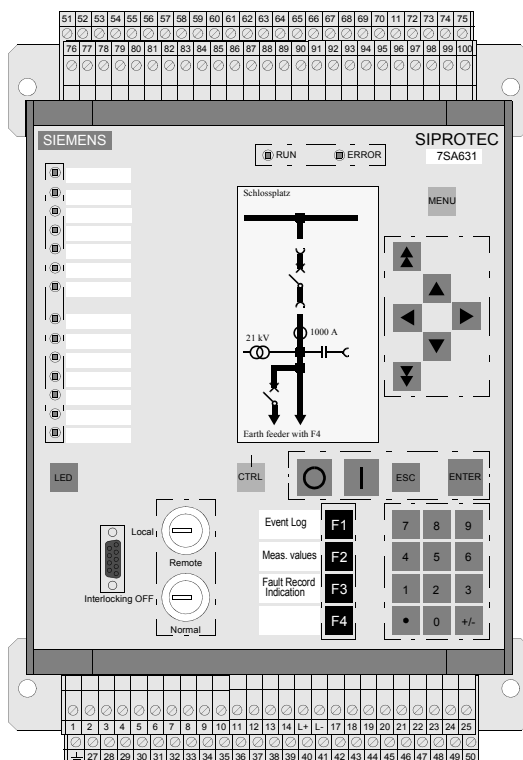

Fig. 2-12 Graphical display, housing size $1/2$, example for panel surface mounting without optical-fiber connections

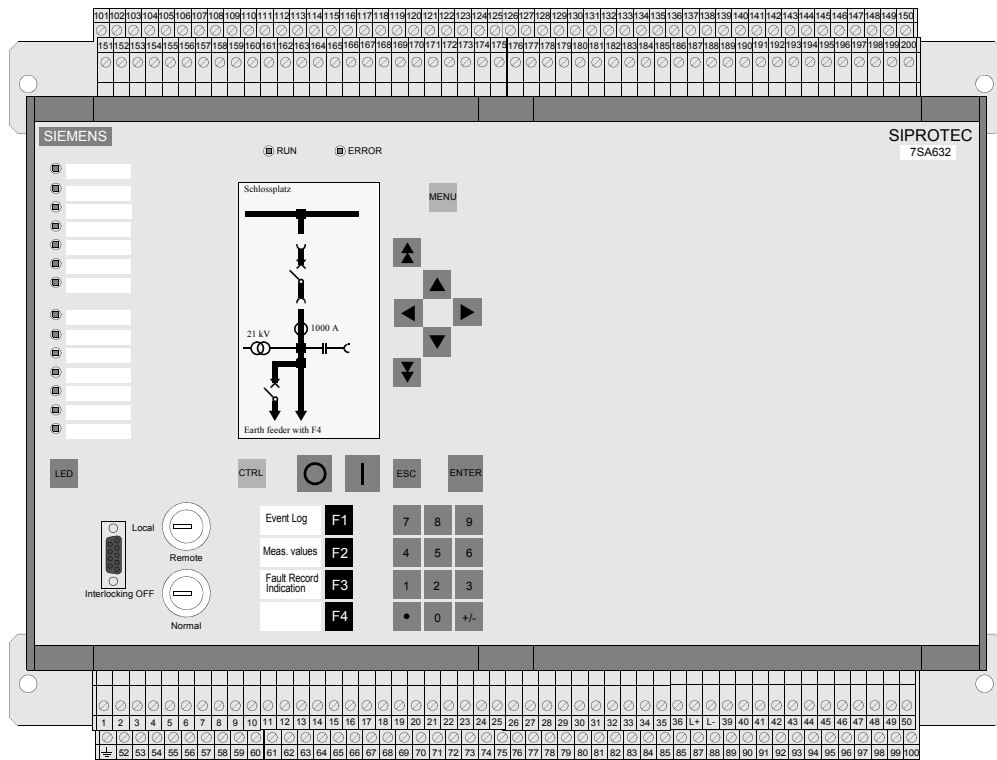

Fig. 2-13 Graphical display, housing size 1/1, example for panel surface mounting without optical-fiber connections

2.4 Device Types with Detached Operator Control Panel

SIPROTEC devices with detached operator control panel are intended for installation in a low-voltage box. They consist of a device in a 7XP20 housing in the housing size $1/2$ or $1/1$ (of 19 inch) for rear installation and an operator control unit for installation in a mounting panel.

The connection between the housing and the operator control panel is implemented by means of a cable set which is part of the operator control panel (see Fig. 2-14 and 2-15).

Various termination systems are available depending on the variant ordered.

2.4.1 Housing and Operating Unit

Housing

The housing is equipped with a device-specific rear plate and a front panel without indication and control elements. Guiding mats are mounted inside the housing on the top and the bottom. The modules are mounted on these mats. Each guiding mat has visible numbering from 1 to 42 to indicate the module slots. The modules are interconnected and connected with the front cover by means of ribbon cables with connectors. The rear panel screwed onto the housing contains the terminal blocks required for the connections of the device.

There is one nameplate sticker each with the most important device data, such as the auxiliary voltage, test voltages and order number (MLFB), on the device top and the inside of the front panel.

The housing is mounted at the top and bottom by means of a bracket with 3 holes for the housing size $1/2$ and 5 holes for the housing size $1/1$.

Operator Control Panel

The operator control panel consists of a front cover and a housing. The front cover includes a membrane keyboard with the operating and display elements necessary to operate the device. In the housing, the cable for connection with the device is connected to the membrane keyboard through connectors.

Before mounting the operator control panel in the mounting panel, you must first remove the four caps in the corners of the front cover. Mounting is then possible using suitable screws in the elongated holes that then become visible.

The indication and control elements are explained in Chapter 2.1.

2.4.2 Views of Operator Control Unit and Devices - Variants

The following figures schematically show SIPROTEC 4 devices with detached operator control panel, housing with plug-in terminals or screw terminals and connecting cables in the housing sizes $1/2$ and $1/1$.

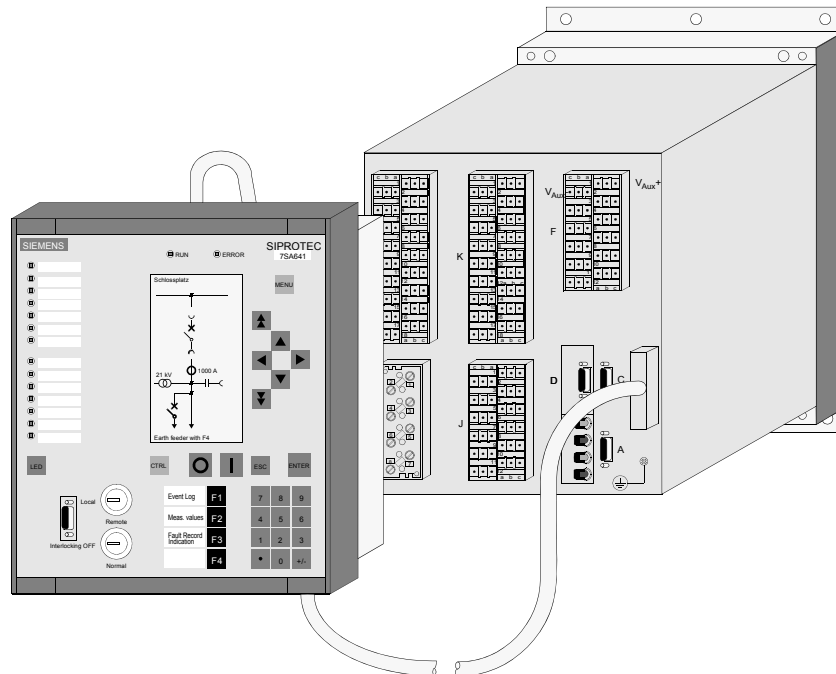

Fig. 2-14 SIPROTEC 4 device with detached operator control panel, housing size $1/2$, example

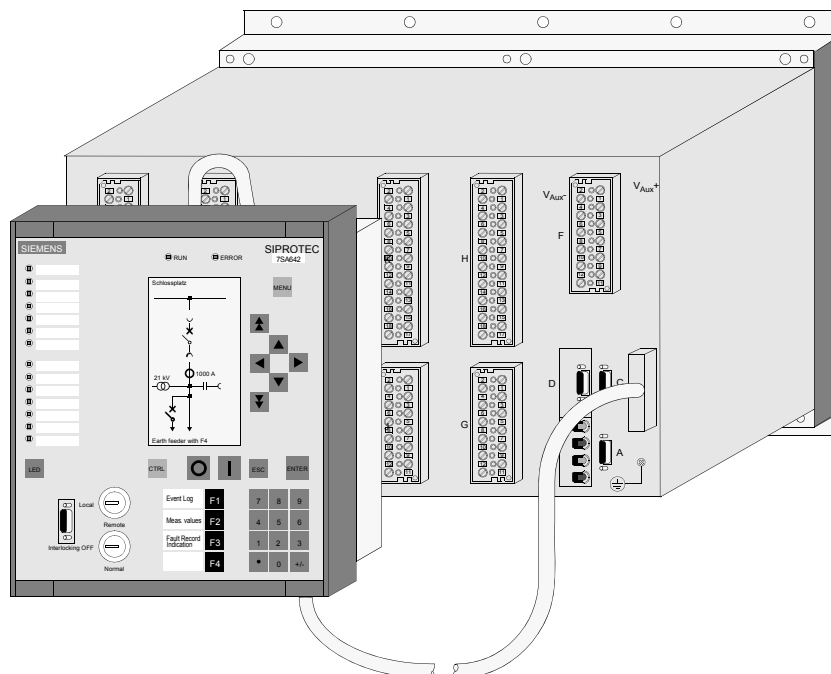

Fig. 2-15 SIPROTEC 4 device with detached operator control panel, housing size $1/1$, example

2.5 Device Type Surface-mounted Housing without Operator Control Panel

The SIPROTEC 4 device without operator control panel is designed for installation in a low-voltage box. It consists of a device in a 7XP20 housing in the housing size $1/2$ or $1/1$ (of 19 inch) for installation on a mounting panel and a dongle cable.

Various termination systems are available depending on the variant ordered.

2.5.1 Surface-mounted Housing and Dongle Cable

Housing

The housing consists of a tube with a device-specific rear plate and a front panel without indication and control elements. Guiding mats are mounted inside the tubular housing on the top and the bottom. The modules are mounted on these mats. Each guiding mat has visible numbering from 1 to 42 to indicate the module slots. The modules are interconnected and connected with the front cover by means of ribbon cables with connectors. The rear panel screwed onto the tubular housing contains the terminal blocks required for the connections of the device.

There is a nameplate sticker on the housing with the most important device data, such as the auxiliary voltage, test voltages and order number (MLFB).

The housing is mounted at the top and bottom by means of a bracket with 3 holes for the housing size $1/2$ and 5 holes for the housing size $1/1$.

Dongle Cable

The 2.5 m dongle cable partially replaces the function of the detached operator control panel. The front operator interface of the device is brought out of the device via the 68-pin connector and made accessible at the dongle cable via a 9-pin D-subminiature female connector (see Figure 2-16 and 2-17). The device can be initialized and operated via this female connector.

Information on installing the 9-pin D-subminiature female connector with the supplied fixing parts in the switchgear panel or cubicle door can be found in the device manual, Chapter *Installation and Commissioning*.

Please refer to the *Technical Data* in the appendix of the device manual for information on the dimensions of the switchgear panel or cubicle door cutout.

2.5 Device Type Surface-mounted Housing without Operator Control Panel

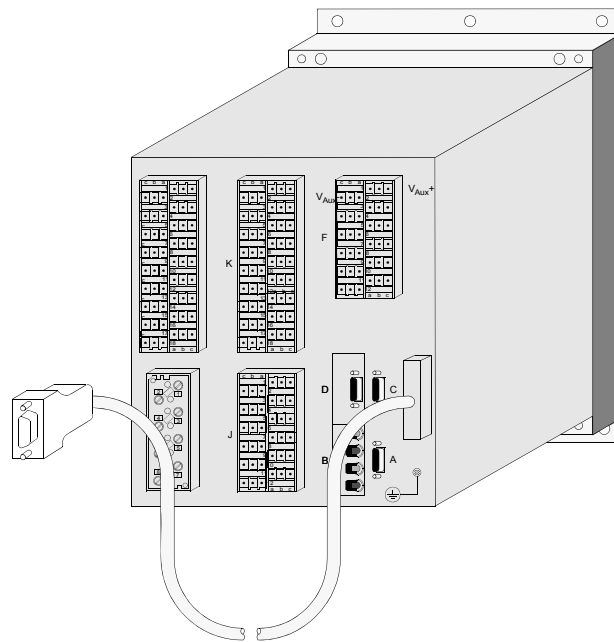

Fig. 2-16 SIPROTEC 4 device, housing size $1/2$ with dangle cable, example

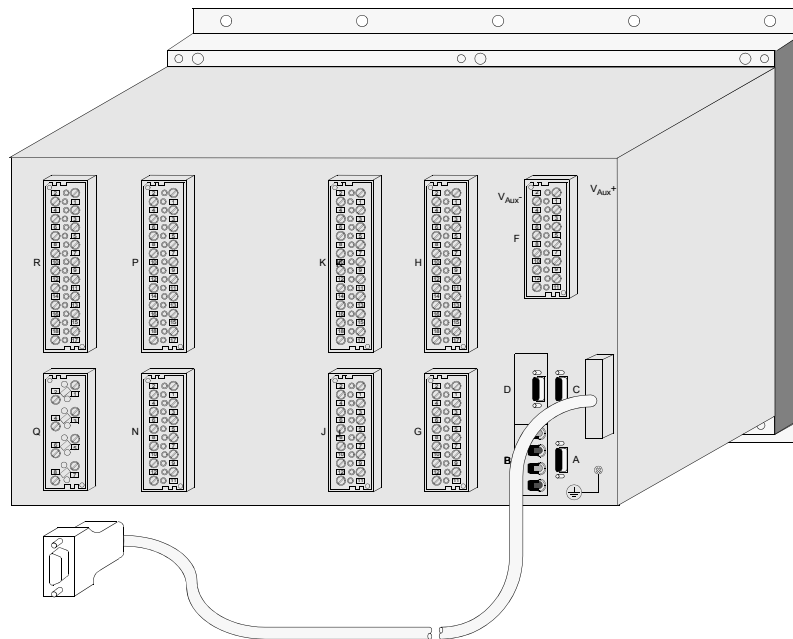

Fig. 2-17 SIPROTEC 4 device, housing size $1/1$ with dangle cable, example

2.6 Connections with Screw Terminals - Panel Flush Mounting

Connections with screw terminals are available in devices for

- Panel flush mounting and cubicle mounting and in
- Devices with detached operator control panel

The following types of screw terminal are used for the connections:

- Connection modules for **voltage connections** and
- Connection modules for **current connections**.

The terminal screws are slot-head screws to be tightened and loosened using a screwdriver. The head form of the terminal screws is designed for use with a simple flat 6 x 1 screwdriver.

2.6.1 Connection Modules for Voltage Connections

There are two variants of the connection modules for voltage connections:

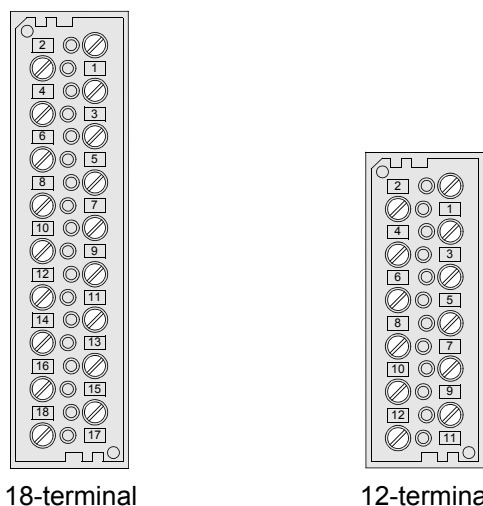

Fig. 2-18 Connection modules with screw terminals for voltage connections, rear view

The following figure shows an example of the assignment of an individual screw terminal to its terminal number.

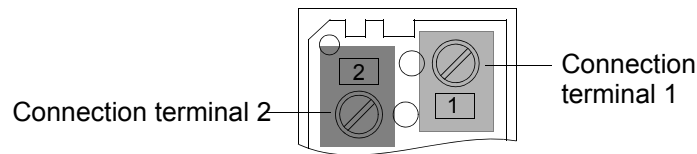

Fig. 2-19 Assignment of the screw terminal to its terminal number, example

Ring and spade lugs can be used for connection. To comply with the required insulating clearance, use insulated cable lugs only. Otherwise, insulate the crimping zone by appropriate means (e.g. by covering with a shrink-on sleeve).

The following data must be ensured:

Cable Lugs

Diameter for bolts 4 mm;

Maximum outer diameter 10 mm;

For cross-sections of 1.0 mm² to 2.6 mm², corresponding to AWG 16 to 14.

Only use copper conductors!

Cable lugs of series PIDG from Tyco Electronics AMP Co. are recommended, e.g.

Ring cable lug: PIDG PN 320565-0

Spade lug: PIDG PN 321233-0

Direct Cable Connection

Solid or stranded conductor with connector sleeve

For cross-sections of 0.5 mm² to 2.6 mm², corresponding to AWG 20 to 14.

The connection end of an individual cable must be plugged into the terminal chamber in such a way that it is drawn in as the terminal screw is tightened.

Only use copper conductors!

Stripping Length

For solid cables 9 mm to 10 mm.

Tightening Torque

Max. 1.8 Nm.

2.6.2 Connection Modules for Current Connections

There are two variants of the connection modules for current connections:

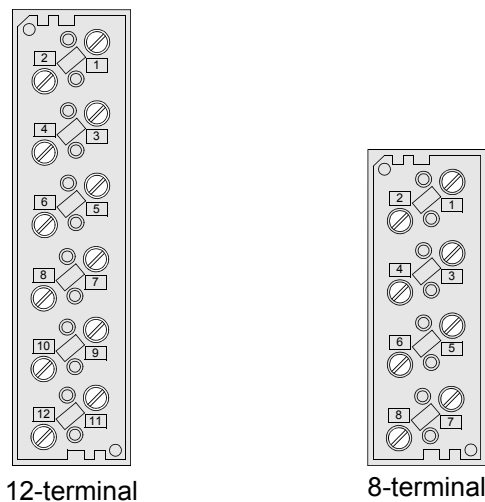

Fig. 2-20 Connection module with screw terminals for current connections, rear view

For terminals of the current connections, the same assignment of terminals to terminal numbers applies as is shown in Figure 2-19.

The available number of contacts is subdivided into 2-pole pairs. A pair is always formed from two adjacent contacts. The eight-pole current block therefore contains four pairs.

Together with the plug connector on the module end these pairs dispose of an integrated short-circuiter function which each short-circuit 2 neighboring conductive continuities when the module is withdrawn. Otherwise high voltages could occur at open secondary electric circuits which endanger the operating personnel and the converter isolation.

When the module is plugged in, the current path through the measurement inputs of the module is terminated with a low resistance.

The short circuit of the current path is automatically interrupted while the module is being plugged in. This interruption does not occur until safe contacting with the connector of the module side is guaranteed. This does not release you from your obligation to be careful when handling current transformer secondary circuits.

The short-circuiter of the current contacts is located in the terminal block of the housing side, the confirmation pin in the connector of the module side.

Ring and spade lugs can be used for connection. To comply with the required insulating clearance, use insulated cable lugs only. Otherwise, insulate the crimping zone by appropriate means (e.g. by covering with a shrink-on sleeve).

The following data must be ensured:

Cable Lugs

Diameter for bolts 5 mm;
Maximum outer diameter 12 mm;
For cross-sections of 2.6 mm² to 6.6 mm², corresponding to AWG 14 to 10.

Only use copper conductors!

Cable lugs of series PIDG from Tyco Electronics AMP Co.
are recommended, e.g.

Ring lug: PIDG PN 130171-0

Spade lug: PIDG PN 326865-0

Direct Cable Connection

Solid or stranded conductor with connector sleeve

For cross-sections of 2.6 mm² to 3.3 mm², corresponding to AWG 14 to 12.

The connection end of an individual cable must be plugged into the terminal chamber in such a way that it is drawn in as the terminal screw is tightened.

Only use copper conductors!

Stripping Length

For solid cables 10 mm to 11 mm.

Tightening Torque

Max. 2.7 Nm.

2.6.3 Short Circuit Links and Covering Caps

Short Circuit Links

It is possible to group together several terminal points to form a function unit. That is done using special links.

The short circuit links can connect two terminal points on the same side of the terminal block. By connecting further links, you can loop through to further neighboring terminal points. Make sure that the links are connected on alternate sides. You can connect two short circuit links, or one link and one lug, or one single conductor to each terminal point.

The links comply with requirements for protection against electric shock.

There are short circuit links for voltage and current connections (Figure 2-21).

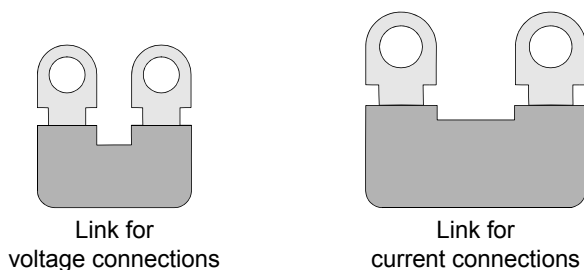

Fig. 2-21 Short circuit links for voltage and current connections

The order numbers of the short circuit links can be found in the Appendix of your device manual under Accessories.

Covering Caps

For terminal blocks with screw terminals, covering caps are available to increase the protection of personnel against hazardous voltages (degree of protection against access to dangerous parts) of the terminal module from the standard “back of the hand protection (IP1x)” to “finger protection (IP2x)”.

The covering caps enclose and safely cover all live parts. They are simply snapped onto the terminal block. Make sure that all screws of the block are screwed in first. The covering caps are simple to remove using a 6x1 mm screwdriver.

There are two types of covering caps (Figure 2-22):

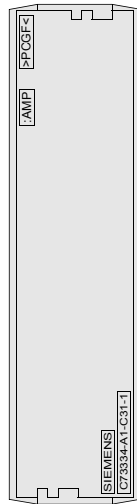

Covering cap for
18-terminal voltage module
and 12-terminal current module

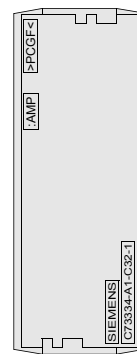

Covering cap for
12-terminal voltage
and 8-terminal current module

Fig. 2-22 Covering caps for connection modules

The order numbers of the covering caps can be found in the Appendix of your device manual under Accessories.

2.7 Connections with Screw Terminals - Panel Surface Mounting

Terminals

All the connections are taken to two-tier terminals which are located at the top and bottom at the surface-mounted housing.

The number of terminals depends on the housing size:

- Housing size $1/3$ has 60 terminals,
- Housing size $1/2$ has 100 terminals and
- Housing size $1/1$ has 200 terminals,

The connectors in the device for the current connections automatically short-circuit the current transformer circuits when the modules are withdrawn. This does not release you from the necessary care in handling current-converter secondary circuits.

Direct Cable Connection

Solid or stranded conductor with connector sleeve for conductor cross-sections of 0.5 mm^2 to 5 mm^2 , corresponding to AWG 20 to 10.

Use copper conductors only!

Stripping Length

For solid conductors 7 to 8 mm.

Tightening Torque

Max. 1.7 Nm.

2.8 Connections for Plug-in Terminals

Connections with plug-in terminals are available in devices for

- Panel flush mounting and cubicle mounting and in
- Devices with detached operator control panel

Connection modules with plug-in terminals are only available for **voltage connections**. The corresponding connection modules with screw terminals are installed for current connections.

Connection Modules

The connection modules are available in two variants:

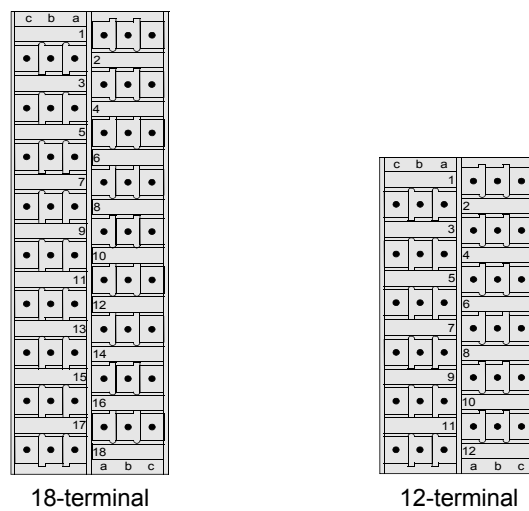

Fig. 2-23 Connection module for plug-in terminals

Figure 2-24 shows the assignment of the individual plug-in chambers to the connection number.

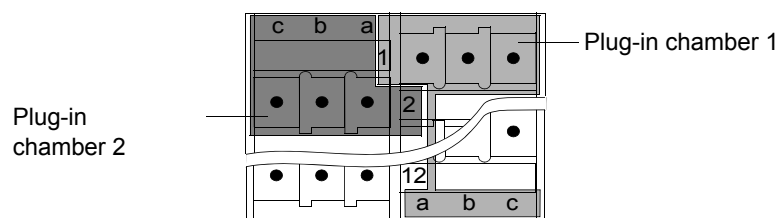

Fig. 2-24 Assignment of the plug-in chambers to the connection number, example

Contact Set

A complete set of contacts is available for each plug-in chamber. This set of contacts consists of three contacts with the following assignment:

- ❑ Terminal a: Signal contact
- ❑ Terminal b: Group contact
- ❑ Terminal c: Shield contact

The **signal contacts a** are the only contacts which have a direct connection to the plug connectors of the module end. Depending on the connection module variant, 18 or 12 signal contacts are available.

The **group contacts b** are only connected to each other and do not have any contact to the plug connectors of the module end. They are divided into two groups which have no connection to each other. Each group can be used, for example, for signal fan-out or as a signal interpolation point, irrespective of the neighboring signal contacts. Depending on the connection module variant, 18 or 12 common contacts are provided.

The group subdivision within the connection module is as follows:

- | | | |
|--------------------------------|---------|---------------------------|
| Connection module 12-terminal: | Group 1 | Plug-in chambers 1 to 6 |
| | Group 2 | Plug-in chambers 7 to 12 |
| Connection module 18-terminal: | Group 1 | Plug-in chambers 1 to 9 |
| | Group 2 | Plug-in chambers 10 to 18 |

The **shield contacts c** are connected to each other and lead on a large surface to the device rear. Depending on the connection module variant, 18 or 12 shield contacts are provided.

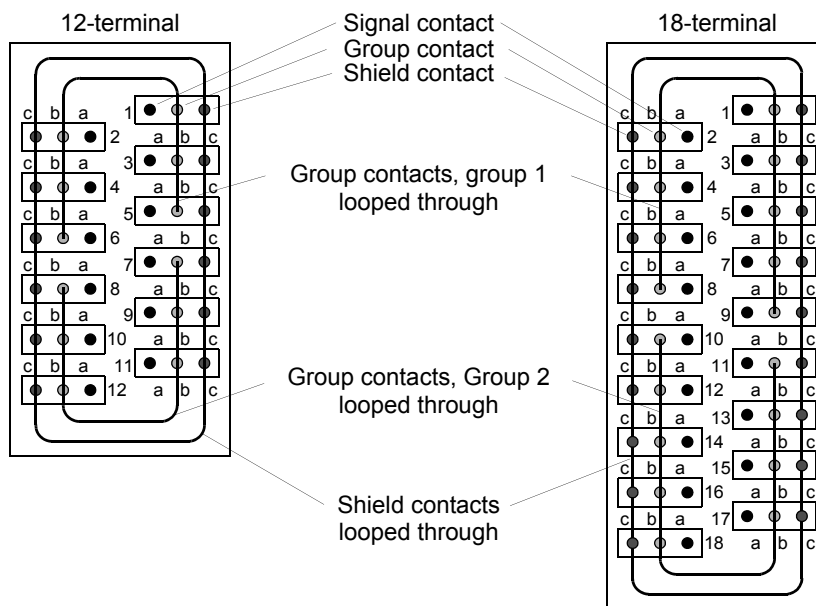

Fig. 2-25 Schematic representation of the connection modules

Termination System

On the housing end, socket housings are available for the connections of the pin contacts in the plug-in chambers.

There are 2 variants of the socket housings which differ only in the number of terminals.

Variant 1: 2-terminal

Variant 2: 3-terminal

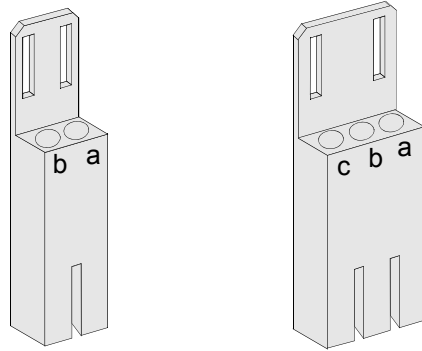

Fig. 2-26 Socket housing, 2- and 3-terminal

The order numbers for the socket housing are listed in the device manual appendix, Accessories section.

The socket housings are polarized to prevent incorrect plugging. It is thus ensured that only plugging into the terminals **a** and **b** is possible with Variant 1 (2-terminal). An erroneous attempt to plug into the terminals **b** and **c** is thus prevented by design.

The socket housings snap into the connection module when plugged in. They can be withdrawn without a tool.

The socket housings contain socket contacts to which the corresponding cables can be crimped. Use only stranded conductors!

You can crimp conductor cross-sections of 0.5 mm² to 2.5 mm², corresponding to AWG 20 to 14.

Use only stranded copper conductors!

The following socket contacts can be used:

Tinned model

Cross section 0.5 mm² to 1.0 mm²:

Tape of 4,000 pieces Type: 0-827039-1 of Tyco Electronics AMP

Single piece Type: 0-827396-1 of Tyco Electronics AMP

Cross section 1.0 mm² to 2.5 mm²:

Tape of 4,000 pieces Type: 0-827040-1 of Tyco Electronics AMP

Single piece Type: 0-827397-1 of Tyco Electronics AMP

The cables are crimped to the contacts using the following tools:

Crimping tool (example) Type: 0-734372-1 of Tyco Electronics AMP

Female die Type: 1-734387-1 of Tyco Electronics AMP

Gold-plated model (recommended)

Cross section 0.75 mm² to 1.5 mm²:

Tape of 4,000 pieces Type: 0-163083-7 of Tyco Electronics AMP

Single piece Type: 0-163084-2 of Tyco Electronics AMP

The cables are crimped to the contacts using the following tools:

Crimping tool Type: 0-539635-1 of Tyco Electronics AMP

Female die Type: 0-539668-2 of Tyco Electronics AMP

Siemens recommends using single pieces.

After you have crimped the wires, press the contacts into the chambers of the socket housing until they snap in.



NOTE

Use a cable binder to implement the strain relief of the conductors of each socket housing and of the complete cable sets!

Use the extracting tool Type 725840-1 of Tyco Electronics AMP to withdraw the contacts from the socket housings.

This extracting tool contains a tube which is subject to wear. It can be ordered separately. Type 725841-0 of Tyco Electronics AMP

2.9 Connections for Optical Fibers - Panel Flush Mounting

There are 3 variants of optical-fiber connections with ST connectors. They are provided with shrouding covers which prevent soiling and which can be removed by turning them 90° to the left.

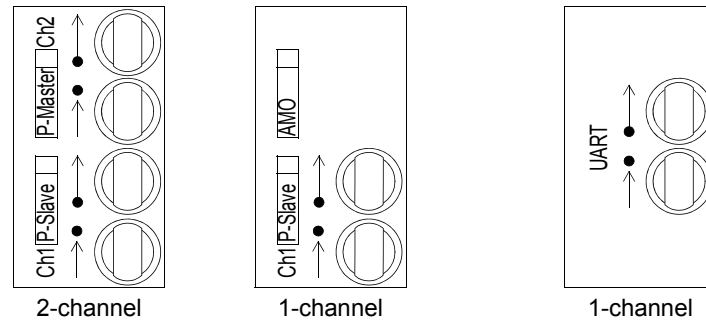

Fig. 2-27 Optical-fiber connections with shrouding covers

Termination System ST Connector

Optical-fiber connector type:	ST connector
Fiber type:	Multimode optical fiber G50/125 μm , G62.5/125 μm , G100/140 μm
Wavelength:	$\lambda = \text{approx. } 820 \text{ nm}$
Permissible bending radii:	For indoor cable: $r_{\text{min}} = 5 \text{ cm}$ For outdoor cable: $r_{\text{min}} = 20 \text{ cm}$

Class 1 according to EN 60825-1 is complied with when using fiber types: G50/125 μm and G62.5/125 μm .

2.10 Connections for Optical Fibers - Panel Surface Mounting

Connections

There are 1- to 4-channel variants at the optical-fiber connections. They are provided with cover caps to prevent the ingress of dirt. These caps can be removed by turning them 90° to the left.

A maximum of 2 optical-fiber channels each can be accommodated in each console housing. In the case of 1- and 2-channel layout the console housing for Channels B and/or C is positioned at the bottom of the device. The variant with up to a maximum of 4 channels on a second console housing for the Channels D and E at the top of the device (see Fig. 2-28). Console housings which are not used are replaced by cover panels. Unused optical-fiber connections are replaced by plastic plugs.

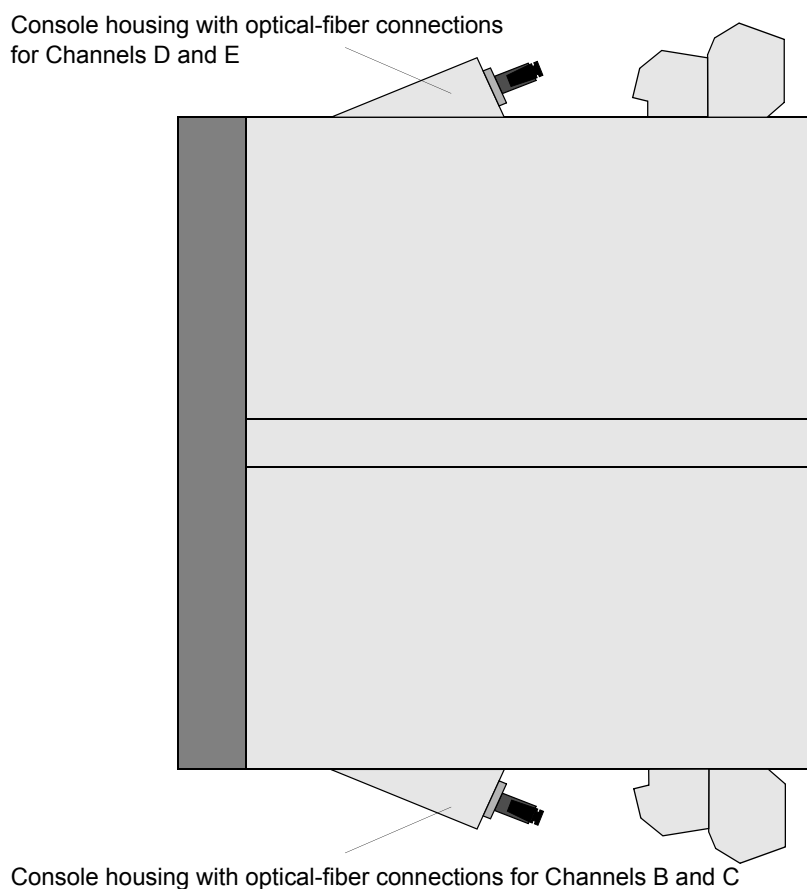

Fig. 2-28 Side view of a surface-mounted housing with optical-fiber connections (max. number of components)

The console housing has a table printed on it in which the used Channels B to E are marked. In Fig. 2-29 Channels B and C are used.

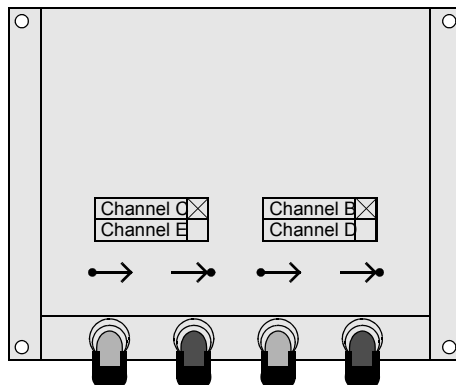

Fig. 2-29 Console housing with optical-fiber connections (example: Channels B and C used)

In the case of device variants with a PROFIBUS interface electrical RS485, there is no optical-fiber Channel B at the console housing at the bottom of the device. Instead there is a D-subminiature female connector for the PROFIBUS interface (see Fig. 2-30).

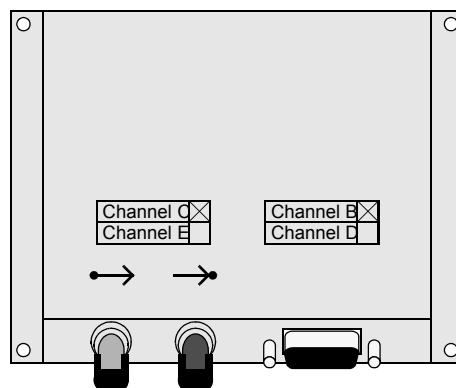

Fig. 2-30 Console housing with optical-fiber connection and D-subminiature female connector for the PROFIBUS interface

The following system interface protocols are always assigned in the surface-mounted housing to the D-subminiature female connector:

- PROFIBUS FMS
- PROFIBUS DP
- DNP 3.0 Level 2
- Modbus ASCII/RTU

The optical-fiber connection can be implemented here via an external electrical/optical conversion module.

Termination System ST Connector

Optical-fiber connector type:	ST connector
Fiber type:	Multimode optical fiber G50/125 μm , G62.5/125 μm , G100/140 μm
Wavelength:	$\lambda = \text{approx. } 820 \text{ nm}$
Permissible bending radii:	For indoor cable: $r_{\text{min}} = 5 \text{ cm}$ For outdoor cable: $r_{\text{min}} = 20 \text{ cm}$

Class 1 according to EN 60825-1 is complied with when using fiber types: G50/125 μm and G62.5/125 μm .

2.11 Connections for Electrical Serial Interfaces

Panel Flush Mounting

9-pin D-subminiature female connectors are used as connections (Fig. 2-31). The assignment of the D-subminiature female connectors is described in the device manual.

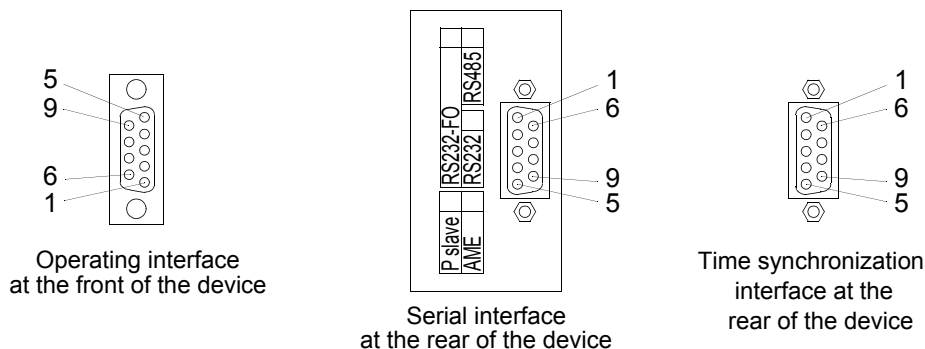

Fig. 2-31 9-pin D-subminiature female connectors

Panel Surface Mounting

9-pin D-subminiature female connectors, which are positioned in the console housings, are used for connection (Fig. 2-32). The assignment of the D-subminiature female connectors is described in the device manual under *Installation and Commissioning*.

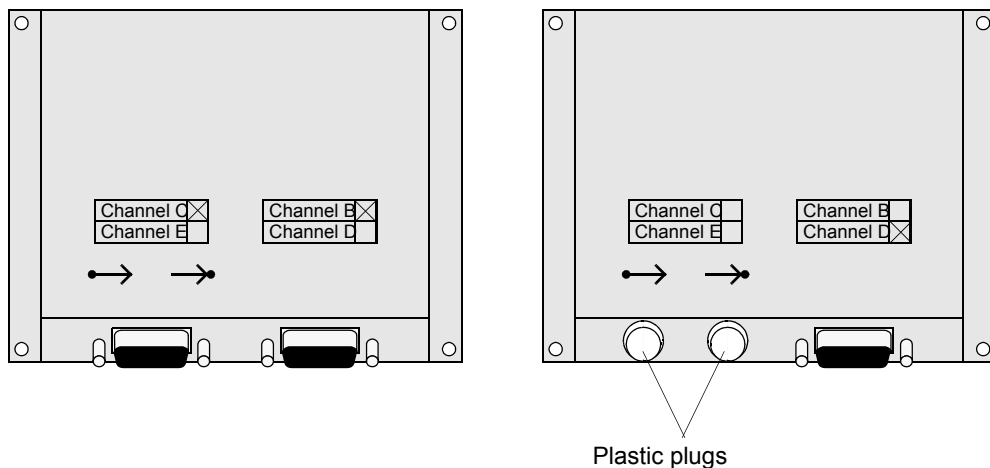

Fig. 2-32 Console housing with 9-pin D-subminiature female connectors

Termination System

As connectors you can use all commercial type 9-pin D-subminiature female connectors according to MIL-C-24308 and DIN 41652.

The connecting cables will depend on the type of interface:

- ❑ RS232: 3- or 5-core, shielded, e.g. interface cable 7XV5100-4.
- ❑ RS485: 3-core data cable, twisted and shielded.
- ❑ Profibus: 2-core or 4-core, twisted and shielded.
Cable type A according to DIN 19245 Part 2 and EN 50170 vol. 2, twisted and shielded,
Surge impedance: 135 Ω to 165 Ω ($f > 100$ kHz),
Capacitance per unit length: < 30 nF/km,
Loop impedance: < 110 Ω /km,
Core diameter: > 0.64 mm,
Core cross-section: > 0.34 mm²,
e.g., SINEC L2 industrial twisted pair installation wire
(see catalog IK 10 SIMATIC NET, Industrial communication networks)

2.12 Connections for Analog Output

2.12.1 Panel Flush Mounting

9-pin D-subminiature female connectors are used as connections (Fig. 2-33). The assignment of the D-subminiature female connectors is described in the device manual under *Installation and Commissioning*.

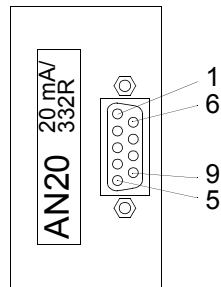

Fig. 2-33 9-pin DSUB socket

Termination System

For the connectors you can use all commercial type 9-pin D-subminiature female connectors according to MIL-C-24308 and DIN 41652.

- Connecting lead: 2-/4-core shielded
- Max. load 350 Ω

2.12.2 Panel Surface Mounting

9-pin D-subminiature female connectors, which are positioned in the console housings, are used as connections (Fig. 2-34). The assignment of the D-subminiature female connectors is described in the device manual under *Installation and Commissioning*.

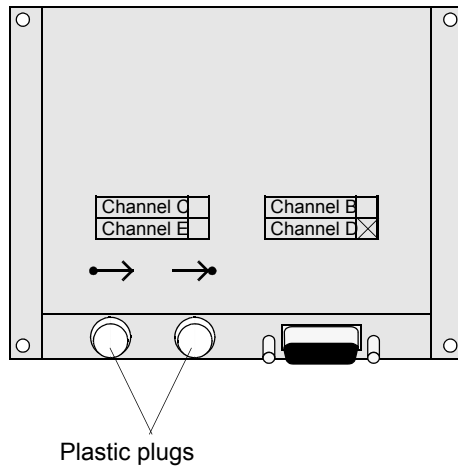

Fig. 2-34 Console housing with 9-pin D-subminiature female connector

Termination System

For the connectors you can use all commercial type 9-pin D-subminiature connectors according to MIL-C-24308 and DIN 41652.

- Connecting lead: 2-/4-core shielded
- Max. load 350 Ω

2.13 Connections for Low-level Signal Converter

The measurement quantities are connected via low-level plug connectors. Device sockets with colored coding disks which are accessible from the device rear are used to this purpose.

Three device sockets with blue coding disks are used for the voltage inputs and four with red coding disks for the current inputs.

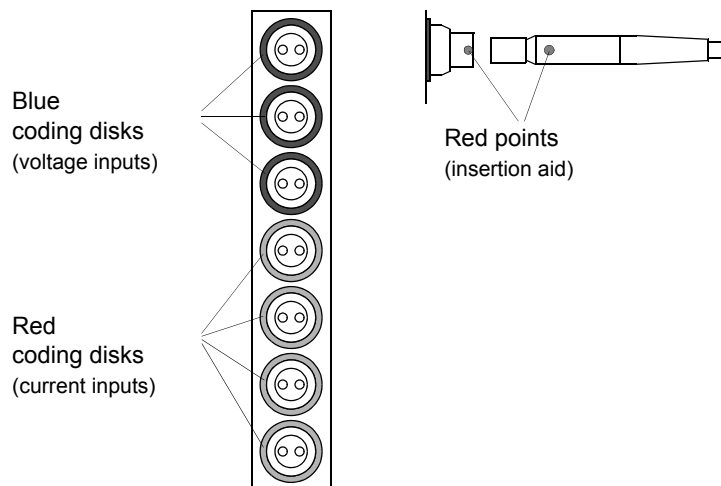

Fig. 2-35 Device sockets

When plugging in the cables coming from the converters ensure that the red marking of the connector is aligned with the red marking of the device socket (see Fig. 2-35), since they can only be connected in this position.

A space of at least 120 mm is required behind the device for this cable. For further information please refer to the *Technical Data* in the device manual.

■

Getting Started

This chapter describes the first steps which you should undertake upon receiving your SIPROTEC device.

In addition basic control operations via the operator interface of a SIPROTEC device are explained and the installation of DIGSI 4 is described.

Contents

3.1	Unpacking and Packing	72
3.2	Device Inspections upon Receipt	73
3.3	Operation Using the Operator Control Panel of the SIPROTEC 4 Device	61
3.4	Installing / Removing / Starting DIGSI 4	79
3.5	Storage	82

3.1 Unpacking and Packing

The SIPROTEC devices are packaged at the factory to meet the requirements of IEC 60255-21.

- Unpack the device with the usual care, without using force, and with appropriate tools.
- Visually inspect the devices immediately upon arrival for correct mechanical condition.
- Please also observe the brief reference booklet and all notes and hints enclosed in the packaging.



NOTE

The transport packing can be reused in the same manner for further shipment. The storage packaging of the individual devices alone is not sufficient for transportation. If alternative packaging is used, ensure that the transportation requirements according to IEC 60255-21-1 Class 2 and IEC 60255-21-2 Class 1 are fulfilled.

NOTICE

Before the device is connected for the first time to voltage, it should have been at least 2 hours in its operating room, in order to attain temperature equilibrium and to avoid dampness and condensation..

3.2 Device Inspections upon Receipt

3.2.1 Check of the Rated Data

Ordering Code

- Verify that the version has the required rated data and functions by checking the complete ordering code (MLFB) of the device. The complete ordering code of the device is printed on the nameplate attached to the top of the housing. The ordering key is described in the appendix of the device manual.
Observe in particular the assignment of the device ratings to the plant data. This data, such as the nominal auxiliary voltage and nominal current of the current transformers, is also listed on the rating plate.
- Check the accessories.



NOTE

Upon delivery the binary inputs are set so that a direct voltage to the value of the supply voltage is set as the control voltage.

3.2.2 Electrical Check



NOTE

Make sure that the operating conditions meet VDE0100 and VDE0105 Part 1.

NOTICE

Before the device is connected for the first time to voltage, it should have been at least 2 hours in its operating room, in order to attain temperature equilibrium and to avoid dampness and condensation.



WARNING

Some of the following check steps are performed partly in the presence of dangerous voltages. Only appropriately qualified personnel familiar with and adhering to safety requirements and precautionary measures may perform these steps..

For a first electrical inspection of the device it is sufficient to ensure safe grounding of the device and to connect the supply voltage. Proceed as follows:

- Connect the ground connection of the device to the protective grounding. The grounding screws are positioned on the rear of the device in the case of cubicle mounting and panel flush mounting. In the case of surface mounting a grounding terminal is used.
 - A supply voltage of correct level and polarity to the device inputs via a switch or an automatic circuit-breaker. Observe the block diagrams in the appendix of your device manual.
 - Switch on the switch or the automatic circuit-breaker for the supply voltage.
-
- ❑ The green "RUN" LED on the front panel must light up after no more than 0.5 s and the red "ERROR" LED must get off after no more than 10 s.
 - ❑ After no more than 15 s, the start-up indications, i.e. the complete ordering number, the version of the implemented firmware and the factory number, must disappear from the display.
 - ❑ The default display is output, the LEDs light up in accordance with the preset configuration of your device.

3.3 Using the Operator Control Panel of the SIPROTEC 4 Device

3.3.1 User Interface

The following sections briefly illustrate the navigation techniques in the display of the device by means of the operator control panel on the basis of typical operations. The illustrations of the examples show each menu completely. The devices can display only a limited number of lines at a time.

3.3.2 Navigating in the Operator Tree of the Display

The user interface of the SIPROTEC 4 device consists of a hierarchically structured operator tree through which you can move by means of the **paging keys** and the **MENU, ENTER, CTRL** and **ESC** keys.

- When the device is ready to operate, first press the **MENU** key in order to access the **MAIN MENU**.
- Then use the paging keys **Arrow down** or **Arrow up** in order to select a menu item and then move to the submenu by using the paging key **Arrow right**.
- Navigate by this method through the operator tree until you have reached the desired information.
- You can use the paging key **Arrow left** to move one level back.
- You can use the paging key **Arrow up** to move one menu item back.
- You can return to the **MAIN MENU** by pressing the **MENU** key once more or by pressing the **ESC** several times.

3.3.3 Reading out the Type Designation

In order to read out the complete type designation of the device, the version of the implemented firmware and the serial number:

- Select the menu item **Settings** and move further to the submenu **SETTINGS**.
- There select the menu item **Setup/Extras** and move further to the submenu **SETUP/ EXTRAS**.

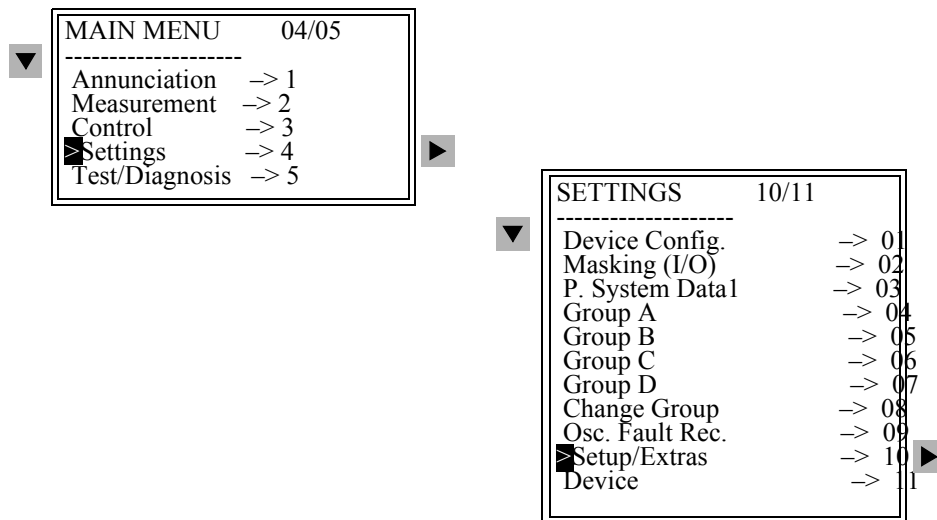

Fig. 3-1 SETTINGS submenu

- There select the menu item **MLFB/Version** and change to the menu **MLFB/VERSION**.

The device-specific data are displayed below each other in the display. Further characteristics are displayed by using the paging key.

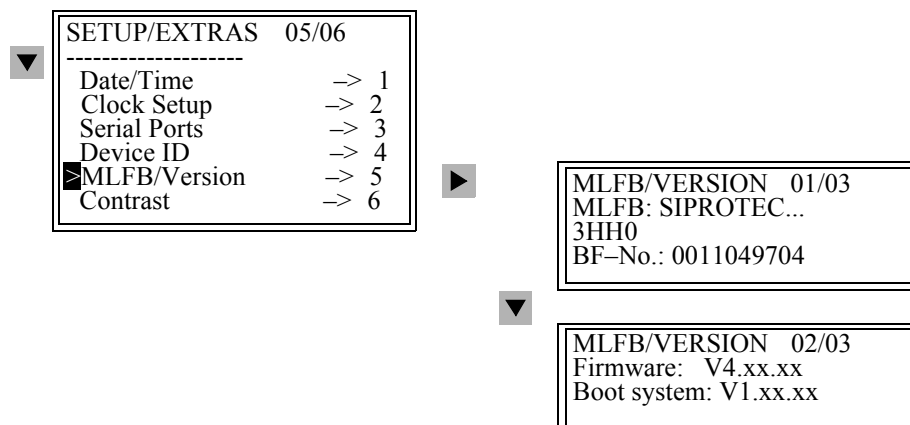

Fig. 3-2 Display of device-specific data — examples

3.3.4 Reading Out Operational Measured Values

In order to read out operational measured values:

- In the **MAIN MENU** select the menu item **Measurement** and change to the submenu **MEASUREMENTS**.
- Select, for example, the menu item **Operation. sec** (operational measured values secondary) and change to the menu **OPERATION. SEC**.
- Use the paging keys to read out all the operational measured values.

If there are no measurement quantities, all the operational measured values are indicated as near zero. Any deviations in the last position are insignificant.

3.3.5 Reading out Operational Indications

The reading out of operational indications is described briefly as a further example.

Proceed as follows:

- In the **MAIN MENU** select the menu item **Annunciation** and change to the submenu **ANNUNCIATION**.
- There select for example the menu item **Event Log** and change to the menu **EVENT LOG**.

The number in the upper right corner of the display indicates the number of operational indications in the memory. The number before the slash identifies the message which is being displayed. When the menu is entered, the most recent indication is displayed first. The date and time of the event are shown in the display line above the indication.

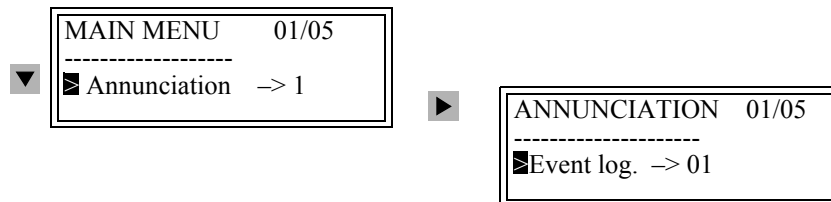

Fig. 3-3 Selection of indications on the device front - example

- Use the paging keys to read out all the operational indications.
- Press the LED push-to-test button.
All the light displays are illuminated, **LED acknowledgement** is displayed as the most recent indication and the number of indications has increased in the memory by one.

3.3.6 Setting the Display Contrast

The factory-preset contrast setting of the display in the integrated LC display can be modified by means of the operator control panel of the device. A stronger contrast is used e.g. to improve the readability of the image from an angle. **Only** change the preset value **in small steps** by one or two levels. If the contrast is too strong or too weak, the display may no longer be readable so that it may no longer be possible to operate the device.

Proceed as follows:

- Use the paging keys to select **MAIN MENU > SETTINGS > SETUP/EXTRAS > Contrast**
- Press the **ENTER** key. The current value of the setting appears in a text box, with a blinking text insertion cursor.
- Overwrite the previous setting by using the numerical keys. The higher the value, the stronger the contrast and thus the darker the image.
- Confirm your change with the **ENTER** key.

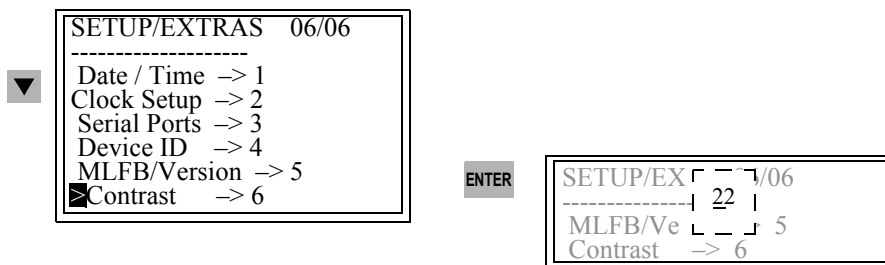

Fig. 3-4 Operating menu for setting the display contrast

3.4 Installing / Removing / Starting DIGSI 4



NOTE

Please read the information in the **Product_Information_DIGSI_V4_xx.pdf** file on the DIGSI 4 DVD before beginning with the installation.

If an older version of DIGSI 4 has already been installed, you must first remove this version (see Chapter 3.4.2).

From DIGSI V4.84 on, older versions are automatically uninstalled.

3.4.1 Installing DIGSI 4

Proceed as follows for installation:

- **Before carrying out the installation** please terminate all the applications in order to ensure that all the system variables relevant to DIGSI 4 are entered completely into the system directories.
- Insert the DVD into the DVD drive of the operating PC. The Setup menu is usually opened automatically.
- Click on the language to be used for the installation.
- Click on the **DIGSI 4.xx** command button.
- Follow the installation instructions.
- Enter the **serial number** which is listed on the supplied product card.
- Select one of the installation options:
 - **Complete** in case of first installation
 - **Custom** in order to install options packages or to re-install device drivers
- **Restart Windows before using DIGSI 4.**

Manual Starting of the Installation Routine

If the Setup menu does not open automatically, proceed as follows:

- Click on the Windows **Start** menu and select the entry **Run....**
- Enter **x:\Setup.exe** in the input box
(**x** stands for the drive character of the DVD drive).
- Click **OK**.
- Follow the further installation instructions (see above).



NOTE

If you use DIGSI 4 in a station control system and if you want to install SICAM plusTOOLS, proceed as follows:

- Remove DIGSI 4
- Install SICAM plusTOOLS
- Install DIGSI 4

If DIGSI 4 was not removed for any reason, you can re-install DIGSI 4 after the installation of SICAM plusTOOLS. However, we recommend the procedure described above.

Optional Products / Device Drivers

Components which can be used optionally can be installed at any time later. Proceed as follows:

- Insert the installation DVD and select the installation option **Custom** in order to install options packages or to install device drivers.
- Enter the **serial number** which is listed on the supplied product card.
- **Restart Windows before using DIGSI 4.**



NOTE

Please refer to the supplied product information for further information on the scope of delivery of DIGSI 4.

3.4.2 Removing DIGSI 4

Software products have to be removed in agreement with the Microsoft Windows procedure:

- Use **Start > Settings > Control Panel > Software** to open the **Software** window.
- Select **DIGSI V4.xy** and click on remove.
Repeat this action for further DIGSI components (e.g. **DIGSI 4 - SIPROTEC 4 Devices**).

Dynamically generated files may remain when a program is removed. This is recognized by the removal program and signaled with the message **Some elements could not be removed. You should manually remove items related to the application**. These dynamically generated files do not have to be deleted.



NOTE

Ensure that the computer is restarted after a program removal.



NOTE

Optional products cannot be removed separately.

3.4.3 Starting DIGSI 4

- In Windows select **Start > Siemens Energy > DIGSI 4 > Siemens DIGSI 4.xy**.
The DIGSI 4 Manager is started.

3.4.4 Working with DIGSI 4

The use of DIGSI 4 is described in the subsequent chapters. These contain information on

- Managing projects and devices (Chapter 4)
- Configuring systems and parameters (Chapter 5)
- Control operations (Chapter 6)
- Communication between the SIPROTEC device and DIGSI 4 or control systems (Chapter 7)



NOTE

The description *SIPROTEC DIGSI 4, Start Up /1/* provides a compact overview of the DIGSI 4 functions. Here a practical example is used to illustrate how to create a project, set device parameters, configure logic functions with CFC, edit display images, communicate online with the device and evaluate fault records

3.5 Storage

If the device is not used immediately, it can be stored under the following conditions:

- ❑ SIPROTEC devices and associated assemblies should be stored in a dry and clean place, with a maximum temperature range of -25 °C to $+55\text{ °C}$ (-12 °F to $+130\text{ °F}$).
For further information please refer to the *technical data* of your device manual.
- ❑ To avoid premature aging of the electrolyte capacitors in the power supply, a temperature range of $+10\text{ °C}$ to $+35\text{ °C}$ ($+50\text{ °F}$ to $+95\text{ °F}$) is recommended for storage.
- ❑ The relative humidity must not lead to condensation or ice buildup.
- ❑ The device must be in the final operating area for a minimum of two hours before the power source is first applied after storage. This time allows the device to attain temperature equilibrium, and dampness and condensation to be avoided.
- ❑ Before using the device connect it to the auxiliary voltage for 1 to 2 days. Under extreme climatic conditions (tropics), "preheating" is achieved at the same time, and condensation is prevented.
- ❑ After extended storage, the power supply of the device should be energized, approximately every two years, for one or two days to regenerate the electrolytic capacitors in the power supply.

■

Managing Projects and Devices

This chapter shows you how to organize your system file in projects, set up the devices and manage the device data. In addition you learn how to protect your data against unauthorized access by means of passwords and how to set the operating language of the devices in the device and in the PC.

Contents

4.1	General	84
4.2	Projects	86
4.3	Devices	110
4.4	Setting Values	125
4.5	Operating Language	131
4.6	Passwords	135
4.7	Exporting / Importing Data	141
4.8	Updating the SIPROTEC 4 Device Types	153
4.9	Creating and Using User-defined Device Texts	159
4.10	Printing	160

4.1 General

DIGSI 4 is used to set parameters and operate your SIPROTEC devices via a PC. The functionality is implemented program-specifically by the DIGSI 4 components sketched briefly below.

DIGSI 4 Manager

The DIGSI 4 Manager manages SIPROTEC devices including their data and communication connections.

If you use the SIMATIC STEP7 automation technique or use your SIPROTEC devices in the SICAM station control system, you can also use the device parameters configured with DIGSI 4 in these systems. Data exchange is carried out by means of a similar system interface since the data managers of the various systems manage the data of a plant in the form of projects. This provides a comfortable platform for information exchange from the device level to the control system.

DIGSI 4 Device Configuration

DIGSI 4 Gerätebearbeitung is used to configure a device by specifying the functional scope, configuring information, changing setting values and configuring the device interfaces.

After a connection has been established between the DIGSI 4 PC and the device, you can display process data, such as indications and measured values, carry out test functions and control devices.

In addition you can compare, save, export and print all the device parameters.

The configuration of the devices is described in Chapter 5. The operating conditions are described in Chapter 6.

DIGSI 4 Display Editor

The DIGSI 4 Display Editor is a tool for editing and managing the basic and the control display of the SIPROTEC 4 device using a graphical display.

The **basic display** provides information on the device, such as the protective information, measured values, position of the switching devices or general information. The **control display** allows the device information to be displayed graphically and devices to be controlled.

Devices are displayed by means of symbols which are predefined or created by you and which can display different switching states.

Context-specific dialog boxes are used to link the control display to the process data via the DIGSI 4 configuration matrix.

DIGSI 4 CFC

The **DIGSI 4 CFC** component offers a number of logic functions supplied by default and is used to implement user-specific functions, such as

- ❑ Extension of the enable conditions for a switching command (for example with the position of a further disconnector and the information "spring loaded")
- ❑ Display of a user-specific group indication on LED (individual indications linked by means of operators such as AND, OR, NOT)
- ❑ Display of a new dynamic symbol for a device in the display (different states determined by CFC logic)
- ❑ Change option of the settings group (for example, dropping off all phase currents below a limit)
- ❑ Flashing alarm LED if the switching authority is set to "LOCAL"
- ❑ Implementation of a protective function not offered in the device (for example "Reverse power protection" or "Efficiency monitoring")
- ❑ Sequential positive operation after activation of a function key at the device (for example automatic grounding)
- ❑ Step-by-step load shedding at power drop (determination of the suitable feeders by the CFC logic)

DIGSI 4 Remote

The **DIGSI 4 Remote** optional package is required if you want to communicate via a **modem line** between your computer and a SIPROTEC device.

SIGRA 4

The **SIGRA 4** component supports you in analyzing faults in your network. It preprocesses the information recorded during a fault graphically. From the measured values supplied it calculates further quantities such as impedances or r.m.s. values, which facilitate the evaluation of the fault record. The quantities can be selected freely in the diagrams of the **Time signals**, **Vector diagrams**, **Locus diagrams** and **Harmonics** views.

In addition you can add further fault records for fault evaluation, for example of the opposite end of a line and synchronize these.

SIGRA is also suitable for evaluating fault records of the devices of other manufacturers.



NOTE

Appendix A.1 provides general operating information on DIGSI 4.

4.2 Projects

The DIGSI 4 Manager can be used

- ❑ To create a project,
- ❑ To structure the project (definition of the plant topology),
- ❑ To insert objects into a project structure and structure them hierarchically,
- ❑ To edit project structures by duplicating, moving and deleting objects,
- ❑ Archive, reorganize or delete projects.

4.2.1 Project Structure

Project

DIGSI 4 allows you to map the hierarchic structure of your plant to the project organization. Each hierarchy level is represented by a folder which contains the elements of the hierarchic level and the respective subordinate folders.

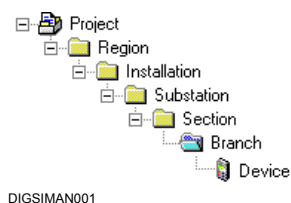

Fig. 4-1 Hierarchy within a project, example

Altogether, the required folders, devices and additional information comprise a project.

Object

Each element of a project structure is referred to an object.

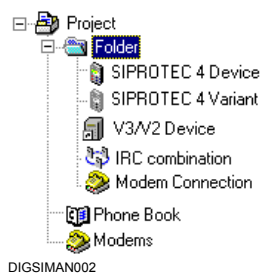

Fig. 4-2 Overview of the available objects, example

The availability of individual object types depends on certain prerequisites. For example, the objects **Phone Book**, **Modems** and **Modem Connection** are only available if the **DIGSI 4 Remote** program is installed.

Container

If an object can contain other objects, it is called a **container**.

**NOTE**

Ensure that the setting **<No filter>** is selected in the drop-down list box in the toolbar. Otherwise objects may possibly be hidden depending on the type.

4.2.2 Objects Within the Project Structure

Objects have properties, can be inserted at various points in the project hierarchy in accordance with specific rules and, depending on the object type, also have contents.

Objects are visualized by a specific icon and a name within the tree and list view of the DIGSI 4 Manager.

Object Types

In the tree view, up to four objects are initially automatically created within a new project.

Project

This object type is designated with the name of the new project. It cannot be inserted manually. It is inserted automatically at the highest point of the hierarchy and cannot be moved.

Folder

This object type is required to structure a project into different levels. You can structure a maximum of nine **folders** hierarchically under each other.

Phone Book

This object type is only created automatically if **DIGSI 4 Remote** is installed on your computer. It is required for communication between the computer and the SIPROTEC device via a modem connection and saves the addresses of the users of a modem connection.

Modems

This object type is only created automatically if **DIGSI 4 Remote** is installed on your computer. It is required for communication of computers and a SIPROTEC 4 device via a modem connection in order to save the modem profiles.

The following objects are only inserted manually in the objects of the "Folder" type:

SIPROTEC device

The **SIPROTEC device** object type represents a real SIPROTEC device with all of the relevant settings and process data.

SIPROTEC variant

The object type represents a variant of a real **SIPROTEC device**. The device data of this variant may well differ from the device data of the original object. Objects of type **SIPROTEC variant** have a variety of uses, such as documenting different operating states when entering parameter settings of a SIPROTEC device.

Modem connection

This object type can be created if **DIGSI 4 Remote** is installed on your computer. It is required for the communication between computers and a SIPROTEC device via a modem connection and contains information on the two partners of a modem connection to the local modem and to the remote comment.

The Modem connection object type cannot accept any further objects.

4.2.3 Creating a Project

All the required information is saved in the form of a project and displayed as objects in a hierarchical structure.

Proceed as follows:

- Select **File > New** in order to create a project.

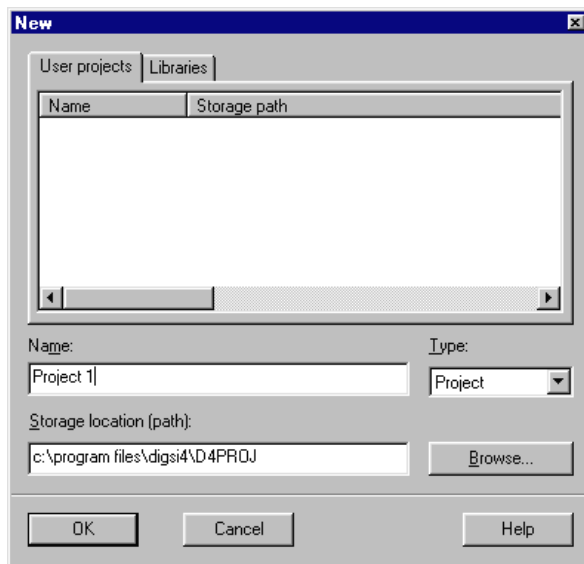

DIGSIMAN003

Fig. 4-3 New project

- Enter a name for the project in the **Name** input box.
- Specify a storage location for the new project.
A directory is suggested as the default setting in the **Storage location (path)** as the default setting (see Chapter 4.2.5).
If you do not want to use this path, enter a new path or select the directory by means of the **Browse** command button.
- Confirm by clicking **OK**.



NOTE

Further options, for example the creation of a library, are only relevant if a full version of STEP 7 is installed on your computer.

4.2.4 Editing Objects of a Project

Inserting an Object

Proceed as follows in order to insert the **Folder**, **Phone Book** and **Modems** objects manually:

- Click in your project hierarchy on the object of the level on which you want to insert a new folder and use the context menu to select the **Folder**, **Phone Book**, **Modems** or **Modem Connection**.
- Enter the name of the new project here.



NOTE

The **Phone Book** and **Modems** objects can only be inserted directly below the project. If an object of the type **Phone Book** or **Modems** already exists, it is deleted by the generation of a new object of the same type. All information contained in this object is lost! However, a confirmation query is displayed before a new object is inserted.

SIPROTEC devices are inserted into the project structure by **Drag&Drop** from the **device catalog** (see Chapter 4.3.1).

The **SIPROTEC variant** object type is created by:

- Creating a new variant of an existing **SIPROTEC device**
- Importing exported device data
- Establishing a connection to a SIPROTEC 4 device by plug-and-play

Opening Objects

Proceed as follows in order to open an object:

- Right-click the object name and select **Open Object** in the context menu
- or
- Select the object name and select **Edit > Open Object**.
- or
- Double-click on the object name.

Object Properties

Each object has properties. These can be general properties which are common to several objects or specific properties, for example the order number (MLFB).

Proceed as follows in order to display the object properties:

- Select the object, click in the context menu on **Object Properties** and open the **Properties - SIPROTEC Device** dialog box with its various tabs.

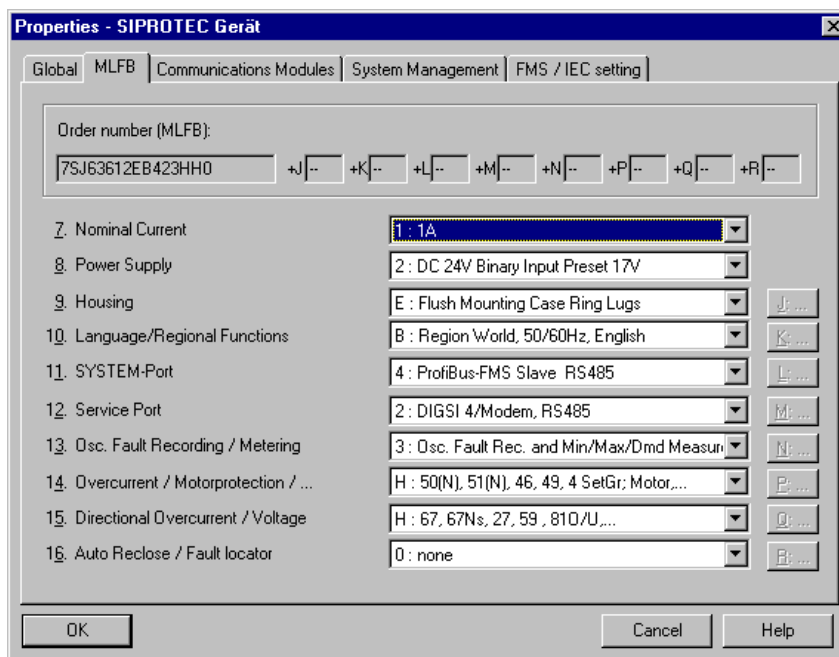

DIGSIMAN048

Fig. 4-4 Properties - SIPROTEC 4 device, MLFB tab, example

The values in the boxes with a white background can be edited or changed by using the drop-down list boxes. The boxes with a gray background display object properties which cannot change or cannot be changed directly. For example, the MLFB of a SIPROTEC 4 device can only be changed in off-line mode.

Editing the Project Structure

The editing commands **Copy**, **Cut**, **Paste** and **Delete** can be used to change the structure of a project. They are used to duplicate, move or delete objects.

An action on an object always acts on all the further objects contained in it. If, for example, you delete an object of the type **Folder**, all the other objects contained in it are also deleted.

Objects can be duplicated and moved across projects.

Copying Objects

Proceed as follows to copy an object:

- Select the object, click in the context menu on **Copy**, select the target object and click in the context menu on **Paste**.

or

- Select the object and click in the toolbar on the **Copy** icon. Select the target object and click in the toolbar on the **Paste** icon.

or

- Select the object, move it by **Drag & Drop**, with the left-hand mouse button pressed, to the target object and release the mouse button.

Moving Objects

Proceed as follows to move an object:

- Select the object, click in the context menu on **Cut**, select the target object and click in the context menu on **Paste**.

or

- Select the object and click in the toolbar on the **Cut** icon. Select the target object and click in the toolbar on the **Paste** icon.

or

- Select the object, move it by **Drag & Drop**, with the left-hand mouse button and the SHIFT key pressed, to the target object and release the mouse button.



NOTE

When a **SIPROTEC 4 device** is copied and moved

- The VD address is re-assigned automatically
- The IEC address is deleted. It has to be reset manually.

For information on the meaning on the VD address and IEC address please refer to Chapter 7.

Deleting Objects

Proceed as follows in order to delete an object:

- Select the object and click in the context menu on **Delete** and confirm the confirmation query with **Yes**.

4.2.5 Specifying and Changing the Storage Location for Projects

When a new project is created, DIGSI 4 suggests a path for the storage location of the project data. This presetting is changed as follows:

- Select **Options > Settings** and open the **Customize** dialog box. Enter the new path in the **General** tab (all the specified directories have to exist) or use the **Browse** command button to select the new directory.
- Confirm by clicking **OK**.

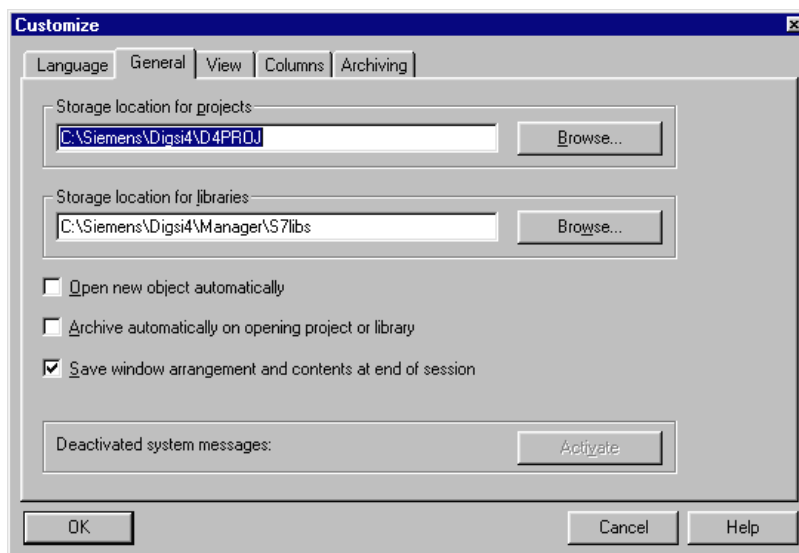

DIGSIMAN026

Fig. 4-5 Customize, General tab

4.2.6 Opening and Closing Projects

Opening at the Program Start

Proceed as follows if you want all the projects which were open on exiting the program during the last session to be opened automatically when DIGSI 4 is started:

- Select **Options > Settings** and select the option **Save window arrangement and contents at end of session** in the **Customize** dialog box, **General** tab.
- Confirm by clicking **OK**.

Opening the Last Edited Projects

The names and paths of the last four edited projects are entered automatically by DIGSI 4 in the **File** menu.

- Click the project which you want to open.

Opening Further Projects

Proceed as follows if you want to open a project which is not contained in the list of projects last opened:

- Click on **File > Open** and select the project in the **Open** dialog box, **User projects** tab.
- Select the names of all the projects which are to be opened. Confirm by clicking **OK**.

A separate window is opened for each selected project.

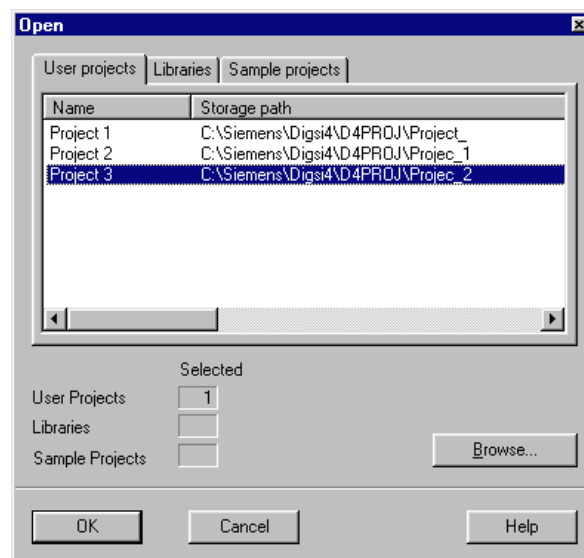

DIGSIMAN029

Fig. 4-6 Opening a project

- Click on the **Browse** command button if the project which you want to open is not contained in the list.

Closing a Project

- Click on any point in the project window in order to activate it and select **File > Close**. The project is closed.
- Select **Window > Close All** if you want to close all the opened projects.

4.2.7 Arranging Project Windows

The project window represents all objects of a project and their structural relationship.

- ❑ Project windows are created automatically when opening a project or manually via a menu command. The number of windows per project is not limited by DIGSI 4 Manager.
- ❑ The window position as well as the display within the window can be changed.
- ❑ You can open as many projects as you like, display them in different windows and arrange them in various ways.

Arranging Project Windows

For drag-and-drop operations it can be useful to arrange a project in two different windows.

Position the project windows on your screen by using **Arrange > Vertically** or **Arrange > Horizontally**. The windows are always arranged in such a way that they fill the desktop entirely.

Cascading is also possible. Minimized windows are ignored.

The window arrangement can be saved and restored after a change. A manually saved arrangement is overwritten by the presetting in the DIGSI 4 **Settings** dialog box.

Minimizing Project Windows

- In order to minimize all the opened project windows to icon size select **Window > Minimize All**. The individual icons are arranged along the lower edge of the desktop. If this arrangement was changed, you can restore it by clicking on **Window > Arrange Icons**.



NOTE

- Select **Window > New Window** in order to open a new window for the active project.
-

Project Window View

The **View** menu can be used to change the display mode for the data area of a project window. You have the choice between large and small icons or the list view with or without details. These functions are executed via the common Windows operations.

Proceed as follows in order to select the visible columns:

- Use **Options > Settings** to open the **Customize** dialog box. Select the **Columns** tab.

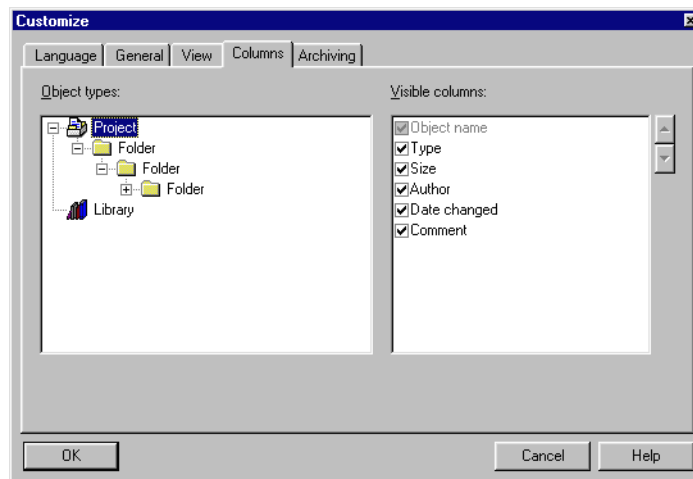

DIGSIMAN095

Fig. 4-7 Customize, Columns tab

- In the **Object Types** selection box select the object for whose level you want to influence the visibility and sequence of the columns. The object of the type **Library** is only relevant if you use the SIMATIC Manager.
- In the **Visible columns** box select the columns which are to be displayed by checking them in front of the column name.
- In order to change the column sequence select the name of a visible column. Move the selected name up or down by clicking on the arrow keys on the right-hand margin of the **Visible columns** box.
- Close the **Customize** dialog box with **OK**.
The project view is refreshed immediately in accordance with your settings.

Filtering by Object Types

With the help of filters you can suppress the display of certain object types. Such filters are created individually by you and are available for all projects.

- Select **View > Filter**.

If at least one filter has already been created, the **Filter** dialog box is displayed.

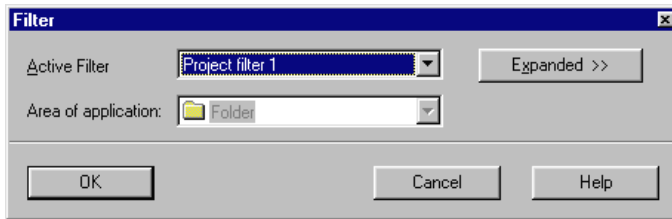

DIGSIMAN097

Fig. 4-8 Filtering (reduced)

- Click **Expanded** to open the **Filter** dialog box. If no filter has been created yet, this dialog box is opened directly.

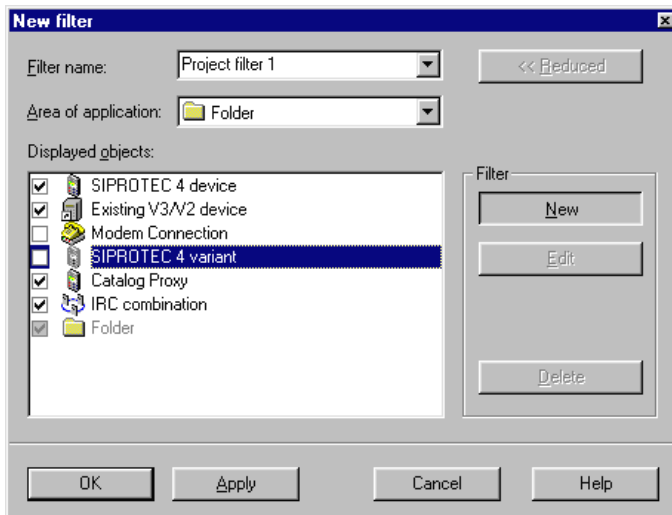

DIGSIMAN096

Fig. 4-9 Filtering (expanded)

Creating a Filter

- Click on the **New** command button in order to create a new filter. Enter a name for the new filter in the **Filter name** drop-down list box and select the area of application for the filter in the **Area of application** box.

The names of all the object types which the container selected in the "Area of application" box can contain are displayed in the **Displayed objects** box.

- In this field select the names of the object types which are to be displayed by checking the check-box before the object name. The **Project** and **Folder** containers cannot be hidden.
- Click **OK**.

Editing or Deleting a Filter

- In order to edit or delete an existing filter select the filter name from the **filter name** drop-down list box and click on **Edit** or on **Delete**.



NOTE

Filters are not created project-specifically but are available for all the projects. If you delete a filter, it is no longer available for any project!

Selecting a Filter

One filter each can be active for the **Project** area of application and the **Folder** area of application.

- Select the **Project** in order to activate a filter for the **Project** area of application.
- Select the **Folder** in order to activate a filter for the **Folders** area of application.
- Select a filter name from the drop-down list box in the toolbar.

Only the names of those filters are offered which were created for the selected area of application.

- Select **<No Filter>** if you want to view all the objects of an area of application.

4.2.8 Copying Projects

The configuration and parameter setting for your plant can be simplified and accelerated by the definition of sample projects. The DIGSI 4 offers a comfortable possibility of doing so.

You define the **sample project** and copy this data by simply changing the name and storage location of the project.

Proceed as follows:

- Select **File > Save As** and select the new path in the **Save project as** dialog box.

4.2.9 Deleting Projects

Projects are deleted by means of dialog boxes.

Proceed as follows:

- Use **File > Delete** to open the **Delete** dialog box and select the **User projects** tab.

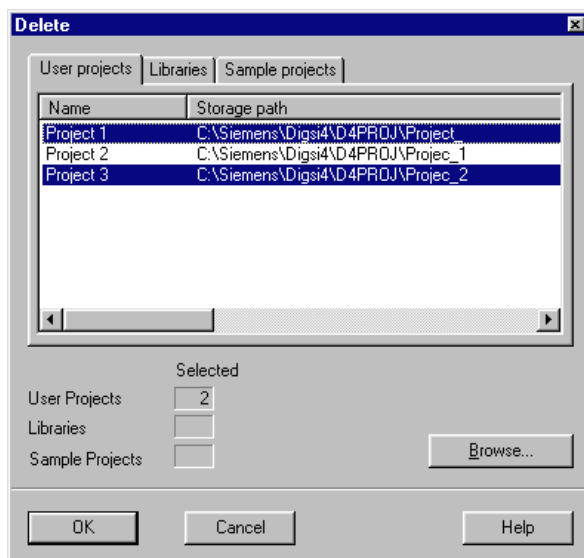

DIGSIMAN031

Fig. 4-10 Deleting Projects

All the projects which have been created and whose storage location is known to DIGSI 4 are displayed.

- Select the names of all the projects which are to be deleted and click **OK**. The number of selected projects is displayed in the **User projects** box.
- Respond to the global confirmation query with **Yes**. Also confirm the queries for each individual project with **Yes**.

Searching for Further Projects

- Click on the **Browse** command button if you want to delete a project which is not listed in the list of user projects.



NOTE

An opened project cannot be deleted.

4.2.10 Reorganizing Projects

Frequent addition and deletion of objects gives rise to memory areas that can no longer be used. By reorganizing projects, you can release these memory areas again.

Proceed as follows:

- Use **File > Reorganize** to open the **Reorganize** dialog box and select the **User projects** tab.

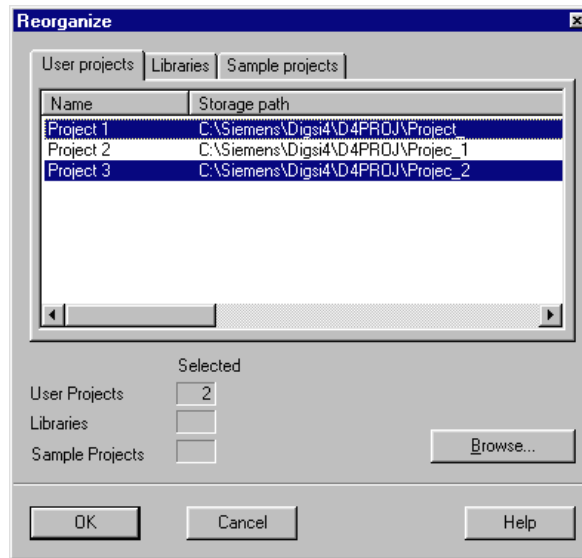

DIGSIMAN032

Fig. 4-11 Reorganizing projects

All the projects which have been created and whose storage location is known to DIGSI 4 are displayed.

- Select the names of all the projects which are to be reorganized one after the other and click **OK**.

An indication is displayed after a project has been reorganized.

- Click on the **Browse** command button if you want to reorganize a project which is not listed in the list of user projects.



NOTE

If you change the storage location of a project by means of **Save As**, you have a further possibility of reorganizing the project by using the option **With reorganization (slow)**. The save process then takes a little longer.

4.2.11 Managing Projects

If you work with a large number of projects, it can make sense to temporarily hide projects which you do not need for current processing from the project directories.

The DIGSI 4 Manager offers you the possibility of hiding projects and making them visible again when needed. The projects are neither moved nor deleted. Only the display of the project name in the dialog box for selecting projects is suppressed.

Proceed as follows:

- Use **File > Manage** to open the **Manage** dialog box and select the **User projects** tab.

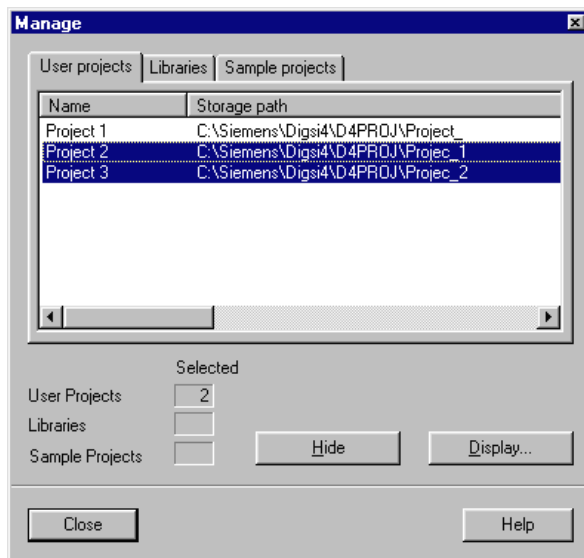

DIGSIMAN033

Fig. 4-12 Managing projects

All the projects which have been created and whose storage location is known to DIGSI 4 are displayed.

- Select the names of all the projects which are to be hidden and click **Hide**.

The number of selected projects is displayed in the **User projects** box.

Displaying Projects

- Click on **Display** when hidden projects are to be displayed again.

The **Browse** dialog box is opened.

- Select the names of the projects which are to be displayed and click **OK**.

4.2.12 Archive Settings for Projects

The DIGSI 4 Manager provides a comfortable archiving function for your projects. All the data belonging to a project is saved in compressed form in a file and extracted for further processing.

DIGSI 4 supports the archive programs ARJ, WINZIP, PKZIP, PKUNZIP and LHARC. The selection of one of these programs and the specifications of the required settings is carried out through dialog boxes.



NOTE

Please note that only data located within the project directories created by DIGSI 4 can be archived. These also include, for example, EXCEL files which are stored in the project directory. HV project description files assigned to a process control device are, for example, usually not stored within these directories and are therefore not archived. SIEMENS therefore recommends archiving the HV project description files separately.

Basic Settings

Before archiving a project for the first time carry out some basic settings.

- Use **Options > Settings** to open the **Customize** dialog box and click the **Archiving** tab.

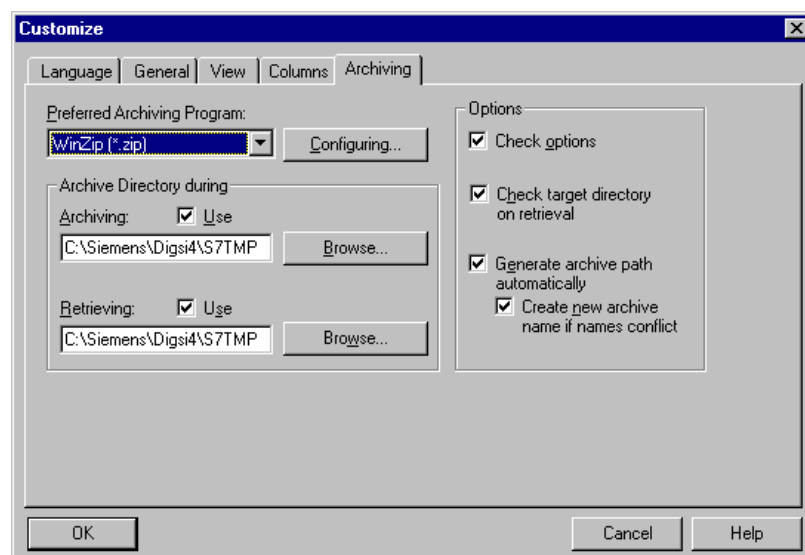

DIGSIMAN034

Fig. 4-13 Customize, Archiving tab

Selecting an Archive Program

- Check whether the desired archive program is installed. If necessary, install it.
- Select the archive program from the **Preferred Archiving Program** drop-down list box. All the supported programs are offered for selection, irrespective of which archive programs are actually installed on your computer.



NOTE

The WINZIP archive program can also be obtained via the Internet under www.winzip.com..

Configuring Archive Programs

- Click **Configuring**. The **Archiving - Configuring** dialog box is opened.

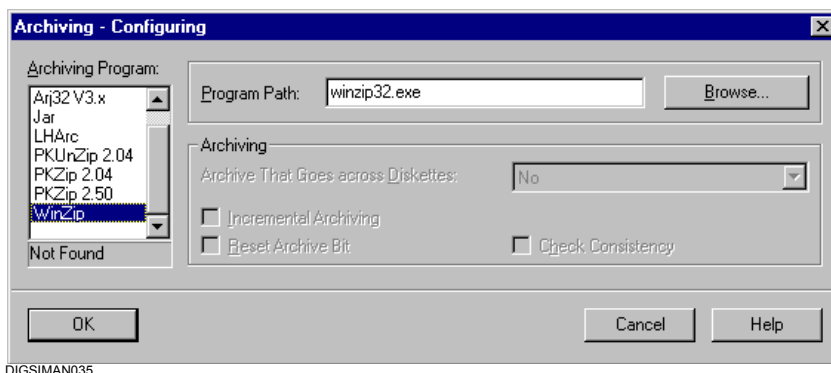

DIGSIMAN035

Fig. 4-14 Archiving - Configuring

Selecting an Archive Program

- Select the name of a program in the **Archiving Program** selection field. Depending on the selection various input and selection possibilities are active.
- Configure all the archive programs used by you consecutively. All the entries are saved separately for each archive program.

Specifying the Program Path

- Enter the path in which the archive program is installed in the **Program Path** box. The file name without drive and directory specifications is preset. This information is sufficient provided that the archive program lies within a directory which is specified in the search path. If this is not the case, the absolute program path has to be entered.
- Click **Browse** if you want to enter the directory path by means of dialog boxes.

If the archive program is not found in the specified path, the message **Not Found** is displayed below the **Archiving Program** selection box.

Creating an Archive That Goes across Diskettes

When archiving extensive projects on diskettes you may require several diskettes. In this case you create an archive that goes across diskettes.

- Select one of the following options in the **Archive That Goes across Diskettes** drop-down list box:
 - No**
This is the presetting. No archive that goes across diskettes is created, but only one single closed archive file.
 - Use Free Space**
If the diskettes already contain files, these are not deleted. The files of an archive are divided so that the free space on the diskettes is used optimally.
 - 1.4 MB, 1.2 MB, 720 KB or 360 KB**
The selection of one of these options sets the maximum size of an individual archive file. The files of an archive can be also saved on the hard drive in this form and later copied to the diskettes. These options are only available for the archive program **ARJ**.
 - Delete Files**
If the diskettes already contain files, these are deleted. This option is only available for the archive program **PKZIP**.

Specifying Archiving Options

- Incremental Archiving**
If this check mark is set, only such project files are archived whose ARC attribute is set. The ARC attribute, also referred to as archive bit, is set when a file is created and whenever it is edited or processed.
- Reset archive bit**
If this check box is activated, the archive bit of a file is reset after the file has been archived. The file is not included during the next incremental archiving if it has not been changed in the meantime. Not until the file has been edited or processed again is the archive bit set again automatically so that this file is included during further incremental archiving.
- Consistency check**
If this check box is activated, a comparison with the files to be archived is carried out while the archive file is being created. This achieves an additional protective measure against data corruption during the writing process, for example due to defective diskettes. This option is only available for the **ARJ** archive program.

Accepting Settings

- Confirm your settings by clicking on **OK**. The current dialog box is closed and you return to the **Customize** dialog box.

Carrying Out Further Settings

Now carry out further settings in the **Archiving** tab. Not every setting is used during archiving or retrieving depending on the archive program selected.

The following limitations apply:

- If you have selected **WINZIP** as the archive program, all the further settings in the **Archiving** tab are ignored.
- If you have selected **LHARC** as the archive program, the setting **Check Options** is ignored.

Specifying Archive Directories

- Specify a target directory for archiving and a source directory for retrieving. The directory specifications are used as the presettings for the dialog boxes during archiving or retrieving.
- Activate the respective **Use** check boxes. Otherwise the directory in which an archive file was last created is used as the directory presetting.

Options Settings

- De-activate the option **Generate archive path automatically** if you want to change the preset archive path during each archiving process and want to assign a name to the archive file.

If the option is activated, the name of the archive file is derived from the name of the project and the preset path or the path last selected is used as the archive path.

The option **Create new archive name if names conflict** is only available if the option **Generate archive path automatically** was selected. When the archive name is derived from the project name, a conflict can arise if an archive file of the same name already exists.

- Activate the **Create new archive...** check box so that the name of the new archive file is supplemented by a number in case of a conflict. This avoids that the existing archive file is overwritten.
If the option is de-activated, an existing archive file of the same name is overwritten after a confirmation query has been confirmed.
- Activate the option **Check target directory on retrieval** if you do not want to use the standard storage location for projects during retrieval. You are then prompted before every retrieval to specify a storage location.
- Activate the option **Check options** if you want to change the presettings immediately before archiving or retrieval.
- Accept all the settings with **OK**.

4.2.13 Archiving Projects

Archiving a project can be carried out via a menu command or carried out automatically when the project is opened.



NOTE

An opened project cannot be archived.

Archiving Via a Menu Command

- Use **File > Archive** to open the **Archiving** dialog box and select the **User projects** tab.

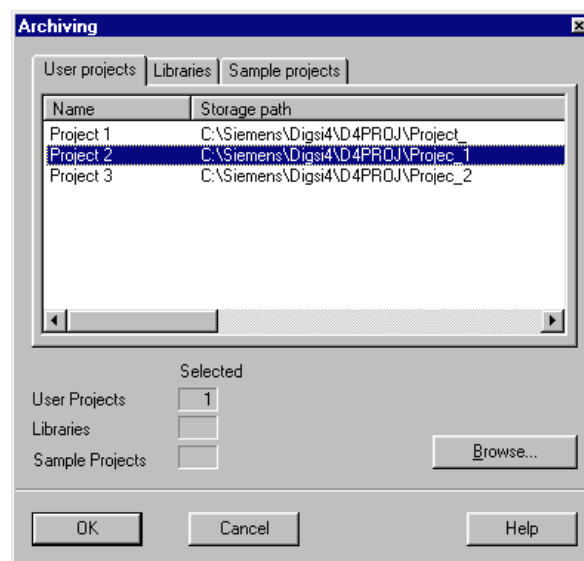

DIGSIMAN036

Fig. 4-15 Archiving

All projects whose storage location is known to the DIGSI 4 Manager are displayed.

- Select the names of all the projects which are to be archived and click **OK**.

The subsequent dialog boxes before the actual archiving depend on the settings (see Chapter 4.2.12).

- An indication is displayed if the specified archive program is not installed. Select an existing program and check the directory path.

Selecting Archives

- Use the **Archive - Select Archive** dialog box to select an archive for the project to be archived.

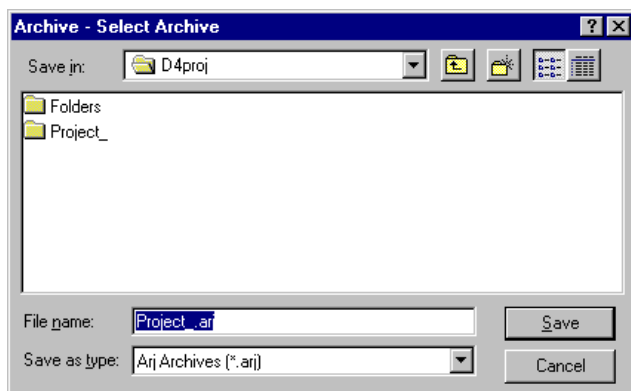

DIGSIMAN040

Fig. 4-16 Archiving - Select Archive

- Enter a name for the archive in the **File name** box. Take into consideration that the DOS conventions have to be observed for some archive programs, for example ARJ.
Or:
- Select an existing archive and click on **Save**.
- If you respond **Yes** to the confirmation query, the existing data is overwritten by the new data within the archive. **The existing data is irretrievably lost.**
- If you respond **No** to the confirmation query, the new data is attached to the existing data of the archive. This method allows the archiving of several projects within an archive.

The archiving process is logged. If you have selected several projects, they are archived consecutively.

Archiving Automatically prior to Opening

- Use **Options > Settings** to open the **Customize** dialog box.
- Activate in the **General** tab the check box **Archive Automatically on Opening a Project** and confirm with **OK**.

All the projects are then archived automatically before being opened.

4.2.14 Retrieving Projects

Proceed as follows in order to retrieve a project:

- Use **File > Retrieve** to open the **Retrieve - Select Archive** dialog box.

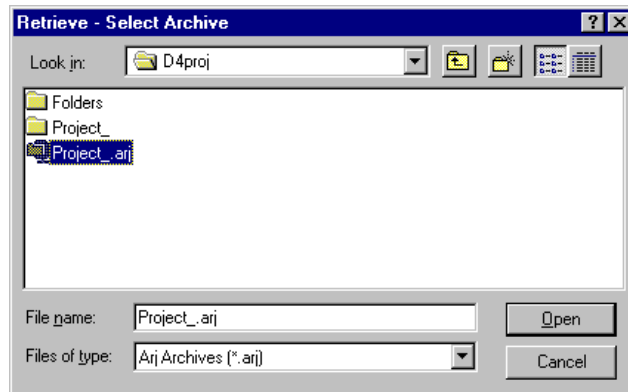

DIGSIMAN043

Fig. 4-17 Retrieving - Select Archive

- Select the archive which contains the project. To do so select the name of one of the archive files and confirm with **OK**.
You can only select one archive at a time for editing or processing.

The further course of retrieving depends on the archive settings specified.

- Select the target directory for the retrieved data and click **OK**.
- Select the retrieval options (see Chapter 4.2.12).

The retrieving process is logged.

4.2.15 Working under the SIMATIC Manager

If a full version of STEP 7 is installed on your computer, the SIMATIC Manager is used to create projects.

The SIMATIC Manager is extended by the DIGSI 4-specific functions by installing DIGSI 4.

Observe the following points when working with DIGSI 4 under the SIMATIC Manager:

- ❑ In the component view, all the SIPROTEC devices are assigned to an object of the type **Device container** which is only visible in connection with STEP 7. A device container only has **General properties**.
- ❑ All the functions of the DIGSI 4 Manager are accessible via the same menu commands in the SIMATIC Manager.
- ❑ The DIGSI 4 **Device** menu is called **PLC** in the SIMATIC Manager. It contains the two commands **Device > DIGSI (plug-and-play)** and **Initialize device**.

DIGSI 4 always shows the hierarchical structure of a project with all available objects. In addition to this **Topological View** the SIMATIC Manager also offers another project view, the **Component View**. The component view provides an overview of all the SIPROTEC devices within a project.

- Click **View > Component View** on the menu bar. Depending on the presetting the project view within the current project window is changed or a new project view is opened. The presetting can be modified via **Options > Settings** in the **View tab**.
- Click **Device** within the tree view. In the list view the designations of all the existing SIPROTEC 4 devices are shown.

The **Object Properties** provide information on the assignment of the device to the hierarchy level of the project.

- Use the context menu to select the **Object Properties** and change to the **System Management** tab.
The position of the device within the hierarchy is displayed in the **System Hierarchy** tab.
- Select **View > Topological View** in order to return to the hierarchical view of the project.

PROFIBUS

The Properties dialog box of a **SIPROTEC 4 device** has an additional **PROFIBUS FMS Connections** tab.



NOTE

Do not carry out any changes in this tab if you use the **PROFIBUS DP** protocol.

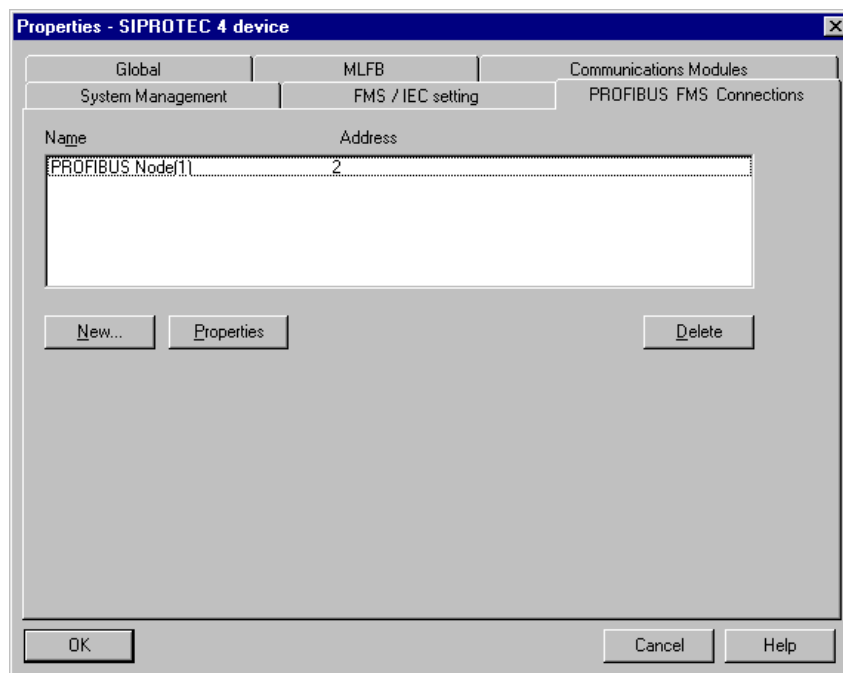

DIGSIMAN071

Fig. 4-18 Properties of SIPROTEC device, PROFIBUS FMS Connections tab

If a full version of STEP 7 is installed on your computer, set the PROFIBUS FMS address in the **PROFIBUS FMS Connections** tab. In this case you cannot make any entries in the **FMS / IEC setting** tab which you use in DIGSI 4 to set parameter values for the communication via IEC or PROFIBUS FMS.

The configuration of a PROFIBUS FMS communication connection is described in Chapter 7.

4.3 Devices

DIGSI 4 processes SIPROTEC devices V4, V3 and V2. The procedure of managing the devices within your project does not differ. The procedure is explained using a SIPROTEC 4 device as an example.

4.3.1 Inserting a SIPROTEC Device

Proceed as follows in order to insert a SIPROTEC device into your project:

- In your project structure select the level on which you want to insert the device (target directory) and use the **Insert New Object > SIPROTEC Device** or **Device Catalog** context menu to open the **Device Catalog** window.

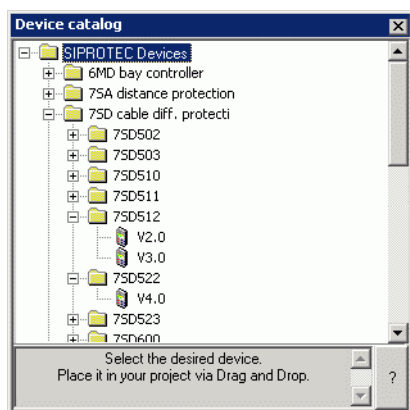

DIGSIMAN007

Fig. 4-19 Device catalog

- Open the directory of the device series to which your device belongs, for example **7SJ Overcurrent time protection**. Select your device within this directory, for example **7SJ631 V4.0** and drag-and-drop it into the target directory of your project.



NOTE

Please note that devices can only be inserted into **folders**, not directly into the highest project level. For this reason a **Folder** object is always created when a project is created.

4.3.2 Specifying the Device Model

The **Properties - SIPROTEC 4 Device** dialog box with the **MLFB** tab is opened before the device is inserted into the project structure

- Use the drop-down list boxes to select the parameters which correspond to the order number (MLFB) of your device model and confirm your selection with **OK**.

Properties - SIPROTEC Gerät

MLFB

Order number (MLFB):
7SJ63612EB423HH0 +J[-] +K[-] +L[-] +M[-] +N[-] +P[-] +Q[-] +R[-]

7. Nominal Current	1: 1A	
8. Power Supply	2: DC 24V Binary Input Preset 17V	
9. Housing	E: Flush Mounting Case Ring Lugs	J: ...
10. Language/Regional Functions	B: Region World, 50/60Hz, English	K: ...
11. SYSTEM-Port	4: Profibus-FMS Slave RS485	L: ...
12. Service Port	2: DIGSI 4/Modem, RS485	M: ...
13. Osc. Fault Recording / Metering	3: Osc. Fault Rec. and Min/Max/Dmd Measur	N: ...
14. Overcurrent / Motorprotection / ...	H: 50(N), 51(N), 46, 49, 4 SetGr; Motor,...	P: ...
15. Directional Overcurrent / Voltage	H: 67, 67Ns, 27, 59, 810/U,...	Q: ...
16. Auto Reclose / Fault locator	0: none	R: ...

OK Cancel Help

DIGSIMAN008

Fig. 4-20 Properties - SIPROTEC 4 device, MLFB tab

- In order to display the complete object properties of the SIPROTEC device, select the device in the data pane of the DIGSI 4 Manager and open the object properties via the context menu (also refer to Chapter 5.2).



NOTE

Information on the configuration of your SIPROTEC 4 device can be found in Chapter 5. The configuration of the communication connections is described in Chapter 7.

SIPROTEC V3 and V2 devices are configured similarly. For detailed information on the user interfaces please refer to the on-line help.

4.3.3 Offline / Online Operating Mode

There is **no connection to the device** in the **Offline** operating mode.

In the **Online** mode, there is a **communication link to the device** which can be realized in different ways.

The current operating mode of the device is displayed in the **status line** of the DIGSI 4 device processing.

Offline

In **Offline** mode

- You define the functional scope of a SIPROTEC 4 device,
- You make individual function settings,
- You configure information,
- You process the default display and control display using the optional program **DIGSI 4 Display Editor**,
- You define the settings for interfaces, time synchronization, and passwords,
- You create the logic functions with the optional program **DIGSI 4 CFC**,
- You display the stored measured values and indications,
- You set the limit values,
- You display stored fault records and evaluate these fault records with the optional program **SIGRA 4**,
- You export and print various data,
- You store all data processed in files.

Online

In **Online** mode

- You transfer parameter values from the computer to the SIPROTEC device,
- You transfer parameter values from the SIPROTEC device to the temporary memory of the PC and then save these in the permanent memory of the PC (see Chapter 4.4),
- You transfer indications, measured values and fault records from the SIPROTEC 4 device to the temporary memory of the PC and then save these in the permanent memory of the PC (see Chapter 4.4),
- You execute test functions,
- You control the equipment and set taggings,
- You initiate a restart or a resume of the SIPROTEC device,
- You set the date and time of the SIPROTEC device.

In addition you also dispose of the processing possibilities of the **Offline** operating mode. However, measured values, indications and fault records stored in the permanent memory of the PC can only be evaluated **offline**.

4.3.4 Opening the SIPROTEC 4 Device

Proceed as follows in order to open a SIPROTEC device:

- In the DIGSI 4 project view select the device and open the **Open Device** dialog box via the **Open Object** context menu.

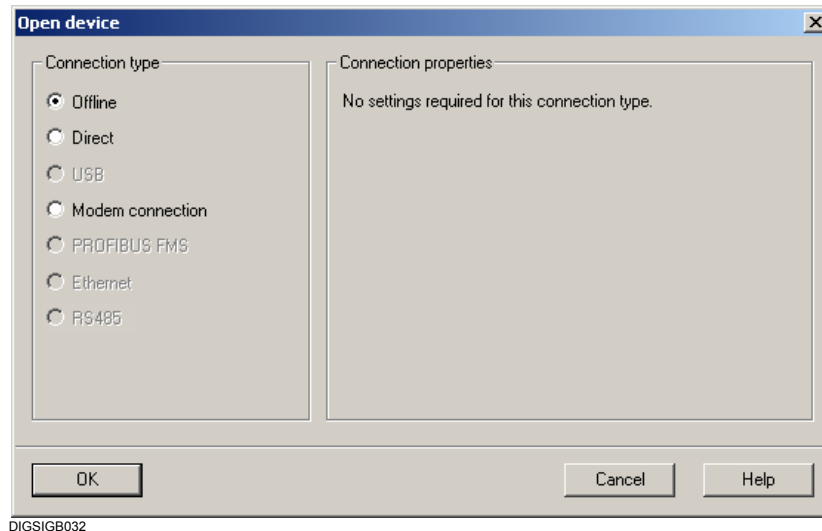

Fig. 4-21 Opening a device

Offline

- Select the **Offline** operating mode if you do not require a connection to the device. You then work with the data saved in the PC for the device.

Direct

- Select the **Direct** operating mode, the **PC interface** and the **Device interface** (and a **channel switch**, if required) if a connection is to be established to the SIPROTEC device via a serial interface of the computer.

USB

- Select this connection type to establish a connection from the computer's USB port to the USB port of the SIPROTEC 4 device (e.g. 7SJ80).

Modem Connection

- Select the **Modem connection** operating mode, the **modem connection** and **device interface** (and a **channel switch**, if required) if your device is connected to your PC via modem.

PROFIBUS FMS

- Select the **PROFIBUS FMS** operating mode if you want to communicate via a PROFIBUS FMS connection.

Ethernet

- Select the **Ethernet** operating mode if you want to communicate via an Ethernet connection.
- Confirm your selection by clicking on **OK**.

The progress of the connection establishing process is displayed.

If it is not possible to establish a connection, the **Establish Connection** display box displays a number of possible reasons.

- Check the physical connection between the computer and SIPROTEC device, eliminate the fault and click **Repeat**.
- If no valid parameter set is loaded in the SIPROTEC device, click **Initialize** and repeat the process of establishing the connection.

RS485

- Select the operating mode **RS485**, the **PC interface**, and the **device interface** (and a **channel switch**, if necessary) if a connection to the SIPROTEC device is to be established via an RS485 interface of the PC.



NOTE

If you want to use a device for which your PC does not yet have a valid parameter set, open the device via the **Plug-and-play** function (see Chapter 7.2).

Loading Settings

When the device is opened, all the parameter values of the SIPROTEC device which are stored in the PC are loaded.

In **Online** mode, the loaded parameters are then compared to the parameter values from the connected SIPROTEC device. You are prompted to decide which data you want to work with in case of inconsistencies. The stored data is not affected by your selection.

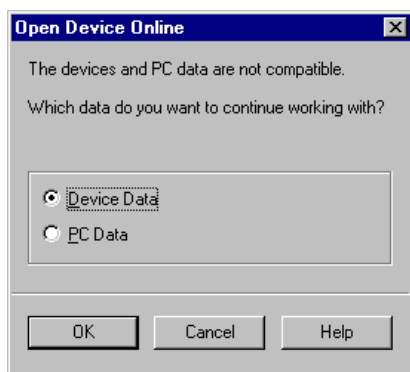

DIGSIGB018

Fig. 4-22 Data incompatibility between the device and the computer

- In the **Open Device Online** dialog box select **Device Data** or **PC Data**.

4.3.5 DIGSI Operating Tree

After all the data has been read in, the DIGSI 4 operating tree is built up and the device window is displayed.

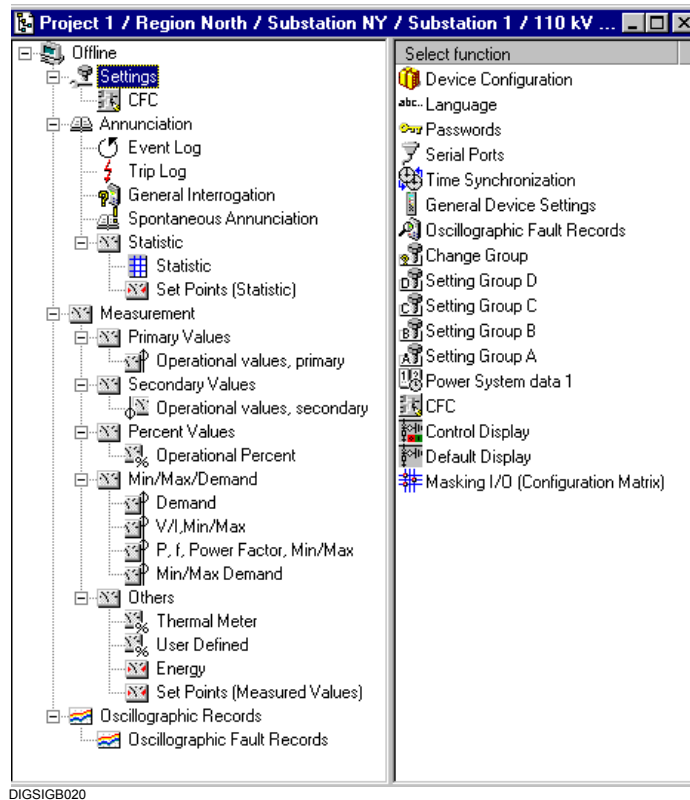

Fig. 4-23 Device window with operating tree in **offline** mode

Depending on the operating mode set, the device-specific processing functions are displayed in the navigation window. Some SIPROTEC 4 devices (e.g. 6MD63, 6MD66 and 6MD665) have no settings groups.

These objects can be used to carry out the following actions:

- Parameterizing
- Displaying process data
- Performing operator actions
- Executing test functions

Proceed as follows in order to select the individual functions:

- Click in the navigation pane (left-hand window) on the **function**, for example **Settings**.

The data pane (right-hand window) displays the subordinate **contents**, in the example **Select function**.

**NOTE**

The objects **Control** and **Test** are only available if you are working in **Online** mode.
The availability of individual objects in the function selection depends on the type of the SIPROTEC device and the set functional scope.

**NOTE**

The procedure for setting parameters is described in Chapter 5.
The control operations such as reading out indications, measured values and fault records, controlling devices, etc. are described in Chapter 6.
The test functions of the devices are explained in Chapter 8.

4.3.6 Triggering a Restart and a Resume

**NOTE**

If you execute the command **Restart** all device buffers, metered values and statistic values are reset (spontaneous indications remain unchanged). With a **Resume**, all device buffers remain unchanged. First save your settings and the buffer contents, if necessary, using the DIGSI 4 Device Editor before each Restart (see Chapter 6.2.7).

- Select **Device > Restart** or **Device > Resume** to trigger a restart or a resume.

Password Prompt

The triggering of a restart or resume can be protected by the **password for testing and diagnostics**. If this password is activated, it is prompted before one of the two commands is executed.

- Enter the correct passwords and confirm it with **OK**.

4.3.7 Setting the Time and Date in the SIPROTEC Device

DIGSI 4 allows you to set the date and time in the SIPROTEC device. You can enter the values in the dialog or as an alternative accept the system time and date of the computer.



NOTE

Do not use this option if the SIPROTEC device communicates with devices from the LSA equipment range.

- Select **Device > Set Time** and open the **Set clock & date in device** dialog box.

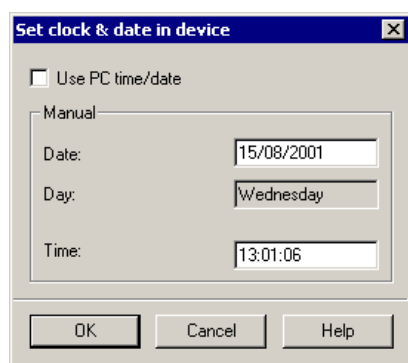

DIGISGB002

Fig. 4-24 Setting the date and time

- Enter the **date** and **time**. Make sure it is entered in the correct format, otherwise an error indication will be displayed.

or

- Select the **Use PC time/date** check box to accept the system date and system time of the computer. The input boxes are then deactivated.

The day is determined automatically from the date and cannot be changed.

- Confirm with **OK** in order to transfer your settings to the SIPROTEC device.

4.3.8 Changing the Operating Mode

DIGSI 4 allows you to switch operating modes without having to close and restart a SIPROTEC device. A prerequisite is that the device window is active.

Proceed as follows:

- Select **Device > Switch Online/Offline** in order to change from the **Offline** operating mode to the **Online** mode and, if necessary, save any unsaved changes.
- Select the connection time in the **Open Device** dialog box and confirm with **OK**.

The connection is established. Once connection is successfully established, the operating mode **ONLINE** is displayed in the status bar. The view of the device window is updated.

The process of changing from the **Online** operating mode to **Offline** mode is similar.

4.3.9 Cleaning Up the Data

Frequent addition and deletion of information that is configured to the system interface leaves memory areas behind that can no longer be used. Cleaning up the data frees up these memory areas again.



NOTE

As soon as you clean up the data, the information item numbers are reassigned. If the SIPROTEC 4 device is connected to a SICAM control center, you will have to perform a renewed data export to SICAM plusTOOLS!

Proceed as follows:

- Select **File > Clean Up** and confirm the confirmation query with **OK**.



NOTE

The cleaned up data is only finally accepted when you execute the **Save** command. If you have accidentally cleaned up the data, close DIGSI 4 Gerätebearbeitung without saving, and then restart it. However, you will then lose other changes that you have not yet saved.

4.3.10 Reading Out the Error Log

If faults occur in the SIPROTEC device, for example hardware defects or a destroyed parameter set, indications are stored in the error log of the device. In this case fault-free communication with the device is no longer ensured. Your attention is therefore drawn to existing faults during the attempt to establish a connection to the device. You can then read out the fault buffer in the SIPROTEC device and save the indications in a text file. Please then send this file to the DIGSI hotline.

If fault-free communication with the SIPROTEC device is not possible, the following indication is first displayed:

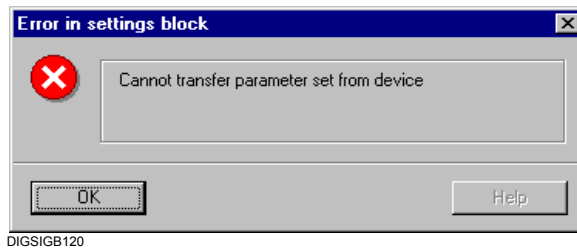

Fig. 4-25 Error in the parameter set

- Click **OK** and confirm the subsequent query with **Yes** in order to read out the error log.
- Enter the name and storage location of the fault file in the **Save As** dialog box. The **.txt** extension is preset as file type.
- Click **OK**. The text editor on your computer linked to **.txt** is opened automatically and the error log is displayed.
- Please send the error file to the DIGSI hotline.

```

Errorbuf.txt - Notepad
File Edit Search Help
MLFB:      7SJ62112EA401FE3-----
BFNr:     9805049375
FW:       U04.10.08
Adresse:   1

TextNr:    1
Laenge:   13
Fid:      17
Result:   64
Reason:   109

7SJ62112EA401FE3-----U4.10
U4.10
9805049375

Task Modul Reaktion Ort Info0 Info1 Datum/Zeit
0031 0031 0065 0000 00008800a2 00042b042c 13.10.99 09:05:2411
0031 0031 0030 0017 0000000000 0000000000 13.10.99 09:05:2414
0001 0014 0030 0001 0000000000 0000000000 13.10.99 09:05:2417
0031 0031 0065 0000 00008800a2 00042b042c 13.10.99 09:05:2420
0031 0031 0065 0000 00008800a2 00042b042c 13.10.99 09:05:2423
0031 0031 0065 0000 0000bc01c8 0000060000 13.10.99 09:05:2430
0031 0031 0065 0000 00008e0739 0000030401 13.10.99 09:05:2433
0031 0031 0065 0000 00008e0737 0000000000 13.10.99 09:05:2436
0031 0031 0065 0000 00008e0739 0000030401 13.10.99 09:05:2439
0031 0031 0065 0000 00008e0737 0000000000 13.10.99 09:05:2443
0031 0031 0065 0000 00008e0739 0000030401 13.10.99 09:05:2446

```

DIGSIGB121

Fig. 4-26 Text editor with error file, example

4.3.11 Closing the SIPROTEC Device

Individual Devices

If you want to close the processing of an individual SIPROTEC device, proceed as follows:

- Select **File > Close** and confirm the confirmation query in order to save the parameter set.

This closes the device window. If several device windows are opened, the window which has the focus on it is closed. DIGSI 4 Gerätebearbeitung remains open.

All Devices

If you want to close the processing of all opened devices, proceed as follows:

- Select **File > Exit** and confirm the confirmation queries of the individual devices with **Yes** if you have not yet saved the changes at the parameter set.

DIGSI 4 Gerätebearbeitung and all the opened devices are closed.

4.3.12 Copying Devices

You can define **sample devices** if you use a standardized parameter configuration, which for example orientates itself to company-internal specifications and provides for similar parameter configurations for devices of the same type. The sample devices can be duplicated as often as required by simple **copying**. A new device is created every time. Its settings can then be adapted at the individual location of this device.

Proceed as follows:

- Select the device in the data pane of the DIGSI 4 Manager and select **Copy** via the context menu. Click on the insertion location within the project hierarchy and select **Paste** via the context menu.

The created device contains the parameter settings of the original device but has a **different VD address**. It has to be re-initialized subsequently.

Creating Variants

If you do not want to copy devices but rather document **different operating states** during the parameter configuration of a device, you can use the DIGSI 4 Manager to create an operating state for each **SIPROTEC variant**.

The data of the device variant can be edited with DIGSI 4 just like the data of the original device.

Proceed as follows in order to create a device variant:

- In the data pane of the DIGSI 4 Manager select a **SIPROTEC device** and use **Create Variant** in the context menu to create an object which has the same name as the original object with the extension **.var**. It is displayed within the project structure on the same hierarchy level as the selected device.

The data of the created object is an image of the data of the original object, the **VD address** is also **identical**. The variant thus represents the same physical SIPROTEC 4 device.



NOTE

The following limitations apply when using **SIPROTEC 4 variants**:

- Coupling between a SICAM control center and SIPROTEC variants via SICAM plusTOOLS is not possible.
- A SIPROTEC 4 variant object cannot be a user of an IRC combination.
- A process bus link cannot be implemented.

4.3.13 Editing Data of V3/V2 Devices

There are no differences between SIPROTEC 4 devices and the device version V2.x or V3.x in the management of the device data by the DIGSI 4 Manager. You can insert devices, create variants, copy data, etc.

Parameter configuration in DIGSI 4 is carried out similarly to that of SIPROTEC 4 devices. Information on the user interfaces and the individual parameters can be obtained in the online help.

4.3.14 Inserting Existing V3 Systems

DIGSI 4 offers a convenient option to insert existing V3 systems into a DIGSI 4 project. The structure of the original project is applied automatically in this case.

To insert an existing V3 system in a DIGSI 4 project, proceed as follows:

- Select **Insert > DIGSI > Existing V3 system**. You reach the **Insert existing V3 system** dialog box.

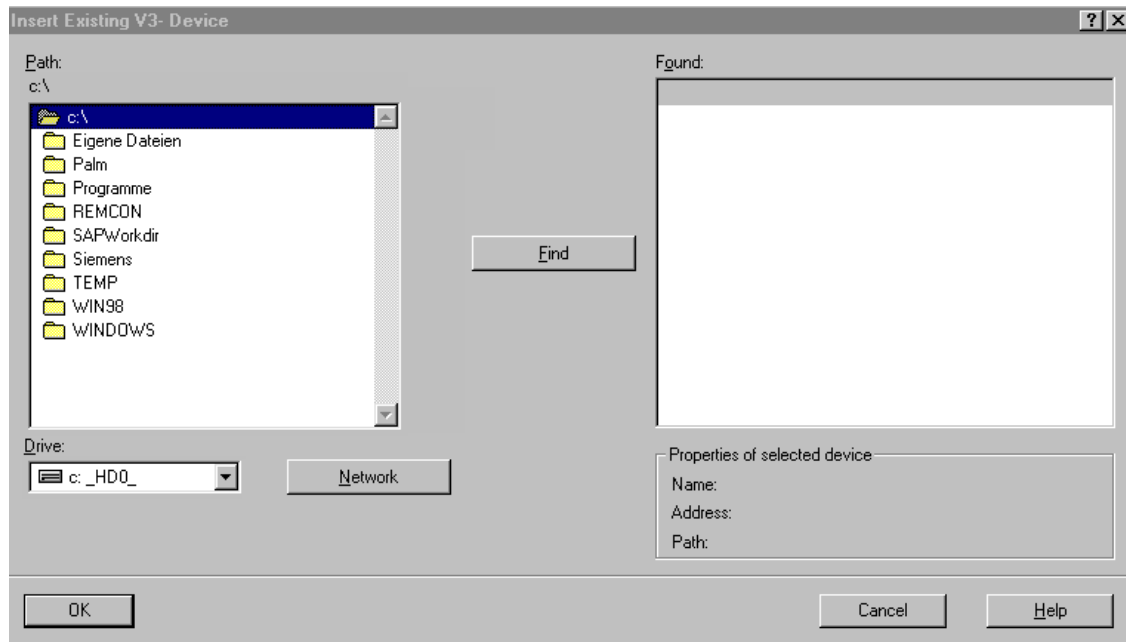

DIGSIGB156.GIF

Fig. 4-27 Inserting existing V3 systems (example)

- Select the directory which contains the desired V3 system in the **Path** area.
- Click **Find**: All V3 systems in the selected directory are displayed in the **Found** box.

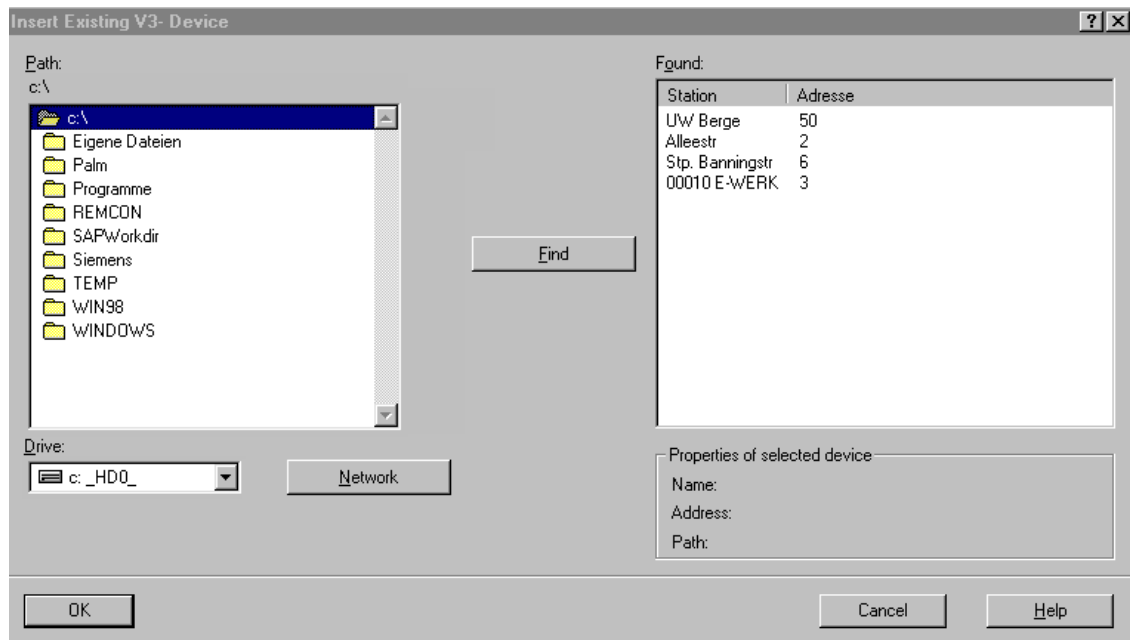

DIGSIGB156a.GIF

Fig. 4-28 Found V3 systems (example)

- If you click one of the found systems, its properties are displayed in the **Properties of the selected system** area.
- To accept one (or several) system(s) in your V4 project, select the system(s) in the **Found** box and click **OK**.

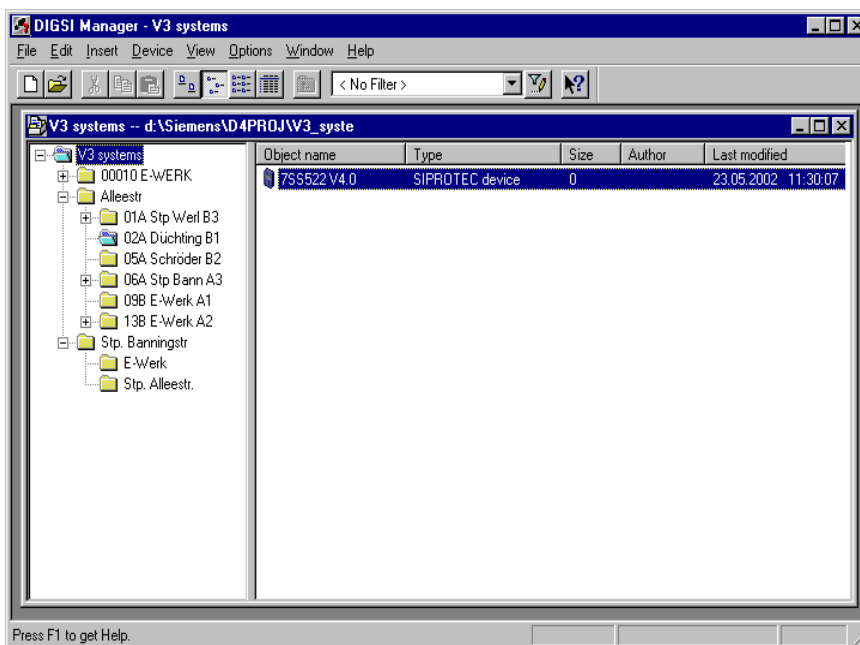

DIGSIGB157.GIF

Fig. 4-29 Inserted V3 systems in DIGSI Manager

The structure of the system is retained when inserting: A folder with the system name is created for each system. This folder contains a folder for each branch, with the corresponding name, which contains the devices. Each system folder is defined as an IEC address area, which prevents address conflicts between inserted systems.

4.4 Setting Values

Since you can work with your device in **Offline** mode or in **Online** mode, the following setting values may differ:

- ❑ In the temporary memory of the computer,
- ❑ In the permanent memory of the computer and
- ❑ In the permanent memory of the SIPROTEC device.

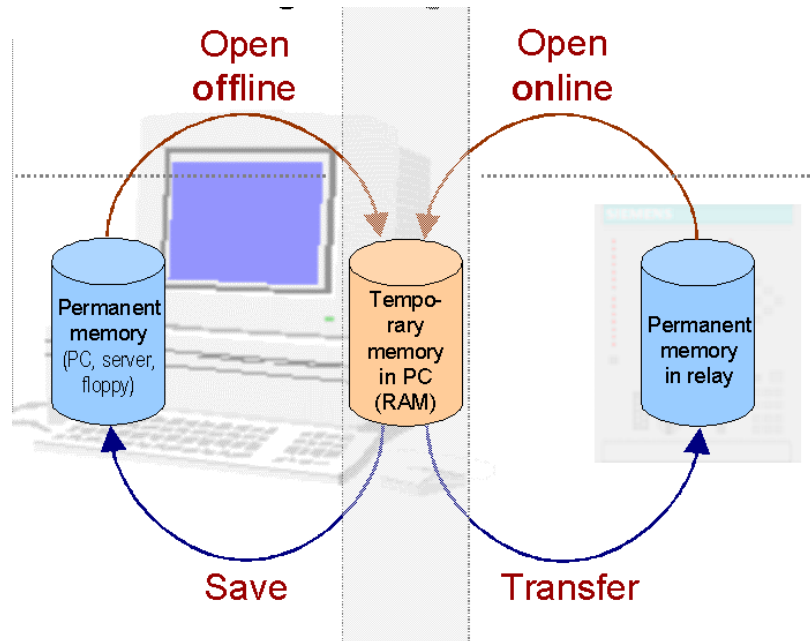

On-Offline.gif

Fig. 4-30 Managing DIGSI 4 devices, distribution of the parameters

Offline

Changes in the Offline operating mode initially only act on the temporary PC memory. If they are to be available permanently, they have to be saved explicitly in the permanent memory of the PC.

Online

Changes in the Online operating mode initially only act on the temporary PC memory. If they are to act in the device, they have to be transferred to the device.

4.4.1 Saving Setting Values in the Permanent Memory of the PC

Changes to the setting values are initially only carried out in the temporary memory of the PC. The source data in the permanent memory is at first unaffected. There is **no** automatic saving of changed setting values.

- Click on **File > Save** in order to save the setting values.



NOTE

You can only save setting values if no windows for displaying process data are open. If such a window is open, the contents of the active window are saved but not the setting values.

4.4.2 Transferring Setting Values to the Device

From the Permanent Memory of the PC

Proceed as follows in order to transfer the setting values to the device memory:

- Open the device in the **Offline** operating mode. The contents of the permanent memory are then transferred to the temporary memory of the PC.
- Click the **Device > DIGSI > Device** menu command.
- Enter the password for **Parameter set** in the **Password query** dialog box and confirm with **OK**.
- Select the type of online connection between the PC and the device.

The connection to the device is established and the setting values are transferred to the memory of the SIPROTEC device. After transfer has been completed, the link is automatically disconnected.

From the Temporary Memory of the PC

Proceed as follows in order to transfer modified setting values from the temporary memory of the PC to the device:

- Change any number of parameters and click in the dialog window on the **DIGSI > Device** command button or select the **Device > DIGSI > Device** menu command.
- Enter the password for **Parameter set** or **individual parameters** in the **Password query** dialog box and confirm with **OK**.



NOTE

The **DIGSI > Device** command button of a dialog window is only active if you have changed the setting value of at least one parameter.

Depending on the type of modified parameter, the new setting value can be transferred individually to the device or only in connection with the complete parameter set.

If you transfer the complete parameter set, a **Resume** of the SIPROTEC device is required (see Chapter 4.3.6).

4.4.3 Transferring Setting Values from the Device

After the Online connection has been established, all the setting values required for the device are loaded from the permanent memory of the PC into its temporary memory. These values are then compared with the transferred setting values of the connected device.

If the device data deviates from the PC data, the **Open Device Online** dialog box is displayed.

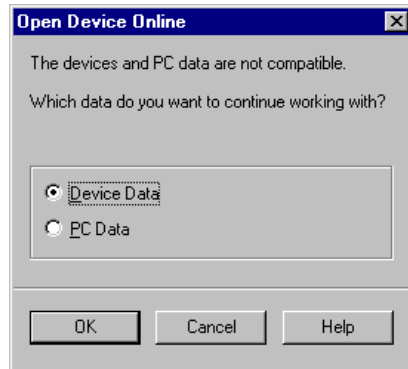

DIGSIB018

Fig. 4-31 Opening a device online

- Select the **Device data** option and click **OK**.

The setting values in the permanent memory remain unaffected by the selection.

Saving Device Data

If you have selected the **Device Data** option, the setting values from the device memory are stored in the temporary memory of the PC. If you want to save this data in the permanent memory of the PC, proceed as follows:

- Click **File > Save**.



NOTE

You can only save setting values if no windows for displaying process data are open. If such a window is open, the contents of the active window are saved but not the setting values.

4.4.4 Comparing Setting Values

Online / Offline Comparison

In the **Online** operating mode you can compare the parameter sets in the permanent memory of the PC with the data in the memory of a SIPROTEC device. A filter function allows you to select a subset for comparison from the maximum number of comparable parameters. As a result of the comparison, those parameters which differ between the two compared parameter sets are displayed.

Proceed as follows:

- Select **Device > Compare Parameters Online/Offline**.
The **Compare Parameters** dialog box is opened.

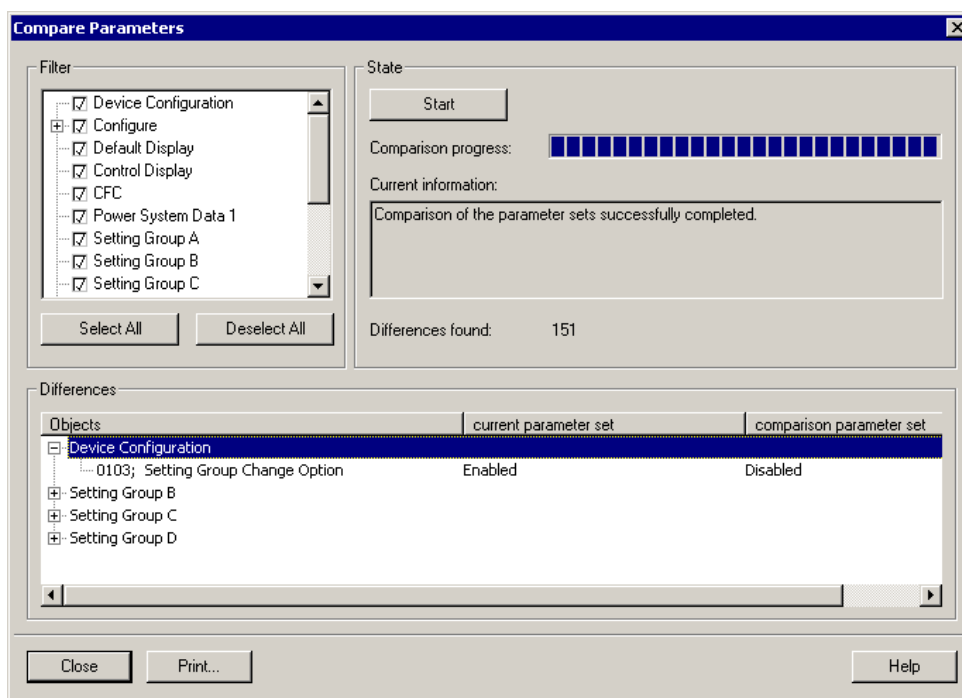

Fig. 4-32 Comparing parameters on/offline

The categories which can be selected are displayed in the **Filter** select box.

- Activate the check box before the designation in order to select the category.
- In order to exclude an activated category from the comparison, click on the check box. The check mark is deleted.
- If you want to select or deselect all the categories, click **Select All** or **Deselect All**.
- Click **Start** to launch the comparison of the parameter values. A segmented bar in the **State** box informs you about the current progress of the comparison.

When the comparison is completed, the number of differences found is displayed in the **State** section.

Detailed information on the differing values of individual parameters can be found in the **Differences** box.

The **Objects** column displays the designations of the individual parameters combined to categories identical to the **Filter** box.

The **Device parameter set** column displays the values of the parameters in the permanent memory of the SIPROTEC device.

The **File parameter set** displays the values of the parameters in the permanent memory of the PC.

- Click **Print** in order to print out the displayed results or to write to a print file. For further information on printing please refer to Chapter 4.10.
- Click **Close** to close the dialog box.

Offline / Offline Comparison

Proceed as follows in order to carry out an offline comparison of the parameter sets of different devices or variants:

- Open a device in the **Offline** mode and select **Compare Parameters** via the context menu.

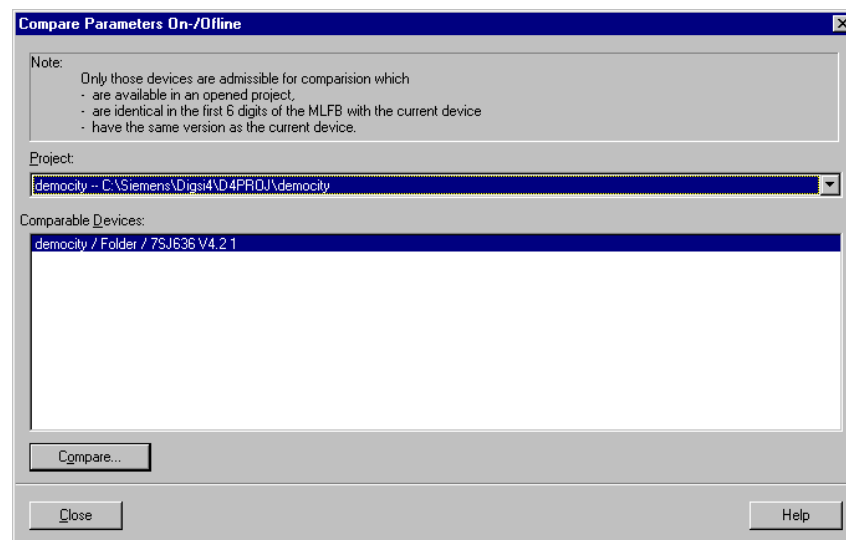

digs4700.gif

Fig. 4-33 Comparing parameters offline

- Select the desired device in the **Comparable Devices** list
- Click the **Compare** command button.

- Select the comparison criteria in the **Filter** selection box and click the **Start** command button.

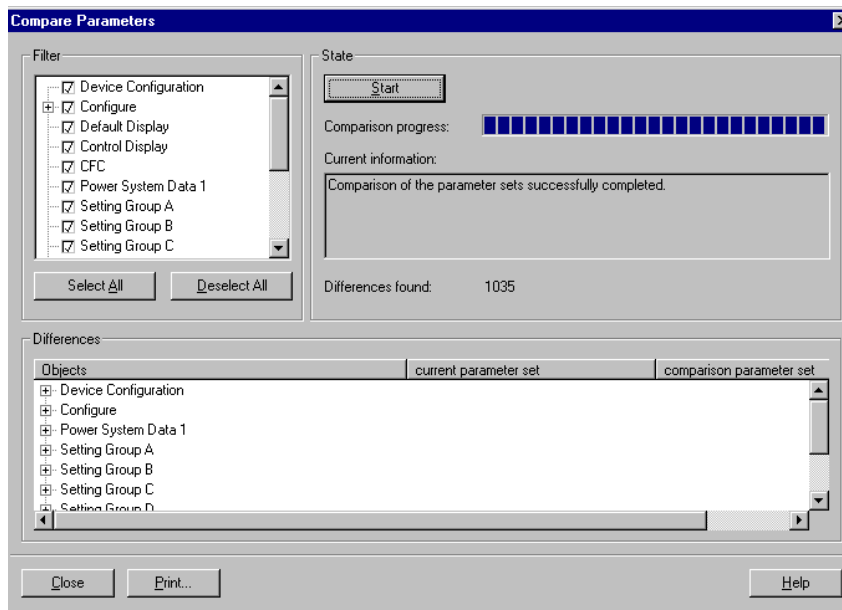

digsi701.gif

Fig. 4-34 Comparing parameters, filter

The differences between the two parameter sets are described in the **Differences** box.

4.5 Operating Language

DIGSI 4 differentiates between three areas to which you can assign different languages independently of each other.

- ❑ **DIGSI 4 operating language**
The selection of a language as the operating language acts on the language display of the DIGSI 4 menus.
- ❑ **PC device language**
The PC device language can be set specifically for a SIPROTEC device or a SIPROTEC variant. It influences, for example, the parameter names in the DIGSI 4 operating tree or in the configuration matrix.
- ❑ **SIPROTEC 4 device operating language**
The SIPROTEC 4 device operating language is specific for a SIPROTEC 4 device. The selection of a specific language influences the language display of the texts in the device display.

4.5.1 Setting the DIGSI 4 Operating Language

The DIGSI 4 operating language is set initially during the installation of DIGSI 4. Proceed as follows in order to change this setting:

- Use **Options > Settings** to open the **Customize** dialog box.

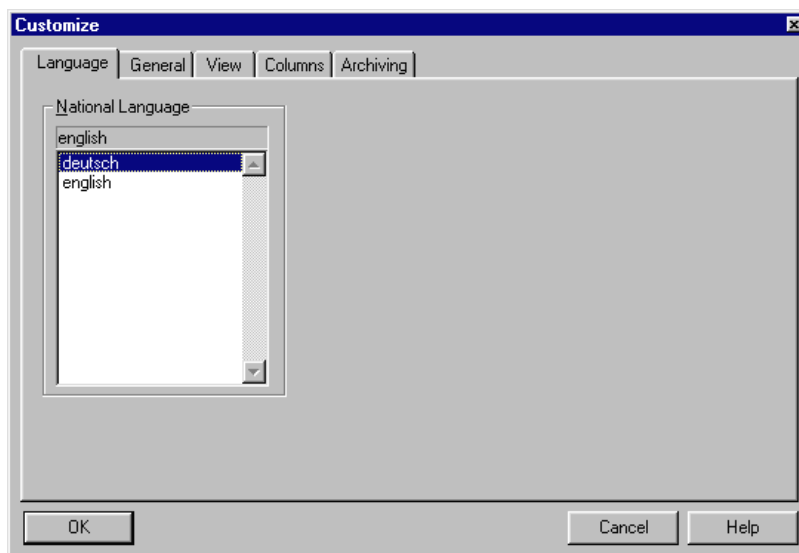

Fig. 4-35 Customize, Language tab

- Select the language in the **Language** tab in the **National Language** box and confirm your selection with **OK**.
- Restart the DIGSI 4 Manager in order for your selection to become effective.

The designations of all device-independent control elements and information are then displayed in the language you have selected.



NOTE

The language which is to be set as the DIGSI 4 operating language has to be installed on your PC.

4.5.2 Selecting the PC Device Language

Proceed as follows in order to set the PC device language:

- Select a SIPROTEC 4 device or a SIPROTEC 4 variant and use the **Object Properties** context menu to open the **Properties** dialog box.

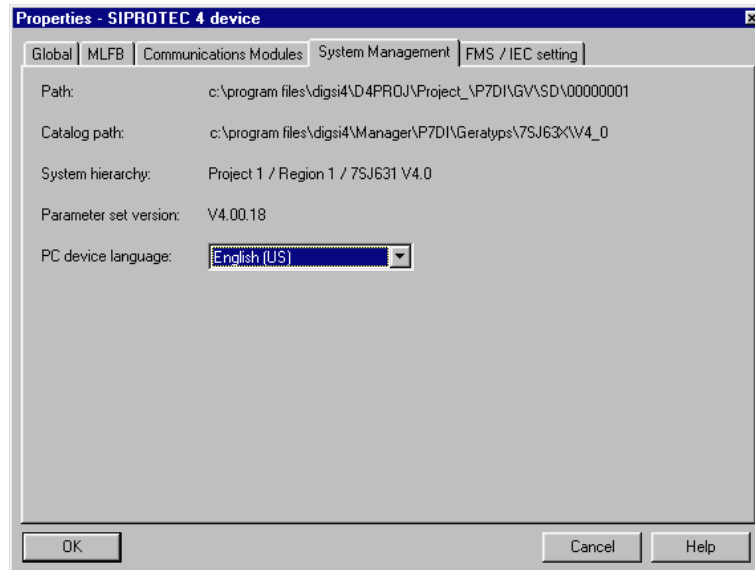

DIGSIMAN051

Fig. 4-36 Properties, System Management tab

- Change to the **System Management** tab and select a language from the **PC device language** drop-down list box.
- Confirm the message on the successful installation with **OK** and also close the **Properties** dialog box with **OK**.

The parameter names are now displayed in the language selected by you for this device.



NOTE

When you insert a SIPROTEC 4 device or a SIPROTEC 4 variant, the language which was specified as the DIGSI 4 operating language is assigned by default to the PC device language.

You can create your **own texts** in order to use these as the PC device language. The procedure is described in Chapter 4.9.

4.5.3 SIPROTEC Device Operating Language

Language selection is only possible if the device supports this function. This property can be seen from the MLFB number.

Proceed as follows in order to set the SIPROTEC 4 device language:

- Open the device and click in the navigation window on **Parameters**.
- Select the **Language** function in the data pane and use the context menu to open the **Change Device Operating Language** dialog box.

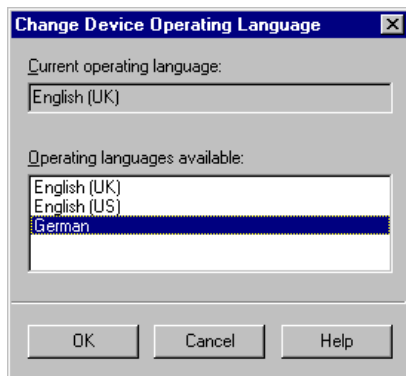

DIGSIB060

Fig. 4-37 Changing the device operating language

- Select the language in the Operating **language available** tab and confirm your selection with **OK**.



NOTE

If the **user-defined** entry is displayed in the select box, a file with user-defined device texts exists. For information on creating such texts please refer to Chapter 4.9.

4.6 Passwords

You can assign **passwords** in order to protect your SIPROTEC 4 device against unintended changes and operation of unauthorized operations.

The following **access authorizations** are preset at the factory:

- Switching/tagging/updating (Password No. 1)
- Unlocked switching (Password No. 2)
- Test and diagnostics (Password No. 4)
- Hardware test menus (Password No. 6)
- Single parameters (Password No. 5)
- Parameter set (Password No. 7)

Web Monitor

- Access authorization "Full access" (only for SIPROTEC B&B)
- Access authorization "Changes" (only for SIPROTEC B&B)
- Access authorization "Read only" (only for SIPROTEC B&B)

Via an Internet browser and with the help of the Web Monitor you can read out and change data from a SIPROTEC device. To control the access, corresponding access levels are introduced.

In addition to the passwords, you have to define the access levels in the interface dialogs.

Switchgear Passwords

Ten switchgear passwords are additionally available. They can be linked freely to any commands. A switchgear password can be assigned to different commands. The assignment of a switchgear password to a command is carried out in the properties dialog box of the command.

The password is requested for the corresponding function when carrying out operations with DIGSI 4 or at the operator control panel of the SIPROTEC 4 device.



NOTE

Password protection against unauthorized access is only active during **on-line** operation. The passwords for changing settings are not activated until the settings are downloaded to the device. They are irrelevant in the **Offline** mode.

In order to **de-activate** a password you have to know it!

Passwords can only be changed by means of **DIGSI 4**.

Proceed as follows in order to change an existing password:

- Open your device, double-click in the function view on **Passwords**, thus opening the **Passwords** dialog box.

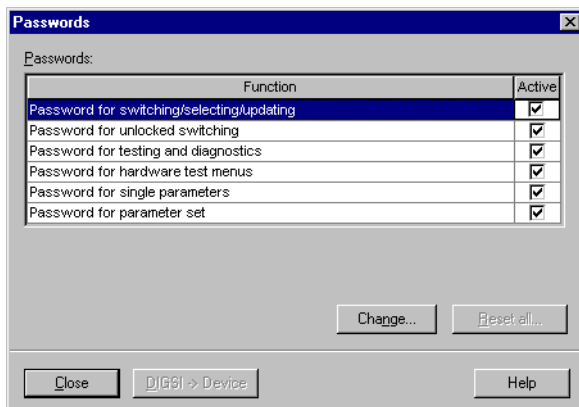

digsi011.gif

Fig. 4-38 Passwords

- Select the password function and click on the **Change** command button. The **Change Password** dialog box is opened.

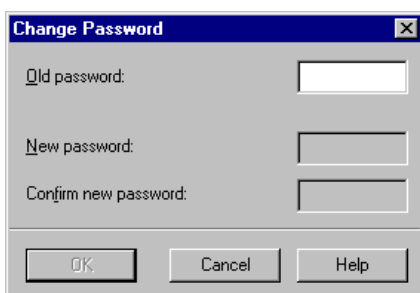

DIGSIGB037

Fig. 4-39 Changing the password

- Enter the old and the new password. An asterisk is displayed for each character you enter. As a confirmation enter the same sequence in the **Confirm new password** box.
- Confirm your entries by clicking on **OK**.

**NOTE**

- ❑ Passwords are numbers with a length of up to 8 digits.

At delivery all passwords are set by default to **000000**. The passwords for the Web Monitor are an exception: Here the default setting is **000002** for "Full access", **000001** for "Changes" and **000000** for "Read only".

- ❑ For Web Monitor access the following settings apply:

Operator interface Read only

Service interface Read only

System interface No access

You have to change these settings to get access to the SIPROTEC device.

**NOTE**

If you have forgotten your password for changing a parameter set, a temporary password can be obtained from our hotline. This can be used to define a new user password for this function. Our hotline requires the **registration number** of your **DIGSI 4** software package!

Deactivating a Password

Every password which is activated is identified by a check mark in the **Active** column. The passwords can be deactivated separately.

- Click in the **Active** column on the check box in order to deactivate the password.



DIGSIGB038

Fig. 4-40 Deactivating a password

- Enter the valid password in the **Password** input box. If you enter the correct password, the **OK** command button is activated. Confirm your entry by clicking on **OK**.

All the passwords are activated in the default setting of the parameter set. The passwords can be deactivated separately. Deactivation only applies to the current session. All the passwords are activated again when DIGSI 4 is restarted.



NOTE

If a password is deactivated, you are not prompted for a password prior to execution of the associated action or transmission of the command. Please note that this can have unintentional consequences!

Activating the Password

The individual passwords are activated independently of each other.

- Click in the **Passwords** dialog box on the check box of the password in the **Active** column. The password is activated without any further confirmation.

Resetting All the Passwords

If you have forgotten passwords, it is possible to reset all the passwords to the works setting. In order to avoid unauthorized resetting of passwords, resetting is protected by various means.

- In the **Passwords** dialog box click the button **Reset all**. The **Reset passwords** dialog box is displayed.

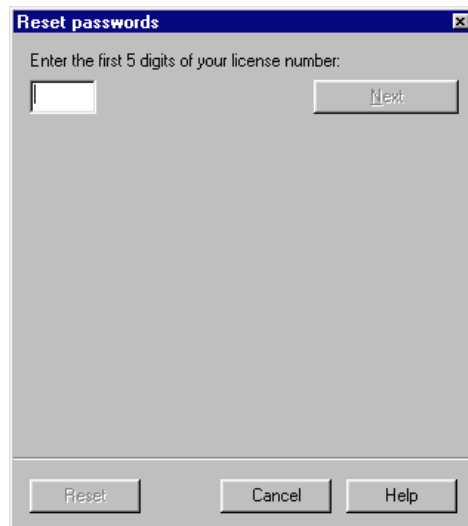

DIGSIGB100

Fig. 4-41 Resetting passwords before entering the license

- Enter the first five digits of your **DIGSI 4 license number** and click **Next**.

From this sequence DIGSI 4 calculates a DIGSI key in accordance with a special algorithm. This key is displayed in the **Reset passwords** dialog box.



DIGSIGB135

Fig. 4-42 Resetting passwords after entering the license

- Now call the DIGSI hotline. Inform your phone partner of your **license number** and the resulting **DIGSI key**. You will be given a **reset key**.
- Enter this value in the box provided and click **Reset**.

All the passwords have the original sequence assigned to them.



NOTE

The reset key given to you can only be used once.
If you have to reset the passwords again, you will have to repeat the procedure described.

- Click in the **Password** dialog box on **OK** in order to terminate the procedure.

Password Prompt

If an operator action, for example, switching or changing the parameter set, is protected by a password, the corresponding activated password is prompted by the **Enter Password** dialog box.

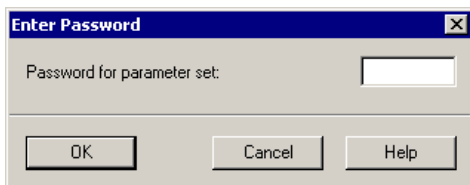

DIGSIB040

Fig. 4-43 Entering a password

- Enter the correct password in the **Password for...** field and then click **OK**.
- An incorrect password causes a fault indication. A correct one enables the protected action.

4.7 Exporting / Importing Data

The import/export function of the DIGSI 4 Manager provides many possibilities for managing your data. Company-internal security concepts or quality specifications for maintaining various data may make it necessary to source data out and make them available for further processing by employees in other departments.

The information which you can export and import includes

- ❑ The complete data scope of a SIPROTEC device
- ❑ Settings of protective functions in OMICRON format
- ❑ Fault record data in COMTRADE format
- ❑ Configurations and values of protection parameters in ELCAD or XRIO format
- ❑ Information configured to the system interface in DBASE or XML format
- ❑ Device and station data for a communication according to IEC 61850

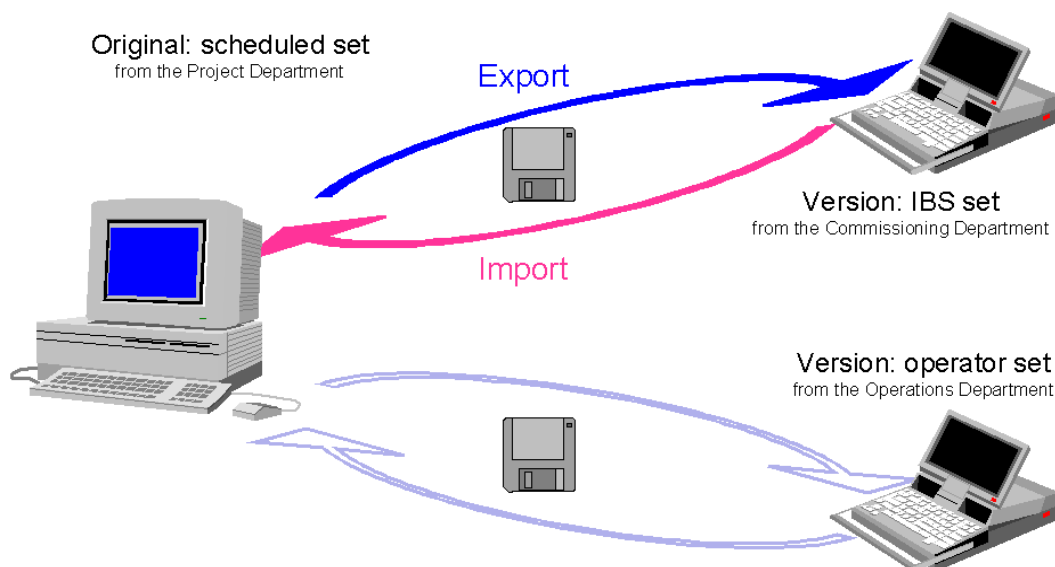

Im-export.gif

Fig. 4-44 DIGSI 4 Manager, data import/export

Both data from **SIPROTEC devices** and from **SIPROTEC variants** can be exported and imported. In addition you can import and export, in the course of a communication according to IEC 61850, the data from devices (also such devices made by other manufacturers) and stations.

During export, all the data belonging to a SIPROTEC device is packed and saved in a file. Compressing and extracting data is carried out automatically. All the required options are preset and cannot be changed. During import, the data of a SIPROTEC device are extracted from this file. They are then available for further processing.

4.7.1 Exporting the Data of a SIPROTEC Device

DIGSI 4 Manager supports the export and import of device and station data. During export, all data belonging to a device or an IEC 61850 station are packed and saved in a file. During import, the data is extracted from this file. They are then available for further processing.

Exporting and importing device and station data may be necessary for the following reasons:

- You want to manage device data in an archive and use as required.
- You want to transfer device data to another project on another PC.
- You want to integrate devices by other manufacturers, which are suitable for IEC 61850-type communication, into your system topology.
- You want to process station data with the system configuration of another manufacturer.
- You want to integrate stations, which have been configured with the system configurator of another manufacturer, into your system topology.

Proceed as follows in order to export the data of a **SIPROTEC device** or of a **SIPROTEC variant**:

- In the data pane of the DIGSI 4 Manager select the device whose data is to be exported and use the **Export Device** context menu to open the **Export** dialog box.

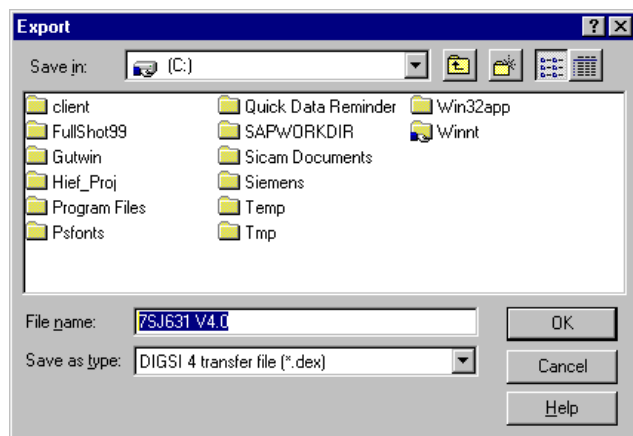

DIGSMAN059

Fig. 4-45 Exporting

- Select the drive and directory and specify the name of the export file. DIGSI 4 suggests the name of the selected object. The transfer file has the extension **.dex** for SIPROTEC 4 devices, **.de3** for SIPROTEC 3 devices and **.de2** for SIPROTEC 2 devices. During export for an IEC 61850-type communication, the suffixes **.icd/.cid** (device) or **.scd** (station) are used. SIPROTEC 4 devices allow data to be exported in XML and XRIO format (file extensions **.xml** and **.xrrio**).
- Confirm your entries by clicking on **OK**. The exporting process is started.

**NOTE**

Please note that only data located within the device directories generated by DIGSI 4 can be exported.

HV project description files assigned to a process control device are, for example, usually not stored within these directories and are therefore not exported. SIEMENS therefore recommends exporting the HV project description files separately.

**NOTE**

You can edit the exported XML file directly and then re-import it into a SIPROTEC 4 device. This enables you to change the settings of single parameters without using DIGSI. For instance, you can create type-related device templates where only individual values differ.

The following data is exported:

- text and decimal parameters with this parameter address and their values
- information items in the device matrix and their values

You can use the EXCEL Add-In **DIGSI XML Interface**, which is freely available in the SIPROTEC download area (www.siprotec.de), to create the XML code that can be imported by DIGSI directly from the setting sheet.

**NOTE concerning the XRIO export**

The XRIO format was developed by OMICRON based on the RIO format and allows data to be exchanged between test systems and any protection configuration systems. XRIO is based on XML and gives direct access to single parameters and their values.

4.7.2 Importing Data

The data of SIPROTEC devices can be imported into various targets. Which target you select affects how you can continue to use the imported data.

4.7.2.1 With DIGSI transfer file

Into a New Object

- ❑ **Object Type SIPROTEC 4 Variant**
If you select this object type as the destination, the VD address contained in the import data is also assigned to the newly created object. This procedure enables you to communicate directly with the **SIPROTEC 4 device** from which the data was originally exported. In this context, directly means that the **SIPROTEC 4 device** does not have to be reinitialized. The disadvantage of this procedure is that objects of type **SIPROTEC 4 variant** do not support coupling with SICAM plusTOOLS.
- ❑ **Object Type SIPROTEC 4 device**
Importing data into this object type means that the newly created object is assigned a new VD address which is not yet assigned in the current project. Thus, communication with a **SIPROTEC 4 device** on the basis of the imported data means that this device needs to be initialized. The advantage of this procedure is that objects of type **SIPROTEC 4 device** support coupling with SICAM plusTOOLS.
- ❑ **Object types SIPROTEC 2 variant and SIPROTEC 3 variant**
If you select this object type as the destination, the IEC address (device address) contained in the import data is also assigned to the newly created object. This procedure enables you to communicate directly with the **SIPROTEC 2** or **SIPROTEC 3** device from which the data was originally exported. In this context, directly means that the SIPROTEC device does not have to be reinitialized.
- ❑ **Object Types SIPROTEC 2 device and SIPROTEC 3 device**
Importing data into this object type means that the newly created object is assigned a new IEC address (device address) which is not yet assigned in the current project. Thus, communication with a **SIPROTEC** device on the basis of the imported data means that this device needs to be initialized.

Proceed as follows in order to import data:

- In the project structure of the DIGSI 4 Manager select the level under which you want to create the new **SIPROTEC variant** and use the **Import Device** context menu to open the **Import device** dialog box.



DIGSMAN079.tif

Fig. 4-46 Importing a device

- Select from the drop-down list box **Type** which version of a SIPROTEC device you want to import.
- Select the option for the target and confirm it with **OK**.

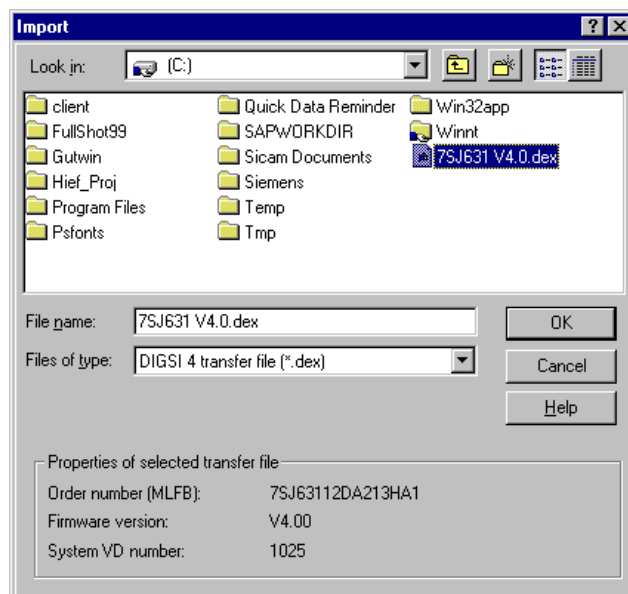

DIGSMAN060

Fig. 4-47 Importing, importing into a new object

- Select the name of the file with the extension **.dex** which contains the data to be imported in the **Import** dialog box.

The properties of the SIPROTEC device whose data you want to import are displayed for verification.

- Confirm your entries by clicking on **OK**.

After the importing process has been completed, a new object of the selected type has been added to the project structure.

Into an Existing Object

Data of a SIPROTEC device can be imported directly into an existing **SIPROTEC device**.

As a precondition, the values of various properties of the target object must be identical to the data which is to be imported. For **SIPROTEC 4 devices**, these are the order number, the parameter set version, the parameter set ID and the VD address. For **SIPROTEC 2 and SIPROTEC 3 devices**, these are the order number, the firmware version and the IEC address (device address).



NOTE

All the existing data of the existing **SIPROTEC device** is deleted during the importing process!

Proceed as follows:

- In the DIGSI 4 Manager select the **SIPROTEC device** into which the data is to be imported and use the **Import Device** context menu to open the **Import** dialog box.

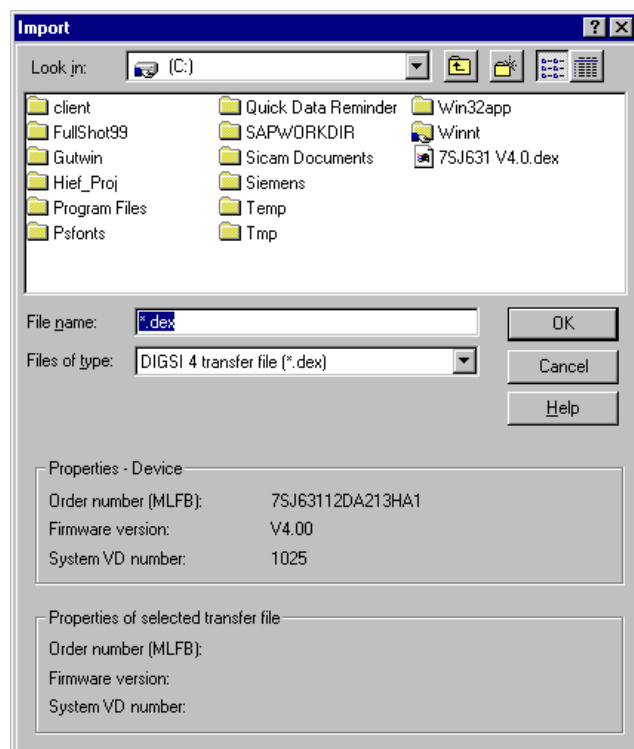

DIGSMAN061

Fig. 4-48 Importing, importing into an existing object

- Select the transfer file and click **OK**.

Before importing the data, DIGSI 4 compares the properties of the device and the transfer file with each other. If they do not agree, importing is rejected.

4.7.2.2 Import with XML file

DIGSI 4.80 features a complete XML interface for exchanging protection settings and signal interconnections for all devices of the SIPROTEC 4 series.

The export function enables users to transfer all protection settings and signal configurations of a device into other applications in a readable and well-structured format where they can be processed, documented and managed.

This process is also possible the other way round: Via the import interface, users can read in data from other applications (the data may have to be converted first) into DIGSI. An external parameter configuration is now possible.

Here some examples:

- Taking over data from power system calculation programs
- Replacing electro-mechanical devices with SIPROTEC 4
- Taking over data from setting sheets

Using the XML import, you can also carry out the following actions:

- Adding information groups and information items

To this end, you can copy existing objects in the XML file and adjust them. If you want to add new information items via the XML import, the "Type=" attribute is important. The number to be assigned here defines the information type. To find an assignment of the information types to the type numbers, see Assignment of the message types to the information types (Info type).

- Deleting information groups and information items

a) Informations groups

The behavior is adjusted by means of the **Option** attribute:.

Value of Option	Behavior during import
Standard	Only the information in the XML file is edited; all other information items remain unchanged (standard behavior)
DeleteGroup	Deletes the entire group including all information items in the group
Complete	Deletes all information items of the group except for the information contained in the XML file itself

Example:

```
<Group Name="New Group" TextRef="316,65532" Option="Complete">
<Information Number="001" Name="Info 1" TextRef="316,65533" Type="106"/>
<Information Number="002" Name="Info 2" TextRef="316,65534" Type="106"/>
<Information Number="003" Name="Info 3" TextRef="316,65535" Type="106"/>
</Group>
```

b) Information

Each user-defined information item has the Delete attribute:

Value of Delete	Behavior during import
yes	User-defined information is deleted
no	User-defined information is processed normally (standard behavior)

4.7.3 Exporting the Settings of Protection Functions



NOTE

The RIO export has been included in the XRIO export function (see Chapter 4.7.1). We recommend using the XRIO export.

DIGSI 4 can export various settings of protection functions in OMICRON format. These are the setting values of those parameters that can be processed on the 7VP15 test equipment from OMICRON.

This export function is called up from the dialog boxes of the DIGSI 4 Device Editor in which function settings are carried out. These dialog boxes contain the **Export** command button which is active when the processed SIPROTEC device contains functions which can be tested by the 7VP15 test equipment.

Proceed as follows:

- Click on the **Export** command button and thus open the **RIO Export** dialog box.

Maximum values

Maximum voltage (interlinked): 120 V

Maximum current: 10 A

Tolerances

Tolerance of time zones (TOL-T): 1 % (rel.) 1 (from)

Tolerance of impedances (TOL-Z): 5 % (rel.) 0,1 (from)

Factors

Complex grounding factor power (KS): 1 R 0 X

Complex power impedance (ZS): 0,259 R/Ohm 0,966 X/Ohm

Maximum permissible fast time (TIMEOMAX): 0,1 s

Correction of fault impedances by factor I/I(nom.): FALSE

OK Cancel Help

DIGSIGB053

Fig. 4-49 RIO Export

- Set the OMICRON-specific parameters and confirm your entries with **OK**.

The parameters are described in the manuals of each item of OMICRON test equipment.

The **Save As** dialog box is opened.

4.7.4 Exporting Fault Record Data

Fault record data can be exported in the COMTRADE format to make it available to evaluation programs in order to analyze the fault. The fault data of a fault record are exported in ASCII format as primary values. Some SIPROTEC 4 devices do not have fault records (e.g. 6MD63 and 6MD66).

Proceed as follows:

- Open the device, select the name of the fault and click in the context menu on **Export**.

If the selected SIPROTEC device has a distance protection function, data on the trip characteristic are also exported. This data can be represented as a zone diagram by means of an appropriate evaluation program such as SIGRA.

Settings for the trip characteristic may vary depending on the available parameter groups. First select a parameter group.

- In the **Select Parameter Group** dialog box, select the parameter group whose settings are to be exported for the trip characteristic and click **OK**.

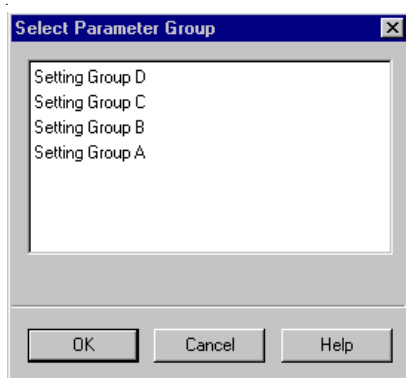

DIGSIGB124

Fig. 4-50 Selecting the parameter group

The **Export** dialog box is opened.

- Enter a name and the storage location for the export file and click **OK**. The file type **.cfg** is preset.

**NOTE**

The fault record data is saved in files with the extensions **.cfg**, **.dat** and **.rio**.

4.7.5 Exporting Configurations and Protection Parameters

For documentation purposes all protection parameters, configurations to binary inputs, outputs, LEDs and the system interface can be exported in ELCAD, CSV, XML or XRIO format. The parameters and configurations are distributed on individual sheets and stored in a file.

- In the ELCAD format, parameter values and configurations are distributed on individual sheets and stored in a file.
- In the CSV format (Comma Separated Values), data is saved row-wise in a file and separated from each other by semicolons. Such files can be opened with many table calculation programs.
- The XRIO format was developed by OMICRON, on the basis of the RIO format, to exchange data between their test systems and any protection configuration systems. XRIO is based on XML and allows direct access to individual parameters and their values.

**NOTE**

In case of an ECLAD export, the file can only be opened by current ELCAD program versions. Older program versions are not able to import several sheets from a file.

- The XML export/import function allows the exchange of configurations and protection settings (see also Chapter 4.7.2.2).

Proceed as follows:

- Open the device and use the **Export > Configuration and Protection Parameters** menu command to select the **Export - Configuration and Protection Parameters** dialog box.
- Enter the name, storage location and filetype for the export file and click **OK**.

Once you have selected the ELCAD format, the **Export - ASCII/ELCAD** dialog box is opened.

DIGSIGB150

Fig. 4-51 Export - ASCII/ELCAD

- Carry out the following entries:
 - System archive**, name of the system archive
 - Level 2**, designation of the documentation type
 - Level 3**, designation of the Z part
 - Level 4**, short designation of the sheet
 - Level 5**, number for the sheet number
 - Type of form sheet**, abbreviation for the type of form sheet.
The abbreviation entered must exist in the form library of the ELCAD target system.
- Select the **Use as standard** check box so that the entered information is saved for further exporting processes.

4.7.6 Exporting System Interface Information

All the information configured to an IEC system interface can be exported. This ensures, for example, that you can process the contents of the configuration matrix with EXCEL for documentation purposes.

Data such as information text, function number and information type are saved in DBASE format.

Proceed as follows:

- In the DIGSI 4 use **File > Export > System Interface** to open the **Exporting Interfaces** dialog box.

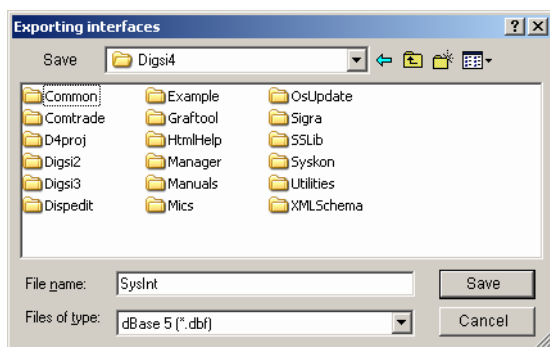

DIGSIB162.tif

Fig. 4-52 Exporting Interfaces

- Enter the name and storage location for the export file and click **OK**. The file type **.dbf** is preset.

The **Report** window is opened. Progress of the export process is shown in the **System Interface Export** tab.

4.7.7 Exporting CFC charts

DIGSI 4 can export CFC charts starting with version 4.83. The exported charts are stored in XML format, as ST code basing on IEC 61131 standard, in a file with the extension **.stx**.

You can import this export file into other applications and continue to use the CFC charts there. It is not possible to import the exported CFC charts in DIGSI 4.



NOTE

The CFC charts must be translated anew before exporting them. Translation changes the parameter set for the device. If you do not want to change the parameter set, create a copy of the device and export the CFC charts from the copy.

Proceed as follows:

- Translate the CFC charts with DIGSI V4.83 or a newer version.
Translate the CFC charts even if the charts have been translated with a previous version.
- Select the DIGSI 4 menu item **File > Export > CFC charts**.
The export dialog is opened.
- Enter a name and storage location for the export file and click **OK**. The file type **.stx** is predefined.

A message informs you of the completion of the export.

4.8 Updating the SIPROTEC 4 Device Types

The basic data of SIPROTEC 4 device types are constantly being developed further and improved. With each new version of **DIGSI 4**, the updated device types are included on the **DIGSI 4 installation CD**.

Device types which become available after new DIGSI 4 versions are released can be downloaded via the Internet under **www.siprotec.de** and installed subsequently. They are then available in the device catalog.

4.8.1 Installing New Device Types

Proceed as follows in order to install new device types:

- Close all the DIGSI 4 program components before beginning with the installation of SIPROTEC 4 device types.
- Insert the DIGSI 4 installation CD and activate **Setup.exe** in the ...:\Disk1\Siprotec\ directory.
- Follow the installation instructions until the **Install or Update Device Types** dialog box is opened.
- Select the **Install New Device Types** option.
- Click **Next**, select the language and click again on **Next**.

The **Install device types** dialog box is displayed.

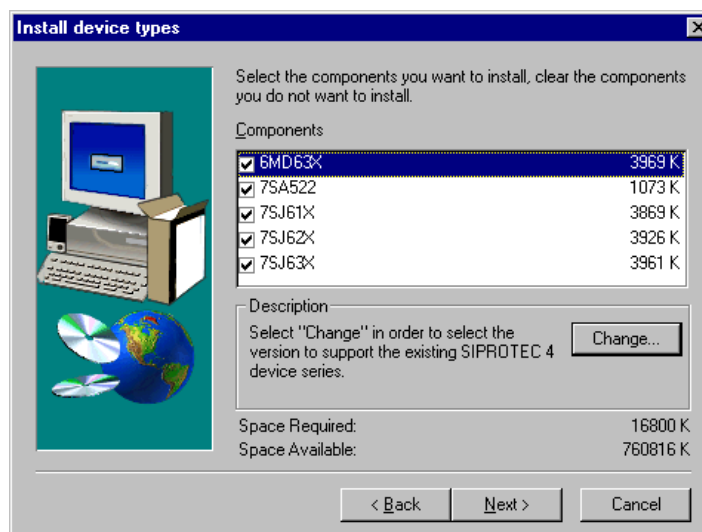

DIGSIMAN082

Fig. 4-53 Installing device types

- Select all the devices which you want to install in the **Components** box.

The names in the **Install Device Types** dialog box represent groups of devices. The devices have been grouped by common applications, such as 7SJ61x.

The names of all the type groups are selected by default.

If the selected device types also include such types which are already installed on your computer, these are updated.

- If you want to change the version of a device type, select a device and use the **Change** command button to select the **Select Sub-components** dialog box.

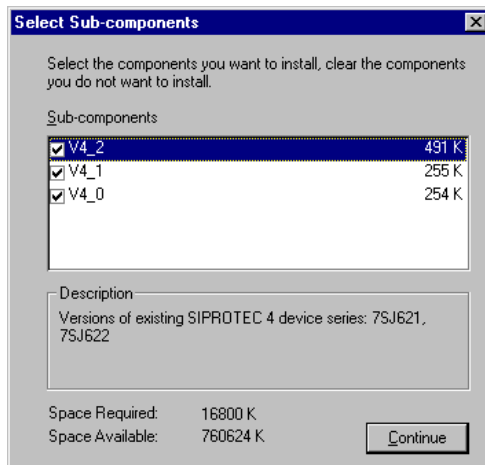

DIGSIMAN083

Fig. 4-54 Selecting sub-components

- Select the designations of the versions which are to be installed and click **Continue**. The dialog box is closed. You return to the **Install device types** dialog box.
 - Click **Next** to start the installation process.
- During the installation a message box indicating the progress is displayed.

4.8.2 Updating Existing Device Types

Proceed as follows in order to update existing device types:

- In the **Install or Update Device Types** dialog box select the **Update existing device types** option.
- Click **Next**, select the language and click **Next** again.

The **Specify scope** dialog box is displayed.

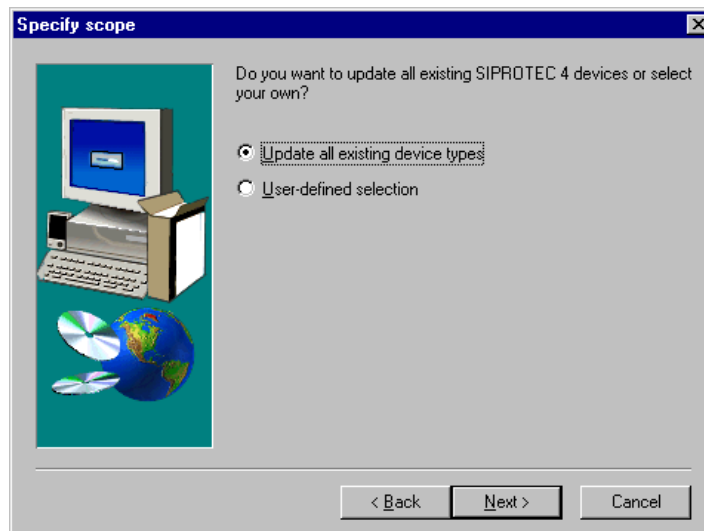

DIGSIMAN084

Fig. 4-55 Specifying the scope

- Select the **Update all existing device types** option if all the device types installed on the computer are to be updated and then click **Next**.

The updating process is started immediately.

- Select the **User-defined selection** option if you want to specify which installed device types are to be updated and click **Next**.
- Select the devices which are to be updated in the **Components** box of the **Update device types** dialog box and click **Next**.

You can extend the updating process into an installation process by selecting the new type groups (see Chapter 4.8.1).

4.8.3 Updating existing SIPROTEC 4 Devices in Projects

The installation of new device types or the updating of existing device types in DIGSI 4 only acts on the device types which can be selected in the device catalog. **SIPROTEC 4 devices** or **SIPROTEC 4 variants** already inserted into projects are not influenced automatically. DIGSI 4 offers a possibility of updating these objects. During this procedure, the parameter set and the device text are updated. Updating the existing device allows the use of a newer functionality without having re-created the relevant objects.

The parameter set is identified by a version number. At the moment of selecting a device in the device catalog you identify it by means of the version number. The selection displayed here depends on your selection of the device types.

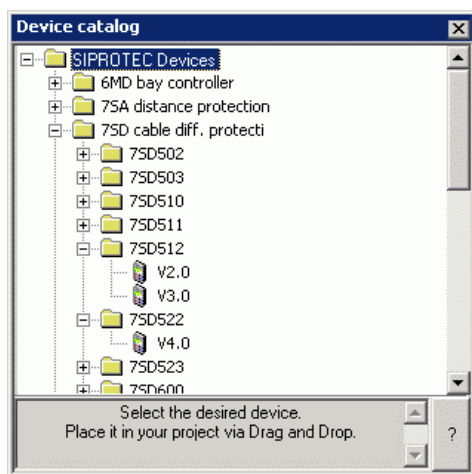

DIGSIMAN007

Fig. 4-56 Device catalog



NOTE

If you update a parameter set so that the first decimal point of its version number changes, the firmware of the corresponding SIPROTEC 4 device must also be updated under all circumstances. On the other hand, when you load a new firmware into a SIPROTEC 4 device, you do not have to update the corresponding version number under all circumstances.

However, this is not the case where the second decimal point of the version numbers differs. This difference is not displayed directly in the device catalog. For example, you would choose version 4.0 in the device catalog whether the device version is 4.00 or 4.01. The current parameter set version with two decimal places is displayed within the status area at the bottom of the device catalog.

- In order to check the version number of the parameter set of a SIPROTEC 4 device within a project, select the device and use the **Object Properties** context menu to display the **Properties - SIPROTEC 4 device** dialog box.

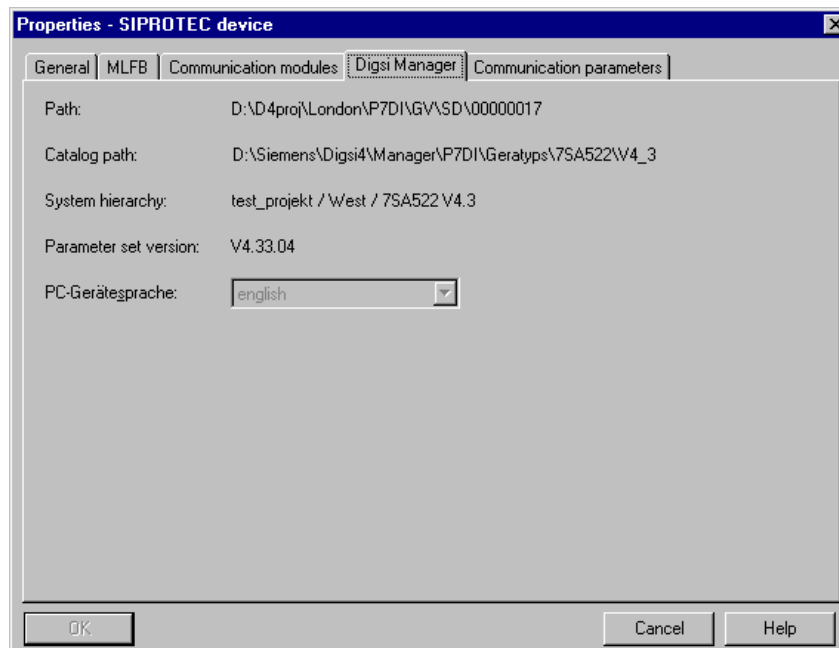

DIGSiman051.tif

Fig. 4-57 Properties - SIPROTEC 4 device, DIGSI 4 Manager tab

The **DIGSI Manager** tab contains the current version number of the parameter set.

If you have installed the current parameter set versions in the device catalog, proceed as follows in order to update your devices in the project:

- Select the **SIPROTEC 4 device** or the **SIPROTEC 4 variant** and use the **Update parameter set** context menu in order to update the **Update parameter set** dialog box.

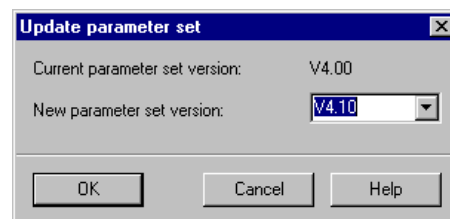

DIGSIMAN075

Fig. 4-58 Update parameter set

The version number of the parameter set currently used and the highest available version number are displayed. If no version number is displayed in the **New parameter set version**, there is no parameter set with a higher number than the current version number installed on your computer.

- Select the version number to which the parameter set is to be updated in the **New parameter set version** drop-down list box and confirm your selection with **OK**.

The **Report** window is opened. There you can follow the conversion process in the **Indications** box.

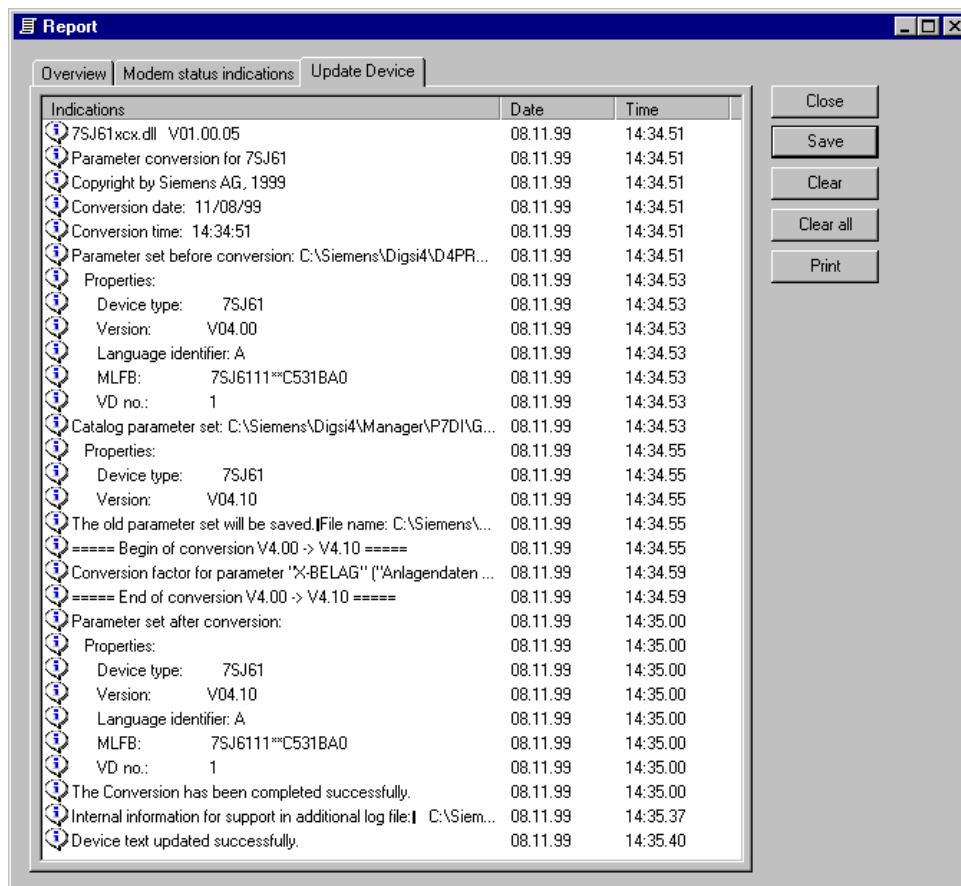

DIGSIMAN076

Fig. 4-59 Report, example

The end of the update is indicated in the report.

- Close the **Report**.

Adapting Object Names

When a **SIPROTEC 4 device** or a **SIPROTEC 4 variant** is inserted, DIGSI 4 automatically assigns an object name which also includes the version number of the current parameter set. The name is not adapted during updating!

- Update the object names with regard to the new version number manually.



NOTE

Please contact the DIGSI 4 Hotline if problems occur after the update. Please keep the files with the extensions **.txt** and **.log** at hand. The path of these files is displayed in the message box when the device is updated (see Figure 4-59).

4.9 Creating and Using User-defined Device Texts

All texts belonging to the language selected as the PC device language or device operator language are stored in a file. If more than one language is available, each language has its own file.

Nowadays, there are two different formats of these text files. The classical .dbf or the current .xml. XML is offered for the following device series: 7SJ68, 7Sx80 and 7SS522. DIGSI prefers .xml to the .dbf files. The name of such a text file consists of

- ❑ the type group designation of the SIPROTEC 4 device,
- ❑ the classification letter for the language with .DBF files or the ISO language identifier with .XML files,
- ❑ the file extension **.dbf** or **.xml**.

For example, the file 7SJ63x_a.dbf contains texts in German for SIPROTEC 4 devices of type 7SJ63x (7SJ631, 7SJ632, etc. The 7SJ80X_DIG_de-DE.xml file is its XML counterpart.

In addition, there is a file called **ChrDef(x).dbf** or **sip4_CHR_(xx).XML** for each language, where (x) stands for the language classification letter such as "a" for German or "b" for English and (xx) for the ISO language identifier such as "de-DE" or "en-GB".

You can create your own texts using appropriate programs. These device texts can then be selected as the PC device language or device operator language.

The files are stored in the path ..\Manager\p7di\geratyps\ or in one of the following type groups, e.g., k:\Siemens\DIGSI4\Manager\p7di\geratyps\7SJ63x.

Proceed as follows:

- First of all, create a **copy** of the three related files, for example, of the **7SJ63x_a.dbf** (or **7SJ80X_DIG_de-DE.xml**), **ChrDefa.dbf** and **sip4_CHR_de-DE.xml**.
The original files must not be changed!
- In the name of the file copies, change the language classification letter to **i** or to **x-user** with XML files.

If DIGSI 4 finds a language file with this identifier in the specified path, the entry **User-defined** is added to the corresponding fields in the dialog boxes for language selection. For further information on selecting the language, please refer to Chapter 4.5.

- Open the copied file, for example, **7SJ63x_i.dbf** with an editor that supports dBase and edit the entries in the fields **Text** and **D_Text**. Of course, this also applies to the **7SJ80X_DIG_x-user.xml** file where you can change the values for **text** and **digsiText** using an XML editor or an ASCII editor such as Notepad.

The **Text** field specifies the short text. The maximum number of characters is specified in the column **L** or in the XML element **len**. Do not use any special characters. The **D_Text** or **digsi-Text** field specifies the display text. The maximum number of characters is specified in the column **D_L** or **digsiLen**.

Do not carry out any changes to the remaining entries!

- Save the file.

4.10 Printing

Various items of project information can be printed out for documentation purposes. To prepare the project information for printout, use the standard functions of Windows:

- To select and set up a printer. Here you specify the paper format, font, printing quality, etc.
- To specify the layout of a page. Here you specify the contents of the headers and footers, margin, etc.

The object list is only printed out completely in landscape format.

After these preparations have been carried out you can

- Start the printout of an object list or
- Start the printout of selected information.

4.10.1 Printing an Object List

Information about the objects in your project is printed out in the form of an object list. This list provides the information of the tree view or of the Content window.

Proceed as follows:

- Use **File > Print > Object List** in DIGSI 4 Manager to open the **Print Object List** dialog box.

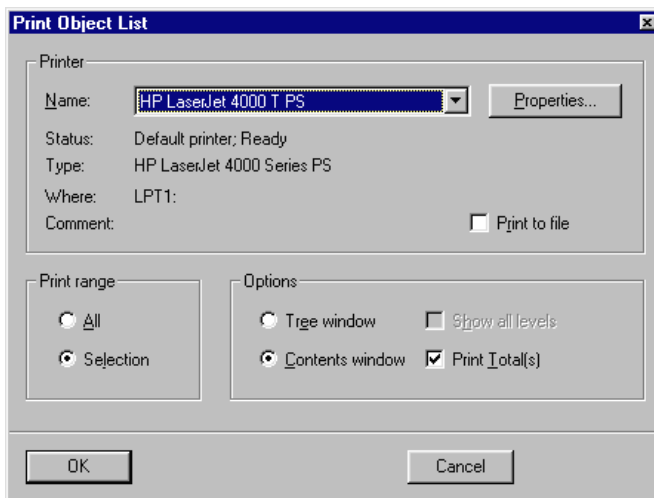

DIGSIMAN069

Fig. 4-60 Printing an object list

- Select the printer which you want to use as an output device.
- Select the **Print to file** check box to divert the printout to a file. The print data is then not sent to the printer, but stored in a file.

- Select the option **Tree window** in order to print the structure of the visible tree view. If all objects within the tree view are to be printed, you can optionally select the check box **Show all levels**.
- Alternatively select the **Contents window** option in order to print the information on visible objects within the list view. This is the information that is also displayed in the detailed view. The information is summarized in a table which contains the object name, type, size (always 0), author, change and comment.
- If you select the **Print Total(s)** option, the values in the Size column are added and output.
- Select the **All** option in order to print the complete visible area of the tree view or of the list view.
- On the other hand select **Select** option in order to print only information on the selected object. The **Select** option is, however, only active if an object is really selected in the view to be printed.
- Click **OK** to start printing with the settings you have made.

The printed information is supplemented by the name of the selected object and its path within the project hierarchy.

The header and footer of each page contain the information which you have specified.

The object list is only printed out completely in landscape format. If the paper format Portrait is preset, a confirmation query is displayed before printing begins.

4.10.2 Printing Selected Information

Instead of printing the contents of a window, you can select specific items of information and print them altogether.

Proceed as follows:

- Open the device whose information you want to print.
- Use **File > Print** to open the **Print Options** dialog box.

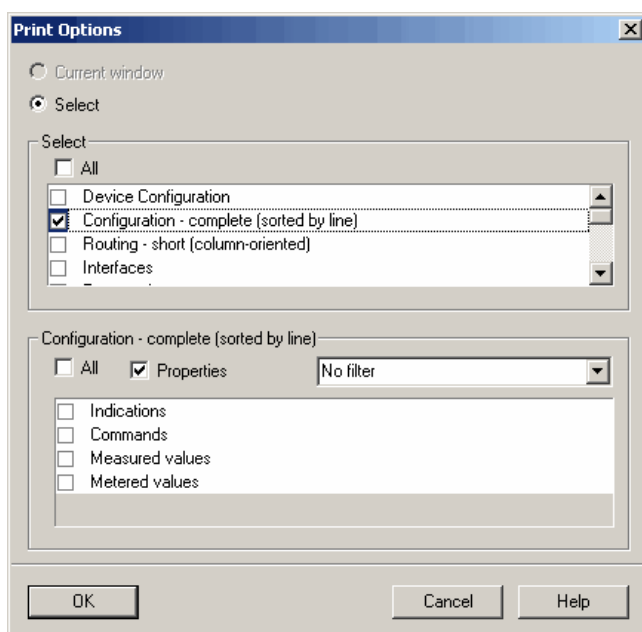

DIGISGB095

Fig. 4-61 Print selection

- Select all areas whose information items you want to print in the **Select** field. For some areas, you can make a more detailed selection of the information to be printed. If such an area is marked and selected, a further field is displayed in which you can select the required partial information or activate the **All** check box.
- Confirm by clicking **OK**.

4.10.3 Print Preview

The print preview option lets you check whether the scope of the information to be printed meets your requirements and subsequently start printing. If required, you can set up the printer and set print options beforehand. There is one more option that allows you to save your compiled information in XML format.

4.10.4 How to print selected items of information to file

Instead of printing information to paper, you can save this data to a file. Select the format TXT, HTML, or XML.

To print selected items of information to a file:

- In the menu bar, click **File > Print to file**. The **Print Options** dialog box opens.
- Select all areas whose information items you want to print in the **Select** field. For some areas, you can make a more detailed selection of the information to be printed. If you mark and select such an area, a further field is displayed.

- Select the required partial information in this field. To print all the partial information of an area, select the **All** check box in the second field.
- To print the entire information in all areas, select the **All** check box within the **Select** field.
- Click **OK** to apply your selection. The **Save as** dialog box opens..
- Enter a name for the print file and select one of the file types .txt, .html or .xml.
- Select a storage location for the file.
- Click **OK**.



Configuration

When SIPROTEC devices are configured, specifications are made with regard to the functional scope, configuration, etc.

This chapter describes the basic procedure for configuring a SIPROTEC device. The settings and functions shown in the following chapter are only examples as the settings and functions will vary depending on the selected device.

Contents

5.1	Parameter Settings Overview	166
5.2	Properties of a SIPROTEC 4 Device	169
5.3	Specifying the Functional Scope of a SIPROTEC 4 Device	172
5.4	Using Settings Groups	174
5.5	Allocating Information Items	178
5.6	Displaying Information	202
5.7	Inserting and Deleting Information	204
5.8	Properties of Items of Information	212
5.9	Configuring the Metered Value Restoring Function	227
5.10	Configuring Chatter Blocking	228
5.11	Setting Measuring Transducers	230
5.12	Configuring Limit Measured Values	231
5.13	Creating User-definable Functions with CFC	232
5.14	Editing Default and Control Displays	233
5.15	Setting Interface Settings	282
5.16	Date and Time Setup	283
5.17	Setting Further Parameters	291
5.18	Editing Parameter Settings in Settings Groups	292
5.19	Working with User-defined Characteristics	297
5.20	Using Zone Diagrams	300
5.21	Setting the Order of Fault Indications	302

5.1 Parameter Settings Overview

When setting the parameters of your SIPROTEC 4 device you specify:

- Which functions you want to use,
- Which data, measurement quantities and commands you want to detect/output via which inputs/outputs,
- Whether you have to interconnect user-definable functions with DIGSI 4 CFC,
- Which information the device display is to display,
- Which interfaces you want to use,
- How the internal clock is to be synchronized.

The **initial setting** of your SIPROTEC 4 device can be carried out by means of DIGSI 4 in **Offline** operating mode. A connection to the device is not required.

If you want to **change settings** later, you can do so in the **Online** operating mode or in the **Offline** mode.

The operating and setting possibilities in the offline and online operating modes are described in Chapter 4.3.3. Information on editing and saving the setting values can be found in chapter 4.4.



NOTE

Online changes of the configured parameter settings and the CFC configuration are protected by the **Password for parameter set**.

Online changes of the individual parameter settings are protected by a **password for individual parameters**.

How to Proceed

- First insert the device into your project (see chapter 4.3.1).
- Use the **Object properties** of the device via the context menu, check the settings and, if necessary, carry out further parameter settings (see chapter 5.2).
- Open the device in the **Offline** mode (see chapter 4.3.4).
- Click in the navigation window on **Settings**.

The parameter setting possibilities of the device are displayed in the function selection.

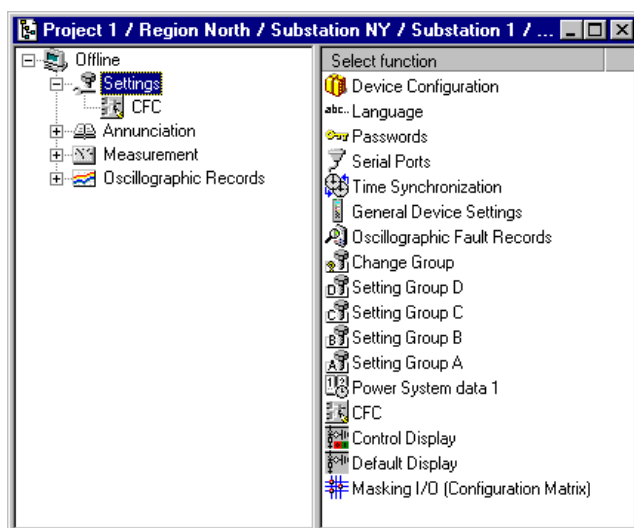

DIGSIB035

Fig. 5-1 Function selection, example

- Functional scope**
Specification of the functional scope of your device.
- Allocation**
Configuring device information by means of the device matrix and setting their properties.
- Default display**
Creating or changing the default display of your SIPROTEC 4 device with the **DIGSI 4 Display Editor**.
- Control display**
Creating or changing the control display of your SIPROTEC 4 device with the **DIGSI 4 Display Editor**.
- CFC**
Graphical configuration of the logic functions of your SIPROTEC 4 device with **DIGSI 4 CFC**.
- Measuring transducers**
Measuring transducer blocks
- Synchronization**
Synchronization blocks

- ❑ **Power system data**
System parameter settings independent of setting groups
- ❑ **Setting Group A to Setting Group D**
Settings for function parameters
- ❑ **Settings group change option**
Selection of one of the existing setting groups as the active setting group.
- ❑ **Fault recording**
Settings for configuring the fault recording.
- ❑ **Device**
Device parameter settings independent of setting groups
- ❑ **Time synchronization**
Settings for time synchronization
- ❑ **Interfaces**
Settings for port parameters in DIGSI 4 and in the device
- ❑ **Passwords**
Passwords for protecting against unauthorized access
- ❑ **Language**
Device operating language in the display of the operator control panel

**NOTE**

The availability of individual objects depends on the DIGSI 4 software used, the type of the SIPROTEC device, the set functional scope and the MLFB number specified in the DIGSI 4 Manager. For example, the Setting Groups B to D as well as the Change Group function are only available if Change Group was configured as **existing** when the functional scope was specified. The Language object is only displayed if a change in the device operating language is possible on the basis of the MLFB number.

5.2 Properties of a SIPROTEC 4 Device

When inserting a device into the project structure of the DIGSI 4 Manager you already specify important settings of the device, such as the type and version via the MLFB of the device. From the user interface of the DIGSI 4 Manager you can display and modify these **Object properties** of the device.

- Select a device in the data pane of the DIGSI 4 Manager and use the **Object properties** context menu to open the **Properties -SIPROTEC 4 device** dialog box.

The **Properties - SIPROTEC 4 device** dialog box contains the tabs:

- General**
General object properties
- MLFB**
The MLFB number identifies the type and version of the device
- Communications modules**
Settings for retro-fitted or exchanged communications modules and for communication on the basis of additional protocols, such as PROFIBUS DP, DNP 3.0 and MODBUS, as well as for a process bus link (device-specific)
- System management**
Information on supplementary device-specific properties and setting possibilities of the PC device language
- FMS / IEC setting**
Setting for communicating via the system interface per IEC or PROFIBUS FMS
- Inter Relay Communication**
Inter Relay Communication is limited to individual SIPROTEC 4 device types.



NOTE

If a full version of STEP 7 is installed on your computer, a further tab called **PROFIBUS FMS Connections** is displayed.

The properties of a **SIPROTEC 4 variant** are identical to those of the **SIPROTEC 4 device**.

5.2.1 MLFB Tab

You specify the order number MLFB of your SIPROTEC 4 device for DIGSI 4 in the **MLFB** tab. The type and version of the device are contained in encoded form in the order number.

The specification of an order number in DIGSI 4 influences the configuration possibilities. While a connection is being established between your DIGSI 4 PC and the SIPROTEC 4 device, the MLFB Number configured in the DIGSI 4 and the order number saved in the SIPROTEC 4 device are compared. Communication only takes place if the MLFB numbers are identical.

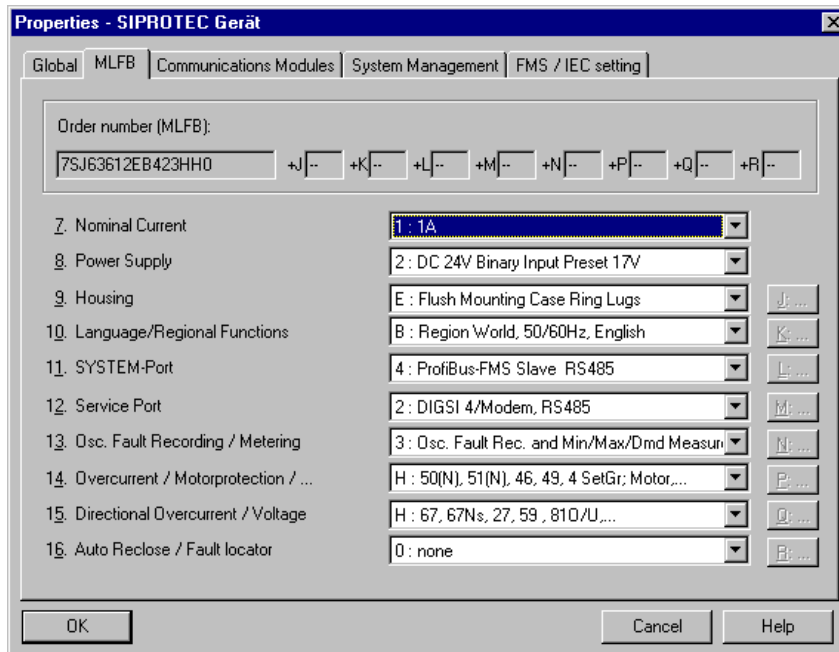

DIGSIMAN048

Fig. 5-2 Properties - SIPROTEC device, MLFB tab

Selecting the Order Number

- Select the data which correspond to the order number of your device from the drop-down list boxes. Only the drop-down list boxes relevant for the type of the SIPROTEC 4 device are active.

Some device types require additional input under certain points of the order number.

- Click the command button next to the drop-down list box and open the **MLFB-Extension** dialog box.

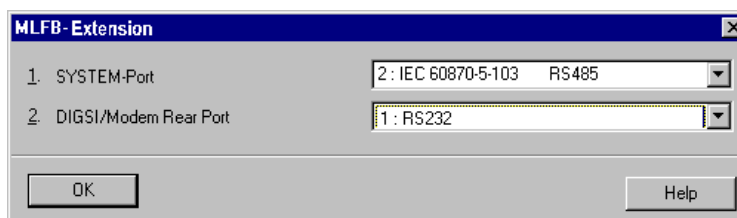

DIGSIMAN049

Fig. 5-3 MLFB-Extension dialog box

- Use the drop-down list boxes to select the settings and then click **OK** in order to return to the previous dialog box. Repeat this procedure with the further MLFB extensions.

5.2.2 Communications Modules Tab

The **Communications Modules** tab allows you to define settings for plug-in communications modules. If you have exchanged or retrofitted a communications module, inform DIGSI 4 of the change in this tab. Depending on the communications module you are using, you may have to change some more settings for the configuration (see chapter 7).

5.2.3 System Management Tab

The **System Management** tab is for displaying some device-specific properties. In addition, the PC device language is selected in this tab (see chapter 4.5.2).

5.2.4 Communications Modules Tab

The Communication Modules tab is for setting parameter values for communication via IEC 60870-5-103, IEC 61850, PROFIBUS FMS and channel switch. Only the parameters which are relevant for the currently selected system interface are visible. For further information on the communication settings please refer to chapter 7.

5.3 Specifying the Functional Scope of a SIPROTEC 4 Device

The maximum functional scope of a SIPROTEC 4 device is adapted to your system conditions in the **Device Configuration** dialog box of the DIGSI 4 Device Editor. In this process you specify whether you want to use a function and also carry out certain basic settings, for example the characteristics for an overcurrent stage. The configuration of the functional scope has an influence of the visibility and setting possibilities of further parameter settings and of the process data.



NOTE

For an overview of the relevant parameter setting values please refer to the device manual of your SIPROTEC device.



NOTE

The entry of the password for **parameter set** is required to change the configuration settings in the device. Without a password the settings can only be read.



NOTE

Certain devices do not have any option for entries in the **Device Configuration** dialog box.

Reading out the configured functional scope is also possible via the operator interface of the device itself. However, changes are not possible. You can access the settings of the functional scope via **MAIN MENU > Settings > Device Config**.

Proceed as follows in order to specify the functional scope:

- Open the device, click the **setting** and double-click in the function selection on **Device Configuration**. The **Device Configuration** dialog box is opened.

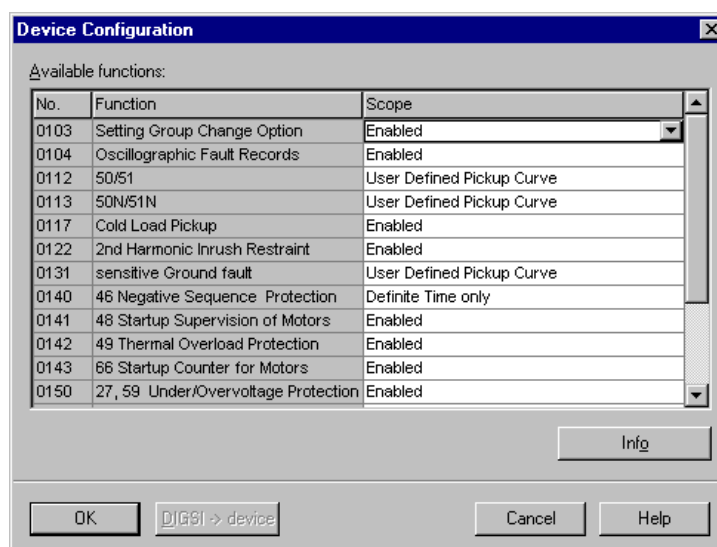

DIGSIB042

Fig. 5-4 Device Configuration dialog box

The **Device Configuration** dialog box lists all the functions which can be implemented along with their function numbers in table form. The current setting of a function is displayed in the **Scope** column.

Changing the Function Setting

- In order to change the current setting of a function, click in the corresponding field in the **Scope** column and select one of the settings offered from the drop-down list box.

Function-specific Information

- Select a function in the **Scope** column and click the **Info** command button. Further information on this function is then displayed.

Transferring Settings to the Device

- Click the **DIGSI > Device** command button to transfer the modified values to the SIPROTEC 4 device. The command button is active if you have changed at least one setting (see chapter 4.4).

Accepting Settings

- Click **OK** to accept your changes.
The command button is active only if you have changed at least one setting. The settings are **not yet** saved in the parameter set but only imported into the memory of your computer (see chapter 4.4).

5.4 Using Settings Groups

The parameter settings of some functions of your SIPROTEC 4 device are combined into settings groups. A SIPROTEC 4 device usually supports four settings groups independent of each other. These are identical in their functional scope and differ only in the setting values of the individual parameters. Some SIPROTEC 4 devices (e.g. 6MD63, 6MD66 and 6MD665) have no settings groups.

In order to use the settings groups, the **Change Group** function has to be set as **existing** in the functional scope. Some functions are independent of settings groups. These include for example CFC logic functions, synchronization functions or time synchronization. These functions are displayed as a separate object in the DIGSI 4 function selection.

Settings groups are used to save different function settings for various applications of your devices. All the settings groups are transferred to the memory of the SIPROTEC 4 device and can be changed over:

- Via operation
- Via binary input (event-driven) or
- By a message via the system interface.

Only one settings group is active at any time. The active settings group is displayed in the properties dialog box.

Proceed as follows:

- Open your device and click **Device > Operating State**. The **Operational Status** dialog box is opened.

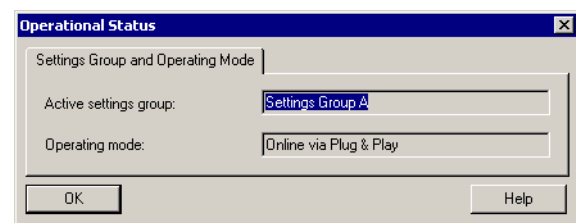

digs029.gif

Fig. 5-5 Operational status

- Double-click in the DIGSI 4 function selection on **Change Group**. The **Change Group** dialog box is displayed.

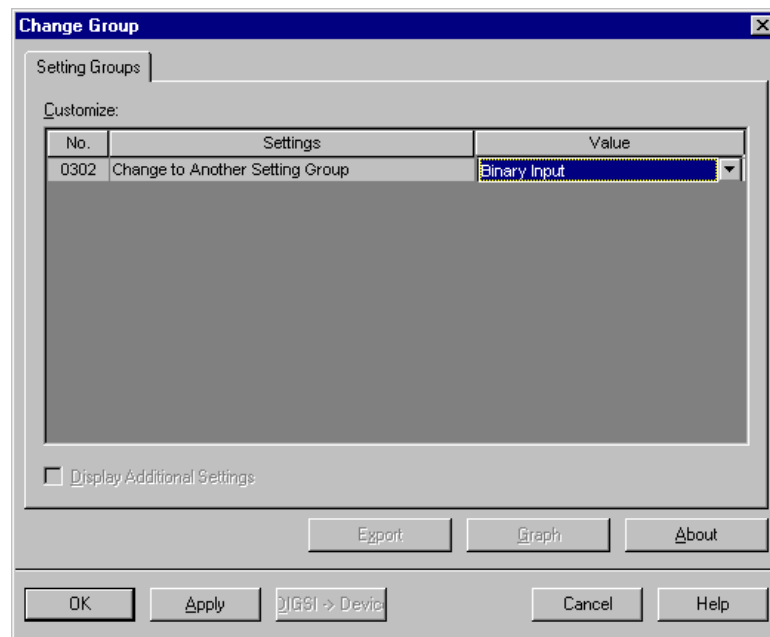

DIGSIGB044

Fig. 5-6 Settings group change option

- Use the drop-down list box to select one of the following as the setting value of the **Value** parameter:
 - ❑ One of the **Settings Groups A to D**
If you are working in the **Online** operating mode, use the **DIGSI > Device** command button to change over to the new settings group. Otherwise save your selection which is then activated when the parameter set is transferred to the device.
 - ❑ The setting **Binary Input**
The changeover of the settings group is triggered by an indication at a binary input. You specify in the device matrix which indication at which binary input causes the changeover.
 - ❑ The setting **Protocol**
The settings group changeover is then carried out message-controlled.

Copying a Settings Group

Proceed as follows in order to copy all the setting values of a settings group to another settings group:

- Click the settings group whose settings values are to be copied and drag-and-drop it onto the name of the settings group into which the settings values are to be copied.
- Confirm the confirmation query with **Yes**.



NOTE

All the setting values in the destination settings group are overwritten. However, the change is initially carried out in the temporary memory of the PC. If you have copied by mistake, close the device without saving and open it again. You will lose any other changes that you have not yet saved.

Resetting a Settings Group

When the functional scope of the device is specified, default values are assigned to the settings of a settings group. If you have changed the setting values, you can reset them to the original state by means of a menu command.

- Click the settings group and select **Reset** in the context menu or
- Select the settings group and click the **Reset** command button (see page 177).
- Confirm the confirmation query with **Yes**.

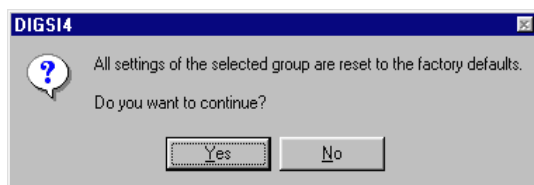

DIGSIGB046

Fig. 5-7 Confirmation query before a settings group is reset



NOTE

All the setting values in the selected settings group are reset. If you have reset by mistake, close the device without saving and open it again.

Editing Settings Groups

Proceed as follows in order to edit the parameter settings or a settings group:

- Double-click in the DIGSI 4 function selection on a **settings group (A to D)**. The **Setting Group x** dialog box is displayed with the overview of the available functions and their function numbers.

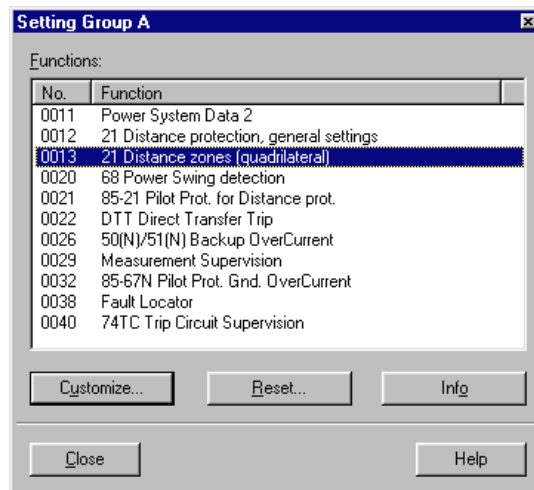

DIGSIGB130

Fig. 5-8 Settings group

- Click **Reset**. This resets the parameter settings to the default values which are entered automatically during the function selection.
- Select a function and click **Settings** in order to modify the parameter values. The dialog box for setting all the parameters belonging to this function is displayed. These are combined into several tabs depending on the type and number of the parameters.

Further information on editing the parameter settings of the settings group can be found in chapter 5.18, chapter 5.19 and chapter 5.20.

5.5 Allocating Information Items

5.5.1 Overview

The device matrix is a versatile tool for configuring and editing the information of a SIPROTEC 4 device. The term "information" includes the quantities used for the DIGSI 4 CFC logic functions in addition to the measured values, metered values, indications and commands of your device.

The device matrix can only be modified with DIGSI 4. You can have the configuration displayed, but not change it, on the display of your device.

Assigning Information

You can use the device matrix to assign information items to different components of the SIPROTEC 4 device, such as binary inputs, binary outputs, LEDs, buffers, displays, etc. Here you specify the assignment and the type of the assignment, for example an indication can be configured saved or unsaved to an LED. You link an item of information with a source and/or a destination. Configuring an information to a source means that an event causes this information. Configuring an item of information to a destination means that this information item is passed on or causes a reaction. Plausibility checks prevent meaningless configurations.

An overview of the configuration possibilities can be found in Appendix A.2. Which configuration can be carried out also depends on the type of your SIPROTEC 4 device and on the configured functional scope.

When the device is delivered information is already assigned to the LED's of the operator control panel, some function keys, the binary inputs and the binary outputs of the device. You can change these assignments for most of the items of information and adapt them to their local conditions.

Information Properties

Items of information have different properties, for example the dimension or the number of decimal digits in measured values. These information properties are selected via the device matrix and edited by means of dialog boxes.

Function Parameters

The device matrix furthermore enables access to the settings of various function parameters.



NOTE

If the configuration is changed afterwards, indications and statistical values of previous events can be lost. You should therefore back up the operating and fault indication buffer as well as the statistics counter (see chapter 6.2.7).

Configure

Proceed as follows to configure an information:

- Open the device, click **setting** and double-click in the function selection on **Configuration**. The configuration matrix is opened.
- Place the cursor on the cell that forms the intersection between the information line and source and destination column (the line and column are highlighted with a different color). If the cursor changes to a symbolic prohibition sign, it is not possible to route the information to the selected destination or selected source. If the cursor does not change its appearance, the information can be configured theoretically, meaning if no further rules are violated. For example, a maximum of 30 messages may be configured to a binary output.
- Right-click the cell. Different configuration types are offered in the context menu, depending on the type of information and the type of source or destination. Click on one of these configuration types. The configuration abbreviation is entered in the line. In all cases **_(not configured)** is offered. This deletes an existing configuration.

or

- Click the cell and enter the configuration abbreviation.
Confirm your entry by pressing the Return key or clicking another cell.
The abbreviation is checked for plausibility and commented with a error indication, if necessary. Confirm the indication with **OK** and correct your input.



NOTE

If you configure a command, all the other cells to the right of it will also be configured. If one of these configurations is canceled, all other cells are automatically set to not configured. The configured cells will be marked with Tr (= Off) and Cl (= On).

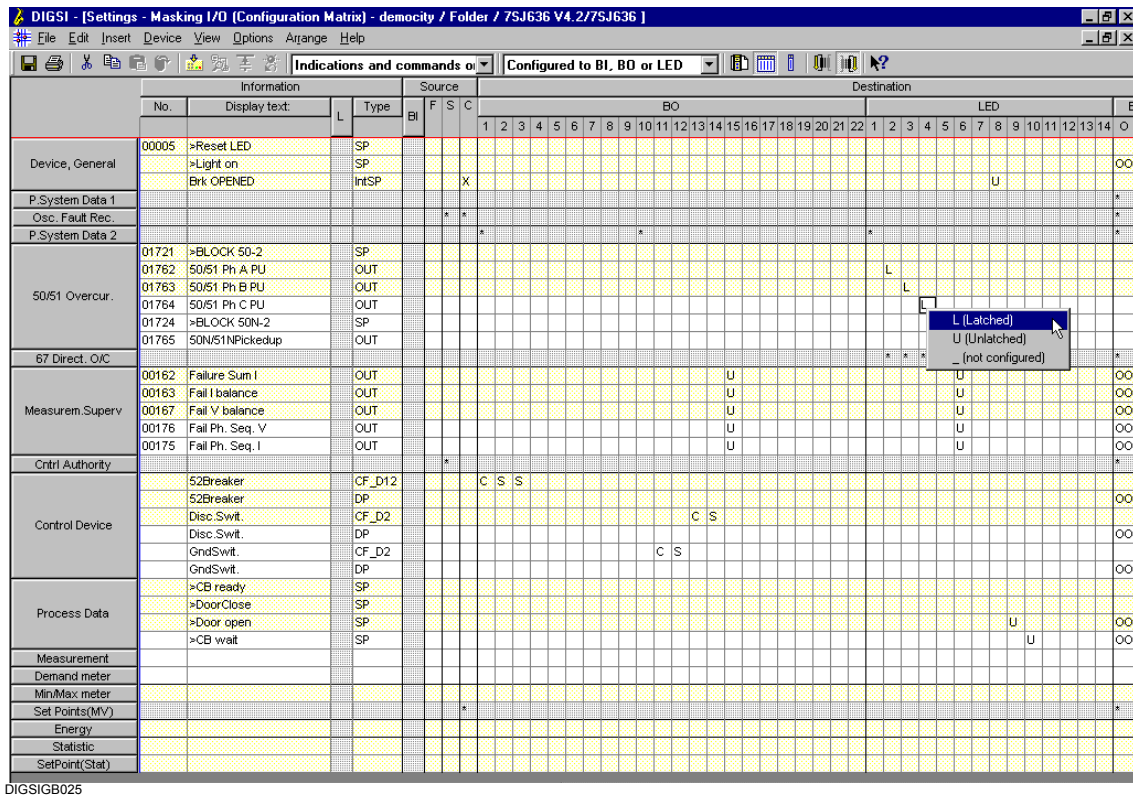

Fig. 5-9 Partial view of the device matrix

The columns and rows of the matrix are combined by functions into blocks. The designations of these blocks are designed as command buttons by means of which you can carry out various operations to change the matrix view.

The interconnection between the source and the destination of an information is visualized by a tagging in the intersection of line and columns. The type of tagging is specified context-sensitively and depends on the type of information, source and destination.

How to delete configurations column by column

You can delete all (deletable) configurations from a column (e.g. binary inputs BI) simultaneously.

- To do this, right-click the corresponding column. This displays a context menu which contains a command of type **Delete configurations at binary inputs** depending on the selected column.
- Click on this command.
If the selected column does not contain any deletable configurations, a corresponding message will be displayed. Otherwise, a confirmation query appears, asking you whether you really want to delete the configurations of the selected column, and showing the number of configurations to be deleted.
- Please note that the currently hidden configurations will also be deleted.

Horizontal Structure

The device matrix is structured horizontally into the areas **Information**, **Source** and **Destination**. Depending on its type an information can have different sources and destination. An overview of the configuration possibilities can be found in Appendix A.2.



NOTE

The scope of the displayed sources and destinations depends on the device type, on the specified functional scope and on the set information view. For example, columns for analog inputs are only available if the SIPROTEC 4 device has the corresponding inputs and if these were configured in the functional scope. These columns are only visible in the measuring- and metered-value view.

Information

Items of information are data which are to be configured, for example indications or commands. An item of information consists of several individual specifications.

- Number**
For identifying the information and its description in the device documentation.
- Display text**
Information text for display on the display unit of a SIPROTEC 4 device
- Long text**
Detailed description of the information
- Type**
Detailed specification of the information, for example **BR_D2** double command with feedback

Source

The source designates the origin of an information which the device receives for further processing. Sources are:

- Binary input BI**
Optocoupler input for entering binary process indications. The number of binary inputs is device-specific.
- Analog input**
Transducer input for detecting analog process signals for voltage and current. The number of voltage and current values is device-specific.
- Function key**
For linking the operation of a function key on the operator control panel of the SIPROTEC 4 device to the issuing of an input indication, for example the initiation of a switching operation.
- CFC**
Result of a user-defined **DIGSI 4 CFC** logic function.
- System interface**
Information from a control center via the system interface.
Inter Relay Communication
Inter Relay Communication is the exchange of information between SIPROTEC 4 devices. Information items of other devices which are involved with an IRC combination can be the source of additional information items.

Destination

The destination specifies to which component an information is forwarded. Destinations are:

- ❑ **Binary output**
Relay for outputting a binary signal. The number of binary outputs is device-specific.
- ❑ **LED**
Destination of various indication types. The number of LED's is device-specific.
- ❑ **System interface**
Information to a control center via the system interface.
- ❑ **CFC**
Input information for further processing by **DIGSI 4 CFC**.
- ❑ **Control display**
Information which is to be displayed graphically or in text on the control display.
- ❑ **Default display**
Information which is to be displayed graphically or in text on the default display.
- ❑ **Control CO**
Control objects and taggings are listed in the on-site operation unit at the display under the **Control** menu item.
- ❑ **Buffer**
Indications which are to be saved in the SIPROTEC 4 device in the operational indication buffer, ground fault indication buffer, network fault buffer or warning buffer.
- ❑ **Inter Relay Communication**
Inter Relay Communication is the exchange of information between SIPROTEC 4 devices. Information items can be applied for use on another device involved with a IRC combination. In this case the IRC combination is the target for information items.

Vertical Structure

Information items are combined into function-oriented groups vertically. The groups existing by default can be extended by user-defined information or supplemented by user-defined groups. However, it is not possible to delete these groups or to change their name (see chapter 5.7).



NOTE

The extent of the information displayed depends on the device type and the specified functional scope.

Coloring

The device matrix is divided horizontally into yellow and white blocks. This sub-division is used exclusively for better orientation and has no influence on the configuration possibilities.

A range of hidden columns or lines is indicated by a grayed column or line.

If you try to enter an illegal configuration, the cell also turns gray.

5.5.2 Configuring Information to Binary Inputs (Source)

The following types of information can be configured to binary inputs (BI):

- Single point indication
- Double point indication
- Bit pattern indication
- Transformer tap indication
- Pulse metered value

Conditions

It is not possible to configure individual items of information to several binary inputs. For example, if a single point indication is configured to a binary input, this configuration is removed as soon as you configure the identical single point indication to another binary input.

You also cannot configure an indication to a binary input if this is already configured to the CFC as source. If you attempt to do so, an error message is displayed.

Configuring a Single Point Indication

Select one of the following options:

- H (active with voltage)**
The indication is created if a signal is applied to the binary input.
- L (active without voltage)**
The indication is created when no signal is applied to the binary input.
- _ (not configured)**
The indication is not linked with the binary input.

Configuring Double Point Indications

Select one of the following options:

- X (configured)**
The indication is created if a signal is applied to the binary input.
- _ (not configured)**
The indication is not linked with the binary input.

If you route a double point indication to a binary input, the next-highest binary input is also configured. If one of these configurations is canceled, the other binary input is also automatically set to **not configured**. Configuration to the last binary input is not possible, since it would then not be possible to link a second binary input.

The sequence of the binary input channels has a fixed definition. The OFF indication always lies before the ON indication.

Configuring a Bit Pattern Indication

Select one of the following options:

- X (configured)**
The indication is created if a signal is applied to the configured binary input.
- _ (not configured)**
The indication is not linked to the binary inputs.

If you configure a bit pattern indication to a binary input, further next-higher binary inputs are also configured. The total number of binary inputs configured is identical to the number of bits configured for the bit pattern indication. The first bit has to be configured so that there are still sufficient binary inputs available for the other bits. Otherwise, an error indication is displayed. If you cancel this configuration, all the other binary inputs are automatically set to **not configured**. If you change the number of bits in the properties dialog box of configured bit pattern indication, the configuration is adapted automatically.

Configuring a Transformer Tap Indication

Select one of the following options:

- X (configured)**
The indication is created if a signal is applied to the binary input.
- _ (not configured)**
The indication is not linked with the binary input.

If you configure a transformer tap indication to a binary input, further next-higher binary inputs are also configured. The total number of binary inputs configured is identical to the number of bits configured for transformer tap indications. If you cancel one of these configurations, all the other binary inputs are automatically set to **not configured**.

Configuring Pulse Metered Values

Select one of the following options:

- X (configured)**
The pulse metered value is incremented if a pulse is applied at the binary input.
- _ (not configured)**
The pulse metered value is not linked to the binary input.

5.5.3 Configuring Information to Analog Inputs (Source)

Only the information type **measured value channel** can be configured to an analog input (U or I) as the source. For example, a measured value channel can correspond to the input of a measuring transducer block.

Conditions

A voltage measured value channel can only be configured to a voltage input. Similarly a current measured value channel can only be configured to a current input.

Multiple configuration of an item of information of the type **measured value channel** to analog inputs is not possible. If a measured value channel is already configured, this configuration is removed as soon as you configure the identical measured value channel to another analog input.

Configuring a Measured Value Channel

Select one of the following options:

- X (configured)**
The function block contains a current or voltage value if a signal is applied to the analog input.
- _ (not configured)**
The measured value channel is not linked to the analog input.

5.5.4 Configuring Information to Function Keys (Source)

It is possible to configure internal single point indications to four different function keys (F).

A function key can already be assigned because it has already been configured for the selection of a function. Thus, for example, when a device is delivered, F1 is assigned by default to display the operational indications, F2 to display the primary operational measured values and F3 to select the overview of the last fault indications.

Conditions

Your SIPROTEC 4 device has to be equipped with function keys. Each function key can only be linked to one internal indication (IE or tagging). If you attempt to configure an internal indication to a function key which is already assigned, an error indication is displayed.

Configuring an Internal Indication

Select one of the following options:

- 1 (Function Key 1) to 4 (Function Key 4)**
The indication is generated as soon as the function key interconnected to it is pressed on the SIPROTEC 4 device.
- _ (not configured)**
The indication is not interconnected to the function key.



NOTE

If the function key is already configured (see Chapter 6.5.5), an error indication is displayed.

5.5.5 Configuring Information to Binary Outputs (Destination)

The following types of information can be configured to binary outputs (BO):

- Single point indication
- Output indication
- Value indication
- Internal single point indication
- External single point indication
- Command

Conditions

A maximum of 30 indications and commands can be configured to one binary output. Similarly, one indication can be configured to a maximum of ten binary outputs and LEDs.

Configuring Indications

Select one of the following options:

- L (Latched)**
The indication is configured to the selected binary output in a latched mode. The corresponding relay picks up as soon as the indication exists and remains picked up until the relay is reset at the device. This is effected by the LED Reset button being pressed on the front panel of the device, via a binary input with the signaling function **> LED Reset** or via the system interface.
This function is used, for example, to signal that there is an indication which has not been acknowledged yet. To this purpose you create a general indication via CFC and then configure it to an LED.
- U (Unlatched)**
The indication is configured unlatched to the selected binary output. The relay in question picks up as soon as the indication is applied. It drops out as soon as the indication is no longer applied.
- _ (not configured)**
The indication is not configured to the binary output.

Configuring Commands

Select one of the following options:

- X (configured)**
The command is configured to the binary output.
- I (Info)**
This binary output is specified as the signal relay. The signal relay is activated as long as the command is being output, irrespective of the switching direction. You can route several commands to the same signal relay and link this relay to checking equipment, for example.
- C (Central common contact)**
The binary output is defined as the common contact. You can assign a common binary output as the root for several 1-pole double controls, thus saving binary outputs. A precondition is that the signals at the common contact outputs have the same potential. Example: Common ground potential.
- _ (not configured)**
The command is not configured to the binary output.



NOTE

If you configure a command to a binary output, all the other binary outputs to the right of it that are required are also configured. If one of these routings is canceled, all other binary outputs are automatically also set to **not configured**. The outputs will be marked with Tr (= Off) and Cl (= On).

Rapid Binary Outputs

Depending on the variant ordered, some binary outputs have an operating time abbreviated by approx. 3 ms. They are therefore particularly suitable for outputting trip commands of the protection function and for controlling the send devices at protection functions with signal transfer. Further information can be found in the device manual.

Binary Outputs for Switching Devices

One particular point has to be observed when configuring the binary outputs for switching devices. The command type (for example single or double command, with or without feedback) is specified for the switching devices of the system and a corresponding command type is configured to the binary outputs in the matrix. If the required command type is not contained in the matrix, insert a suitable one from the information catalog into the matrix.

5.5.6 Configuring Information to LEDs (Destination)

The following types of information can be configured to LEDs (LE):

- Single point indication
- Output indication
- Internal single point indication
- External single point indication
- Value indication

Conditions

No more than ten indications can be routed to one LED. Similarly, one indication can only be routed to up to ten LEDs and command outputs.

Configuring Information Items

Select one of the following options for all of the information types stated above:

- L (Latched)**
The indication is configured to the selected LED in a latched mode. The corresponding LED lights up as soon as the indication is applied and extinguishes when it is reset at the operator control panel of the device.
- U (Unlatched)**
The indication is routed to the selected LED in a unlatched mode. The LED in question lights up as soon as the indication is applied. It goes out as soon as the indication is no longer applied.
- _ (not configured)**
The indication is not configured to the LED.

5.5.7 Configuring Information to System Interface (Source)

The following information types can be configured to the system interface (S) as the source:

- Output indication (for factory-predefined configuration only Read Only)
- Internal single point indication
- Internal double point indication
- Command with and without feedback (for IEC and other protocols with restrictions for info type transformer tab)
- External command with and without feedback
- Limit (only PROFIBUS FMS and supplementary protocols)
- User-defined limit (only PROFIBUS FMS and supplementary protocols)

For particularities of the configuration for IEC 61850 refer to the table in Section A.2.1.

Configuring Information Items

Select one of the following options for all of the information types stated above:

- X (configured)**
The information comes via the system interface to the SIPROTEC device.
- _ (not configured)**
The information item is not configured to the system interface.



NOTE

If the current SIPROTEC 4 device is connected to a SICAM station, you must perform SICAM export again if you have made changes to configurations in the system interface.



NOTE on IEC 61850

For the IEC 61850 protocol, you can only configure user-defined information to the system interface (S). For GOOSE communication, you have to use external messages; for the info report, the other message types named above are permissible, as in other protocols.

As soon as you have configured such an item of information, you have to assign it to an IEC 61850 object. All factory-configured information is Read Only! In the System Configurator help, the complete way from creating a project to the configuration of IEC 61850 objects is shown on one example.



NOTE on 7SJ686

The 7SJ686 device can include up to 3 system interfaces (port B, C, D), depending on the version. Correspondingly, the configuration matrix provides up to 3 columns for the routing - one column for each port - as source for the system interfaces (S).

5.5.8 Configuring Information to the System Interface (Destination)

The following information types can be configured to the system interface (S) as the destination:

- Single point indication
- Double point indication
- Output indication
- Value indication
- Internal single point indication
- Internal double point indication
- External single point indication
- External double indication
- Bit pattern indication (only PROFIBUS FMS)
- External bit pattern indication (only PROFIBUS FMS)
- Transformer tap indication (only PROFIBUS FMS)
- Limit value (Read Only for IEC 60870-5-103)
- User-defined limit value (Read Only for IEC 60870-5-103)
- Measured value (Read Only for IEC 60870-5-103)
- Measured value with time (Read Only for IEC 60870-5-103)
- User-defined measured value (Read Only for IEC 60870-5-103)
- Pulse metered value
- Metered value calculated from measured value
- External metered value

Read only means that the configuration for this type of information is displayed but cannot be changed.

For particularities of the configuration for IEC 61850 refer to the table in Section A.2.1.

Configuring Information Items

Select one of the following options for all of the information types stated above:

- X (configured)**
The information is passed on to connected components via the system interface.
- _ (not configured)**
The information item is not configured to the system interface.



NOTE

If the current SIPROTEC 4 device is connected to a SICAM station, you must perform SICAM export again if you have made changes to configurations in the system interface.

**NOTE on IEC 61850**

For the IEC 61850 protocol, you can only configure user-defined information to the system interface (S). For GOOSE communication, you have to use external messages; for the info report, the other message types named above are permissible, as in other protocols.

As soon as you have configured such an item of information, you have to assign it to an IEC 61850 object. All factory-configured information is Read Only! In the System Configurator help, the complete way from creating a project to the configuration of IEC 61850 objects is shown on one example.

**NOTE on 7SJ686**

The 7SJ686 device can include up to 3 system interfaces (port B, C, D), depending on the version. Correspondingly, the configuration matrix provides up to 3 columns for the routing - one column for each port - as destination for the system interfaces (S).

If the SIPROTEC 4 device is equipped with an interface for transferring data in accordance IEC 60870-5-103 and if an IEC address was specified, you have to carry out further settings as soon as you configure a command, an indication or a metered value to the system interface.

You have to carry out settings for the following parameters:

□ Function type

Within the IEC 60870-5-103 protocol, a function type identifies the functionality of a SIPROTEC 4 device. For example, there are function types for a distance protection unit or a machine protection unit. Please refer to the documentation of the specified protocol for information on which number corresponds to which device type. Some numbers are not assigned. These can be freely used without impairing the IEC compatibility.

□ Information number

An information number has to be assigned for each selected function type. This information number describes the type of information (command, indication or metered value) that is to be transmitted via the system interface. The assignment between the number and the information is also to be found in the documentation of the specified protocol.

□ DU type

The DU type is only relevant to indications. You specify the basic type of indication. The settings **Operational indication** and **Fault indication** are available for selection.

The settings are carried out in the **Object Properties - IEC 60870-5-103** dialog box.

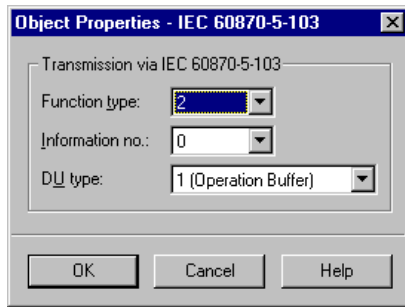

DIGSIB099

Fig. 5-10 **Object Properties - IEC 60870-5-103** dialog box

Carrying Out Settings

- Select a function type, an information number and, in the case of indications, a DU type from the drop-down list boxes.

Accepting Settings

- Click **OK** in order to accept your settings into the temporary memory of your PC.

5.5.9 Configuring Information to the Default Display and Control Display (Destination)

You can configure the following types of information separately to the default display and control display (D, C):

- Single point indication
- Double point indication
- Output indication
- Internal single point indication
- Internal double point indication
- External single point indication
- External double point indication
- Transformer tap indication
- Command with and without feedback
- External command with and without feedback
- Measured value
- Measured value with time
- Measured value user-defined
- Pulse metered value
- Metered value calculated from measured value
- External counter

Configuring Information Items

Select one of the following options for all of the information types stated above:

- X (configured)**
The information can be used in the control display and/or default display.
- _ (not configured)**
The information cannot be used in the control display and/or default display.

5.5.10 Configuring Information to the Buffer (Destination)

The following types of information can be configured to buffers (B):

- Single point indication
- Double point indication
- Output indication
- Value indication
- Internal single point indication
- Internal double point indication
- Transformer tap indication
- Bit pattern indication
- External single point indication
- External double point indication
- External bit pattern indication
- Command without feedback

Up to four buffers are available for selection: Operational indication buffer (O), Ground fault indication buffer (G), Warning buffer (W) and Network fault buffer (N). Please refer to Appendix A.2 for information on which message type can be configured to which buffer. Please refer to the device manual for information on which buffers are available.

Configuring Information Items

Select one of the following options for all of the types of indication stated above:

- O (ON)**
The indication is stored in the selected buffer with the time of occurrence. This type of configuration is not available for warning buffers.
- OO (ON/OFF)**
The indication is stored in the selected buffer at the time it occurs and is cleared. This type of configuration is not available for warning buffers.
- X (configured)**
The indication is stored in the selected buffer with the time of occurrence. This type of configuration is only available for warning buffers.
- _ (not configured)**
The indication is not configured to a buffer.

5.5.11 Configuring Information to Measured Value Windows (Destination)

The following types of information can be configured to measured value windows:

- Limit value (Read Only)
- Limit value user-defined (Read Only)
- User-defined measured value

Read only means that the configuration for this type of information is displayed but cannot be changed.

Configuring Information Items

Select one of the following options for all of the information types stated above:

- X (configured)**
The information is displayed in a measured value window.
- _ (not configured)**
The information item is not displayed in a measured value window.

In addition to the measured values made available by the device you can configure user-defined measured values and limits in the measured value window. These are then available on the device display in the assigned measured value window.

5.5.12 Configuring Information to Metered Value Window (Destination)

The following types of information can be configured to metered value windows:

- Pulse metered value
- Metered value calculated from measured value

Configuring Information Items

Select one of the following options for all of the information types stated above:

- X (configured)**
The information is displayed in a metered value window.
- _ (not configured)**
The information item is not displayed in a metered value window.

5.5.13 Configuring Information to Control (Destination)

The following types of information can be configured to control (CO):

- Single point indication (only SI, not SI_F)
- Double point indication
- Transformer tap indication
- Internal single point indication
- Internal double point indication
- External single point indication (only ExSI, not ExSI_F)
- External double point indication
- Bit pattern indication
- External bit pattern indication
- Command with and without feedback
- External command with and without feedback

Configuring Single Point, Double Point and Transformer Tap Indications

Select one of the following options:

- X (configured)**
The actual state of the information item is displayed in DIGSI 4 Gerätebearbeitung in the **Device** dialog box as well as in the SIPROTEC 4 device. The actual state can be updated on the SIPROTEC 4 device.
- _ (not configured)**
There is no access to the actual state of the information item.

Configuring Internal Single Point and Double Point Indication

Select one of the following options:

- X (configured)**
The actual state of the information item is displayed in DIGSI 4 Gerätebearbeitung in the **Tagging** dialog box as well as in the SIPROTEC 4 device. The actual state can be set using the specified dialog box and on the SIPROTEC 4 device.
- _ (not configured)**
There is no access to the actual state of the information item.

Configuring Commands

Select one of the following options:

- X (configured)**
The actual state of the information item is displayed in DIGSI 4 Gerätebearbeitung in the **Equipment** dialog box as well as in the SIPROTEC 4 device. The actual state can be changed using the Equipment dialog box and on the SIPROTEC 4 device.
- _ (not configured)**
There is no access to the actual state of the information item.

Configuring a Bit Pattern Indication

Select one of the following options:

- X (configured)**
The indication is created if a signal is applied to the configured binary input.
- _ (not configured)**
The indication is not linked to the binary inputs.

If you route a bit pattern indication to a binary input, the next binary inputs up are also routed. The total number of binary inputs configured is identical to the number of bits configured for the bit pattern indication. The first bit has to be configured so that there are still sufficient binary inputs available for the other bits. Otherwise, an error indication is displayed. If you cancel this configuration, all the other binary inputs are automatically set to **not configured**. If you change the number of bits in the properties dialog box of an configured bit pattern indication, the configuration is adapted automatically.

5.5.14 Configuring Information to the CFC (Destination)

Function

If you want to use items of information as **input quantities** of **DIGSI 4 CFC** logic functions, you have to configure these items of information in the device matrix to **CFC (destination)**. You can then interconnect these items of information as input quantities in CFC on the **left-hand margin** to the inputs of the logic blocks. This method allows you for example to interconnect currents to the corresponding limits and initiate the changeover of the settings groups by means of the logic function. The current and the limits are configured in the process as a CFC source, while the "Change Group" result is configured as a destination.

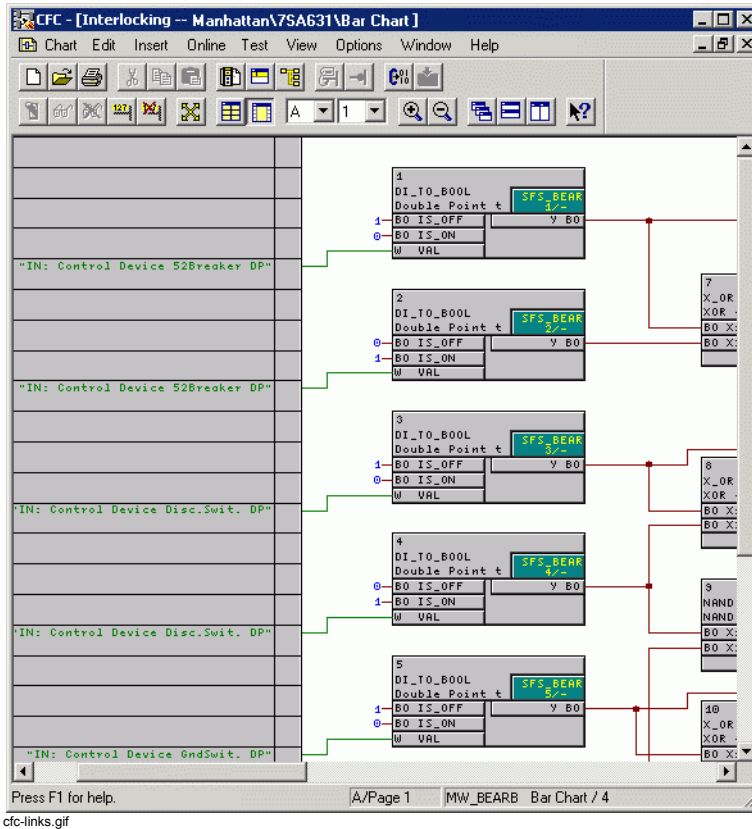

Fig. 5-11 CFC configuration, interconnection of the input quantities, example

For information on graphic configuration please refer to the *DIGSI CFC, Manual /2/*.

The following types of information can be configured to the CFC (C) as the destination:

- Single point indication
- Double point indication
- Output indication
- Value indication (from firmware version 4.5)
- Internal single point indication
- Internal double point indication
- Command
- External command
- Limit value
- User-defined limit value
- Measured value
- User-defined measured value
- Pulse metered value
- Metered value calculated from measured value
- External metered value

Configuring Information Items

Select one of the following options for all of the information types stated above:

- X (configured)**
The information can be used as the input quantity of a logic function.
- _ (not configured)**
The information cannot be linked to a logic function.

5.5.15 Configuring Information to CFC (Source)

Function

If you want to process the **result** of a **DIGSI 4 CFC** logic function further, you have to configure the corresponding information to **CFC (source)**. You can then interconnect the outputs of the CFC logic blocks on the **right-hand margin** to these items of information.

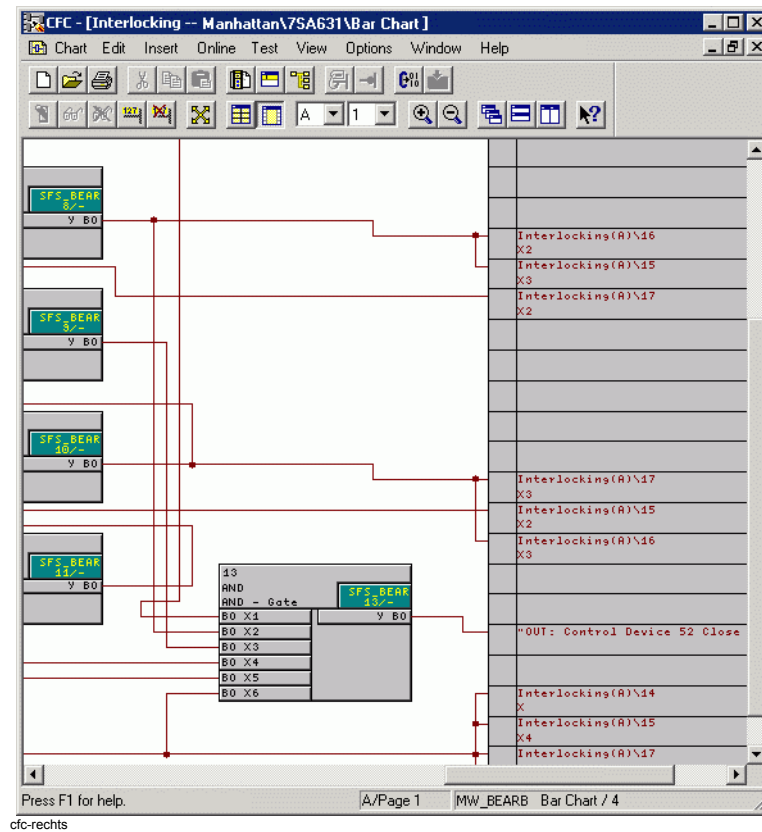

Fig. 5-12 CFC configuration, interconnection of the output quantities, example

The following types of information can be configured to the CFC (C) as the source:

- Single point indication
- Double point indication
- Output indication
- Value indication (from firmware version 4.5)
- Internal single point indication
- Internal double point indication
- Command
- External command
- User-defined measured value
- Limit value
- User-defined limit value
- External metered value

**NOTE**

You cannot configure an indication to CFC if this is already configured to a binary input as a source. If you attempt to do so, an error message is displayed.

Configuring Information Items

Select one of the following options for all of the information types stated above:

- X (configured)**
The information item can be generated by a corresponding result of a logic operation.
- _ (not configured)**
The information cannot be linked to a logic function.

5.6 Displaying Information

5.6.1 Filtering

Filters can be used to limit the display of the information of an extensive matrix to the section which you require for the current configuration of your data.

The toolbar contains two drop-down list boxes for specifying the **filter criteria**.

By Information Type

- Select one of the following options from the left-hand drop-down list box of the toolbar:

- Only indications and commands**
- Only indications**
- Only commands**
- Only measured and metered values**

As long as you are filtering information items by a certain type of information, it is not possible to display information items of other types. If a group with information items of the type of filter currently selected was hidden before the filter was set, you can display it again.

The choice of information filter also affects the device matrix in the horizontal direction.

Depending on the type of information selected, specific sources and destinations are added for this type or sources and destinations that are not required are hidden completely.

By Configuration Type

A further possibility of limiting the displayed scope of data is to filter according to configuration type.

- Select one of the following options from the right-hand drop-down list box of the toolbar

- Configured to BI, BO, or LED**
Only the information items that are configured to **at least** one binary input, binary output, or LED are displayed. Information items that are configured to **additional** sources or targets are also displayed.
- Configured information items**
Only those information items that are configured to **at least** one source or target are displayed.
- Non-configured information items**
Only those information items that are configured neither to a source nor a destination are displayed.
- No filter**

All information items that do not match the filter criterion are hidden completely. If a group was hidden which contained information for which the selected criterion applied before the filter was set, it can be displayed again.

5.6.2 Displaying / Hiding Lines or Columns

A further filter possibility is to minimize an information group to one line.

- Double-click on the group designation in order to hide the information. The line is grayed out.
- Double-click again in order to display all the individual items of information.

In order to limit the width of the matrix you can:

- ❑ Change over between **Standard** and **Short View** in the toolbar or via the **View** menu bar. This changes all the columns in the Source and Destination groups. The columns of the Information group are not affected.
- ❑ Display and hide individual columns.

Proceed as follows in order to display and hide columns:

- Double-click the command button of a column header. The columns are reduced to a common column. In order to display all the columns again, double-click once again on the column header.

Inside each cell of a common column, abbreviations inform you about the type of configuration of an information item. The abbreviation **R5** in a cell of the common column **BI**, for example, means that the information item in question is configured to the open-circuit contact of the binary input **5**. If an information item is configured to several destinations, the abbreviations of all destinations are displayed separated by commas. In order to view all the abbreviations, double-click the respective cell. You can alternately move the text cursor horizontally inside the cell.



NOTE

The **View** menu alternatively offers various commands for changing the displayed areas of the device matrix.

5.7 Inserting and Deleting Information

Information Types

The scope of information displayed in the device matrix is determined by the device type and the specified functional scope. If required, this scope of information can be extended by user-defined information.

The options for allocating information are described in Chapter A.2.

Indications

Information type	Abbreviation	Description	Default value, FS/RS ¹⁾	From firmware during startup	Status ²⁾
Single-point indication	SI	Information on the process status (e.g., ON/OFF) at a binary input, see Chapter B.1	-	0	n
Single-point indication fleeting	SI_F	Information on a briefly pending signal at a binary input ^{3), 4)}	-	-	n
Double-point indication	DP	Information on the process statuses (e.g., ON/OFF, intermediate position) at 2 binary inputs, see Chapter B.1	-	0	n
Double-point indication intermediate position	DP_I	Information on an intermediate position at 2 binary inputs	-	0	n
Output indication	OUT	Information which can be output via a binary output, an LED, or the serial interface	-	0	-
Output indication fleeting	OI_F	Brief signal which can be output via a binary output ^{3), 5)}	-	0	a
Transformer tap indication	TxTap	Information on a transformer tap position at one or several binary input(s)	-	-	a
Value indication	VI	Single-point indication in which an value is transferred in addition to the actual information	-	-	a
Internal single-point indication	IS	Single-point indication of an internal status, e.g. operating state of the system	-	-	a
Internal single-point indication fleeting	IS_F	Single-point indication fleeting of an internal status ³⁾	-	-	a

Information type	Abbreviation	Description	Default value, FS/RS ¹⁾	From firmware during startup	Status ²⁾
Internal double-point indication	ID	Double-point indication of an internal status	-	-	a
Internal double-point indication intermediate position	ID_S	Double-point indication intermediate position of an internal status	-	-	a
External single-point indication	ExSI	Single-point indication of the Ethernet connection	1, 2/ 0, 1, 2	0	n
External single-point indication fleeting	ExSI_F	Single-point indication fleeting of the Ethernet connection ³⁾	1, 2/ 0, 1, 2	-	-
External double-point indication	ExDP	Double-point indication of the Ethernet connection	1, 2/ 0, 1, 2, 3	-	-
External double-point indication intermediate position	ExDP_I	Double-point indication intermediate position of the Ethernet connection	1, 2/ 0, 1, 2, 3	-	-
Bit pattern indication 8 bits, 16 bits, 32 bits	BM8, BM16, BM32	Information on the statuses of 8, 16, or 32 linked binary inputs	-	0	n
External bit pattern indication 8 bits, 16 bits, 32 bits	ExBM8, ExBM16, ExBM32	Bit pattern indication 8 bits, 16 bits, 32 bits of the Ethernet connection	xx/ 0, xx	0	a
External counter	ExMV	Counter value via the Ethernet connection ⁶⁾	-	-	-

¹⁾ FS = first startup, RS = restart

²⁾ a = active, n = not active

³⁾ Fleeting indications cannot be sent via GOOSE or IEC 61850 since these do not provide this functionality. Usually, these indications have been converted to coming/going indications by the firmware.

⁴⁾ This indication is defined as coming indication, regardless of whether it is a binary input.

⁵⁾ This indication is only defined as coming indication.

⁶⁾ Do not use this indication.

Commands without/with feedback

Information type	Abbreviation	Description
Single command	C_S CF_S	Information which issues a control signal for a switching device at a binary output, see Chapter B.2
Single command negated	C_SN CF_SN	Information which issues a negated control signal for a switching device at a binary output
Double command 1-pole (2 BO)	C_D2 CF_D2	Information which issues the control signals for a switching device at 2 binary outputs, see Chapter B.2
Double command 1-pole OFF/ 2-pole ON (3 BO)	C_D12 CF_D12	Information which issues the control signals for a switching device at 3 binary outputs, see Chapter B.2
Double command 1.5-pole (3 BO)	C_D3 CF_D3	Information which issues the control signals for a switching device at 3 binary outputs, see Chapter B.2
Double command 2-pole (4 BO)	C_D4 CF_D4	Information which issues the control signals for a switching device at 4 binary outputs, see Chapter B.2
Double command 1-pole negated (2 BO)	C_D2N CF_D2N	Information which issues the negated control signals for a switching device at 2 binary outputs
External single/double command	ExC ExCS	Single/double command via the Ethernet connection
Single command 2-pole (2 BO)	C_S2 CF_S2	Information which issues the control signals for a switching device at 2 binary outputs.
Double command 2-pole ON/ 1-pole OFF (3 BO)	C_D21 CF_D21	Information which issues the control signals for a switching device at 3 binary outputs
Double command 2-pole ON/ 2-pole OFF (4 BO)	C_D22 CF_D22	Information which issues the control signals for a switching device at 4 binary outputs
Double command 3-pole OFF/ 1-pole ON (4 BO)	C_D31 CF_D31	Information which issues the control signals for a switching device at 4 binary outputs
Double command 3-pole OFF/ 3-pole ON (6 BO)	C_D33 CF_D33	Information which issues the control signals for a switching device at 6 binary outputs
Double command 4-pole OFF/ 4-pole ON (8 BO)	C_D44 CF_D44	Information which issues the control signals for a switching device at 8 binary outputs

Measured values

Information type	Abbreviation	Description
Limit measured value user-defined	LVU	Measured value with additional information on falling below/ exceeding a user-defined value
Limit measured value	LV	Measured value with additional information on falling below/ exceeding a defined value
Measured value channel	MC	Information on a value at an analog input
Protective measured value	MV	Information on the current value during the shutdown procedure of a switching device
Protective measured value with time	MVT	Information on the current value during the shutdown procedure of a switching device, stating the relative time
Protective measured value user-defined	MVU	Information on the current value during the shutdown procedure of a switching device, user-defined

Metered values

Information type	Abbreviation	Description
Pulse metered value	PMV	Information on the number of pulses at a binary input
Metered value calculated from measured value	MVMV	Information on metered values calculated from measured values, e.g., energy metered values

**NOTE**

Output indications correspond to protective indications, internal indications to taggings.

5.7.1 Inserting Information into a Group

Information items are inserted into an existing group using the information catalog. Proceed as follows:

- In order to open the information catalog select **Insert > Information** or **View > Information catalog**.

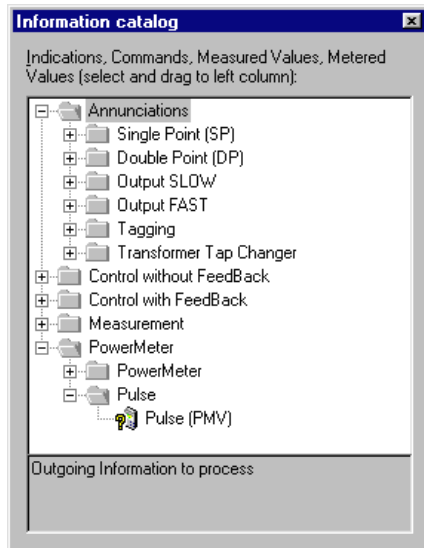

DIGSIGB064

Fig. 5-13 Information catalog

Structure of the Information Catalog

The information catalog is structured into the information types

- Indications**
- Commands without feedback**
- Commands with feedback**
- Measured values**
- Metered values**

These levels then contain the information types, for example **single point indication, double point indication or output indication**.

Inserting an Item of Information

- Open the corresponding folders until you access the individual item of information. Select the designation of an item of information. Hold down the left mouse button and drag the name out of the information catalog onto a group button on the left-hand side of the device matrix and release the mouse. The line for the information is inserted into the group. The abbreviation of the information text is assigned by default to the display text, the text in the information catalog to the long text.

**NOTE**

When an item of information of the type **Command with feedback** is inserted, one line is inserted for the actual command and one line for the associated feedback.

5.7.2 Inserting an Information Group

In order to individually extend the scope of information available by default you have the possibility of defining user-defined groups in which you can then insert your user-defined information.

These groups and the items of information can be deleted at any time.

Proceed as follows:

- Click the command button of a group before or after which a new group is to be inserted and select **Insert Group - Before** or **Insert Group - After** in the context menu. The **Insert Group** dialog box is opened.

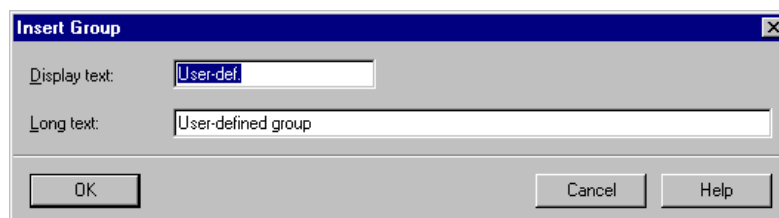

DIGSIGB063

Fig. 5-14 Inserting a group

- In the **Display text** box enter a designation with a maximum length of 15 characters for the labeling of the group command button.
- In the **Long text** box enter a designation with a maximum length of 30 characters as the text for the tooltip. This is displayed when the cursor is positioned on the group designation.
- Click **OK** to apply your settings.

The settings are not yet saved in the parameter set but only imported into the memory of your computer. For information on saving the settings please refer to chapter 4.4.



NOTE

New groups can only be inserted in the vertical structure of the device matrix.

5.7.3 Renaming Groups and Information

Proceed as follows in order to rename user-defined groups and items of information:

Renaming a Group

- Click the command button of the group which you want to rename and select **Rename Group** in the context menu.
The **Group Properties** dialog box is opened.

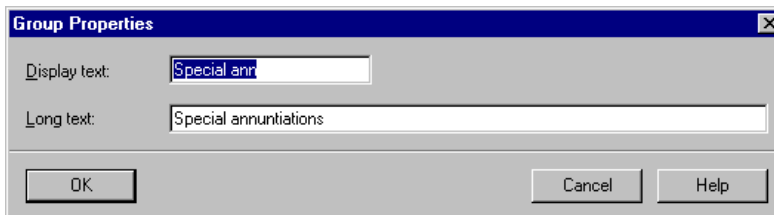

DIGSIB065

Fig. 5-15 Group properties

- Change the display (short) and long text and click **OK**. The dialog box is closed and the group name is updated.

Renaming Information

To change the name of an item of information:

- Double-click on the cell, change the designations and press **Return**.

5.7.4 Deleting Groups and Information

Proceed as follows in order to delete user-defined groups and items of information:

- Click the command button of the group which you want to delete and select **Delete Group in the context menu**.
- Confirm the confirmation query with **Yes**.

The group is deleted.



NOTE

When you delete a group, all the information items contained in it are lost. It is not possible to undo this operation directly. If you have deleted by mistake, close the device without saving and open it again. You will lose any other changes that you have not yet saved.

Deleting Information

Click the cell of the information which is to be deleted, select **Delete Information** and respond to the confirmation query with **Yes**.

5.8 Properties of Items of Information

Each item of information has information-type-specific properties which can be set individually for each individual item of information. You can, for example, specify for each indication whether it is to be displayed as a tagging in the fault recording, or you define for internal individual indications the state which it is to have when the device is started up. The information properties are protocol-specific, meaning that not all the functions of all the protocols are supported.

Editing Property Values

Proceed as follows in order to edit the property values:

- Click in the **Information** column block on the cell of the information and select **Properties** in the context menu.
The **Object properties** dialog box is opened.

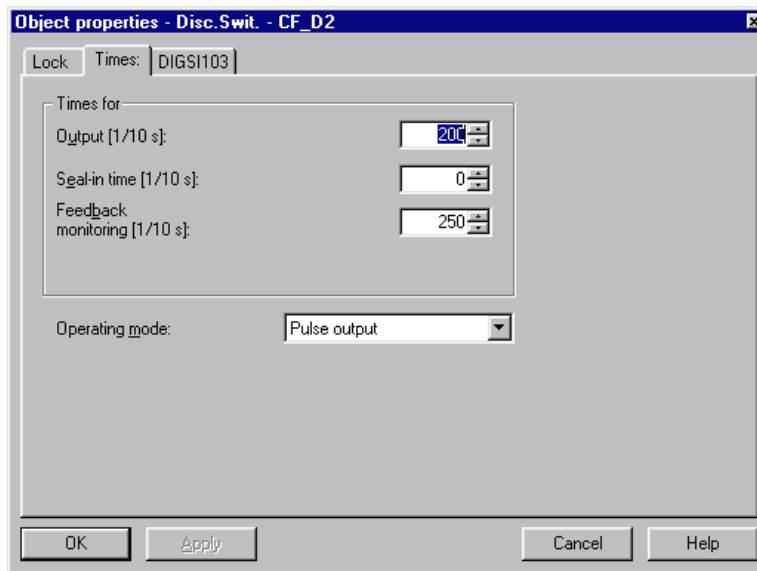

DIGSIB148

Fig. 5-16 Object properties, example

Structure of the Dialog Box

The short text (display text) specified for the selected information and the abbreviation for the type of information are displayed in the title bar.

The property values which can be set are combined into tabs. The type and number of the tabs are determined by:

- The type of the SIPROTEC 4 device
- The information type
- The parameter set version.

Accepting Property Values

- Click **OK** in order to accept property values and close the dialog box.
- Click **Apply** in order to edit the property values in further tabs.

In either case, the values are placed in the memory of the computer. The values are **not yet** stored in the parameter set (see chapter 4.4).

5.8.1 Default Selection

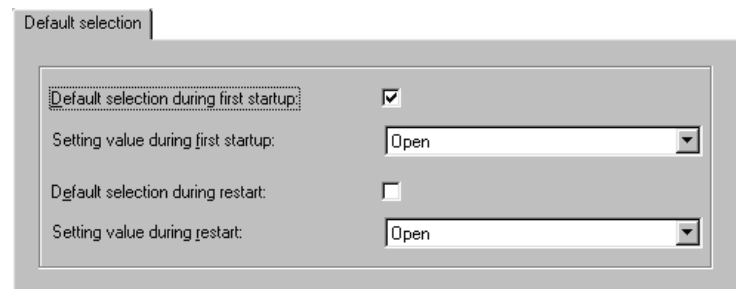

DIGSIB139

Fig. 5-17 Example of Default selection tab

- Select the **Default selection during first startup** check box to activate the **Setting value during first startup** box.
- Select a value which is to be assigned to the information during a first startup from the **Setting value during first startup** drop-down list box. On some devices you have to enter a defined value directly.
- Select the **Default selection during restart** check box to activate the **Setting value during restart** box.
- Select a value which is to be assigned to the information during a restart from the **Setting value during restart** drop-down list box. On some devices you have to enter a defined value directly.



NOTE

Information on the restart and resume can be found in chapter 4.3.6.

5.8.2 Marking in the Fault Record

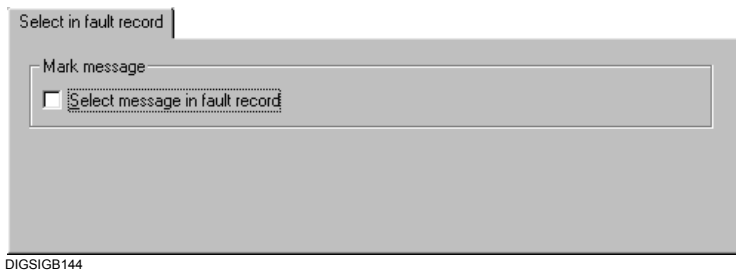

DIGSIGB144

Fig. 5-18 Example of the Select in fault record tab

- Select the **Select message in fault record** check box to enable the indication to be logged in the fault record. This check box can be selected for a maximum of 40 indications (in some cases, the parameter set of your SIPROTEC device may define another maximum value).

5.8.3 Chatter Blocking and Filter

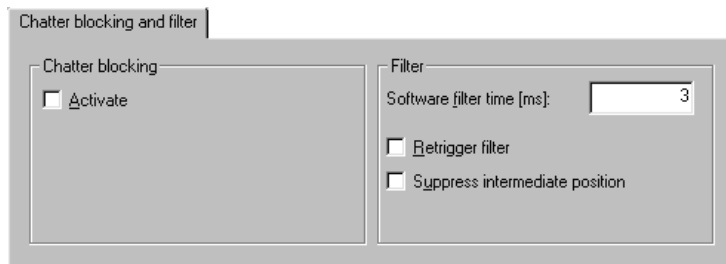

DIGSIGB140

Fig. 5-19 Example of Chatter blocking and filter tab

- Select the **Activate chatter blocking** check box to activate the chatter blocking for this indication. For certain indications this check box is de-activated in the factory settings.
- Enter the length of the filter time in milliseconds in the **Software filter time** box. The filter time indicates how long a signal must be pending to be interpreted as an indication. Value range **0** to **86400000 ms** (equal to 1 day).
- Select the **Retrigger filter** check box to restart the filter time after the signal has ceased and then been applied again. This check box is active as soon as you have entered a permissible value in the software filter time.
- Activate the **Indication filter time** option in order to create the indication at the time of the first indication change. The **Retrigger filter** check box is activated simultaneously. If the option is not activated, the indication is created after the filter time has expired.
- Select the **Suppress intermediate position** in order to suppress the indication during an intermediate position.

5.8.4 Transformer Taps

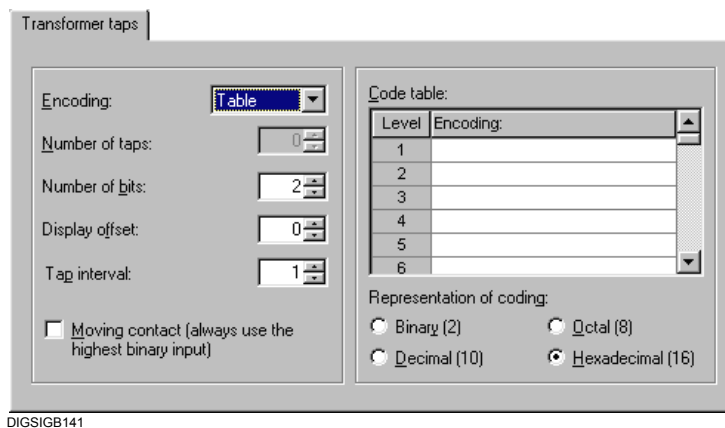

DIGSGB141

Fig. 5-20 Example of Transformer taps tab

- Select the type of the interpretation of the indications pending at the binary inputs in the **Encoding** drop-down list box, alternatively **Binary**, **1 of n**, **BCD** or **Table**. Select **Table** if you want to specify an individual encoding.
- Set the number of transformer taps in the **Number of taps** spin box.
- Set the number of bits that are required to encode the transformer taps in the **Number of bits** spin box. The number depends on the code you have selected. For example, you require three bits for eight transformer positions that are coded in binary. An existing configuration may limit the number of bits that can be set.
- Enter the value by which the height of the displayed value is to be offset in the positive or negative direction compared to the height of the actual value in the **Display offset** box. The value range is -127 to +127.
- Set the number of intervals in the field Tap interval for switching mechanisms with intervals. The intervals can be set on the switching mechanism manually. The Tap interval is the number of intervals in which the bay device switches up or down (range 1...8).
Example:
Tap interval = 2: 2 steps with 0,5 intervals
Tap interval = 4: 4 steps with 0,25 intervals
- Select the numerical system in which your entries are to be carried out in the coding table in the **Representation of coding** section. These are alternatively **Binary (2)**, **Octal (8)**, **Decimal (10)** and **Hexadecimal (16)**. The selected option applies to all the entries in the **Encoding** column. If you change the numerical system when entries already exist in this column, these entries are converted to the new numerical system.
The selection area is displayed as soon as you have selected the **Table** setting in the **Encoding** box.
- Enter the encoding of the tap value in the **Encoding** column of the **Code table**. The entered value must lie within the decimal range 0 to 256 and entered in accordance with the previously selected number system. The number of encoded tap values is determined automatically. Click **Apply**, to enter the number in the **Number of taps** box.
The selection area is displayed as soon as you have selected the **Table** setting in the **Encoding** box.

**NOTE**

If all binary inputs used for coding are inactive, an invalid tap setting is displayed (not considering the display offset). The display shows _____ for an invalid tap setting.

- Activate the **Moving contact** option if the tap setting is not to be recognized as valid and applied until the moving contact signals that the taps have been reached.

Example

Four transformer tap settings with the designations 3 to 6 are to be represented by means of three binary inputs (BI 1 to BI 3). Encoding is binary.

Control			Desired representation
BI 1	BI 2	BI 3	
-	-	-	63.00
X	-	-	3.00
-	X	-	4.00
X	X	-	5.00
-	-	X	6.00
X	-	X	63.00

A maximum of $2^3 = 8$ tap settings can be represented by means of 3 binary inputs in binary code. The representation of the transformer taps is to begin with the metered value 3. The information properties have to be configured as follows for the example:

Encoding	Binary
Number of tap positions	4
Number of bits	3
Display offset	2
Tap interval	1

The 3 binary inputs have to have consecutive numbers without gaps, for example BI 1, BI 2 and BI 3.

5.8.5 Pulse Type and Error Input

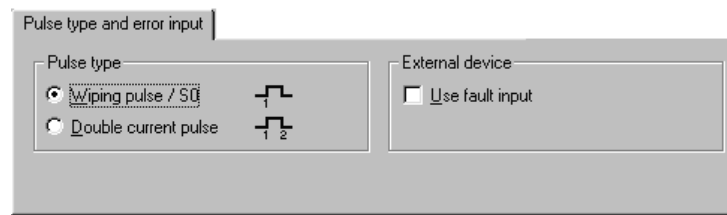

DIGSIGB143

Fig. 5-21 Example of Pulse type and error input tab

- Select the **Wiping pulse / S0** option in the **Pulse type** section if the rising edge of a single pulse is to increment the metered value by one. Select the **Double current pulse** option if both the rising and falling edge of a double current pulse is to increment the metered value by one.
- Select the **Use fault input** check box if you want to configure a pulse metered value to a binary input and evaluate the signal at the assigned fault input.

5.8.6 Restore Trigger and Energy Flow Direction

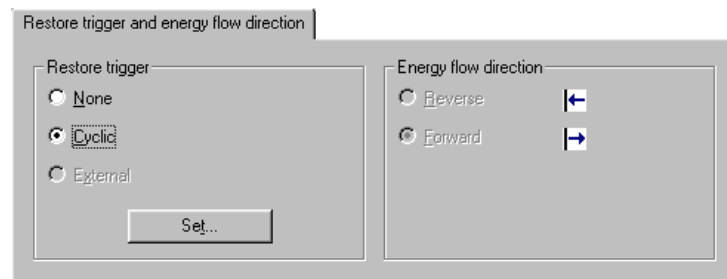

DIGSIGB142

Fig. 5-22 Example of Restore trigger and energy flow direction tab

- Select the **Cyclic** option in the **Restore trigger** section if the metered value is to be transmitted to the control center at cyclic intervals. Otherwise select the **None** option.
- Click on **Set**, in order to carry out global settings for restoring all the metered values.
- Specify in the **Energy flow direction** section whether the metered value summates the quantity of exported or imported energy. These options are only active for user-defined metered values.

5.8.7 Measured Value Description

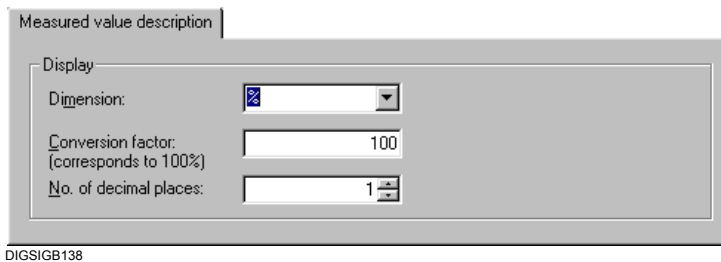

DIGSIGB138

Fig. 5-23 Example of **Measured value description** tab

- Select the dimension from the **Dimension** drop-down list box or enter it directly. The measured value is displayed with this dimension in the measured value window. A change in the dimension is only possible in case of user-defined measured values and limits.
- Enter the value with which the input signal is converted to the selected dimension in the **Conversion factor** box. The conversion always relates to the input signal for measured values and to the corresponding measured value for limits. A change in the conversion factor is only possible in case of user-defined measured values and limits.
- Select the number of decimal places for the display in the measured value window from the **No. of decimal places** spin box. You can select between zero and ten decimal places. A change in the number of decimal places is only possible for user-defined measured values.

5.8.8 Bit Pattern



DIGSIGB145

Fig. 5-24 Example of Bit pattern tab

- Set the bit width of the bit pattern indication in the **Number of bits** spin box. 8 bits, 16 bits and 32 bits can be selected. The maximum number that can be set may be restricted by the configuring position of the first bit for a bit pattern indication that is already configured.

5.8.9 Lock

Lock

System locking and zone control

Check system locking

Check zone control

Release ON command: No device interlock signal

Release OFF command: No device interlock signal

Release when system locking AND Zone control completed

Release when system locking OR zone control completed

Further lockings

Blocking for protection activation

Double operation

Check switching authority at ...

Local commands (device display)

Remote commands (system interface, DIGSI)

Unclearable lock

Device status (nominal = actual)

Password: Switchgear password 3

Release ON command: Device, General Device OK

Release OFF command: Device, General Initial Start

DIGSIGB147

Fig. 5-25 Example of Lock tab

Zone control

- Select the **Check zone control** check box if the presence of a zone control is to be checked before the command output. A zone control exists if a release condition prescribed for the ON or OFF command is not complied with. Such a release condition is selected via the corresponding **Release ON command** or **Release OFF command** drop-down list box. If this is the case, a release is not usually possible. If you have selected the **Release when system locking OR zone control completed** option, a command is released although there is a zone control.
- Select one indication each as the command release condition for each command in the **Release ON and OFF commands** boxes. In order to execute a command in a switching direction without release condition, select the **None** setting from the corresponding drop-down list box. The display texts of all the indications defined in the device matrix are offered for selection. The fields are activated as soon as the **Check zone control** check box is selected.

System interlocking

- Activate the **Check system locking** check box to cause the central device for checking for a system lock before outputting a command. In this case the command is not released. If you have selected the **Release when system locking OR zone control completed** option, a command is released although there is a system locking.

**NOTE**

System interlocking is only possible with a connection via PROFIBUS FMS to a station control system.

- Select the **Release when system locking AND zone control completed** option so that the command is only released if there is neither a system locking nor a zone control.
- Select the **Release when system locking OR zone control completed** option so that the command is also released even if there is either a system locking or a zone control. These options can only be selected for SIPROTEC 4 devices V4.2 or higher. They are only activated if the **Check zone control** and **Check system locking** check boxes are selected.

Further Lockings

- Select the **Blocking for protection activation** check box if the presence of a protection activation is to be checked before the command output. A protection block exists if a protection device has responded due to a network fault and tripped. The command is then not output. OPEN-commands can always be executed. Please be aware that an activation of thermal overload protection elements or of the sensitive ground fault protection can create and maintain a fault condition status, and can therefore block CLOSE commands. If the interlocking is removed, consider that, on the other hand, the restart inhibit for motors will not automatically reject a CLOSE command to the motor. A re-closing on then has to be interlocked by other means, for example, by means of the bay interlocking via CFC.
- Select the **Double operation** check box if a check is to be carried out whether the command has already been output before it is output again. The command is then not output.
- Select the **Double operation** check box to check prior to command output if a command is already being processed for other switching devices for which the double operation blocking has also been set (1-of-N check). If that is the case, the command is not output.

**NOTE**

Double operation of one and the same switching device is always denied.

- Activate the **Check switching authority at local commands** check box to ensure that the system checks, before the output of a local command at the SIPROTEC 4 device, if the switching authority is set to **Local**. Only then is the command output.
- Activate the **Check switching authority at remote commands** check box to ensure that the system checks, before the output of a remote command at the SIPROTEC 4 device, if the switching authority is set to **Remote**. Only then is the command output.

Unclearable Lock

The lock conditions previously described can be de-activated prior to a switching operation. To do this you need to select the **Bypass interlock** check box in the **Equipment** dialog box. After a password prompt, the switching operation is executed irrespective of the lock conditions. However, this does not apply to lock conditions that you have specified in the **Unclearable locks** area. These are taken into account even if the **Bypass interlock** check box is selected.

- Select the **Device status (nominal = actual)** check box if a check is to be carried out whether the nominal state of the device already corresponds to the actual state before the command is output. The command is then not output. The device status is checked for interlocked and non-interlocked switching.
- Select one of the ten possible switchgear passwords from the **Password** drop-down list box. The password is prompted before every command output. The individual switchgear passwords can be changed (see chapter 4.6).
- Select one indication each as the command release condition for each command in the **Release ON and OFF commands** boxes. In order to execute a command in a switching direction without release condition, select the **None** setting from the corresponding drop-down list box. The display texts of all the indications defined in the device matrix are offered for selection.

5.8.10 Times

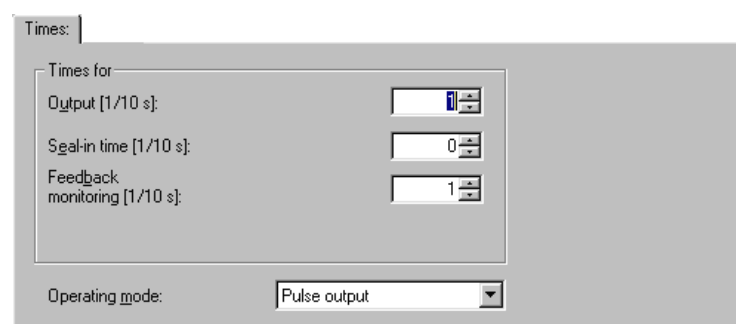

DIGSIGB137

Fig. 5-26 Example of Times tab

- If you have selected **Pulse output** as the operating mode, enter the pulse duration in tenths of a second in the **Output** box and select the seal-in time in tenths of a second in the **Seal-in time** box. The output time is extended by this time if the setpoint switch position has not yet been reached although the feedback has already been received. The seal-in time is relevant for such items of equipment that output a feedback before the switch operation has been completed.
- Set the period for feedback monitoring in tenths of a second in the **Feedback monitoring** spin box. The command feedback has to arrive within this period. If the feedback arrives after the feedback monitoring period has elapsed, it is stored as a spontaneous indication.
- If you have selected **Pulse output** as the operating mode, enter the delay in tenths of a second in the **Command end delay** box. The delay time starts as soon as the output time has elapsed. The delay time is used to co-ordinate sequences of commands since the command cannot be output once more during this period.
- Specify the signal shape of the command in the **Mode** drop-down list box. You can choose between **Persistent output** and **Pulse output**. If several commands are configured to a binary output, the operating mode of the commands has to be identical.

Time response of the command output

The **command output** function works in sampling intervals of 100 ms.

It is triggered immediately after the command has been initiated and checked. All additional processing and monitoring actions are time-controlled.

The parameters for monitoring times (e.g. output time, feedback monitoring time, etc.) are guaranteed minimum times, i.e. the actual monitoring times/run times can vary between + 0 and + 99 ms:

Monitoring times/run times = parameter + (0 ... 99 ms)

Since the integrated control operates with the same 100-ms sampling interval as the command output, + 99 ms always applies to commands with the source **Local Control** (VQ_LOCAL).

Example:

Parameter command output time = 5.0 s dependent on the command source:

Command source	Output time
Local control (integrated operator control)	= 5099 ms
all other command sources	= 5000...5099 ms

5.8.11 Transmission Threshold

The transmission threshold determines the transmission frequency of measured values. It is specified in percent. If zero is selected as the threshold value of the transmission threshold, each measured value is transmitted to the higher-level station. A threshold value not equal to zero has the effect that the changes with regard to measured values are added to the last transmitted measured value. If the sum of the changes reaches the set percentage value, the new measured value is transmitted at the earliest possible opportunity.

The **Transmission threshold** tab is displayed if the measured value is configured to the system interface as the destination.

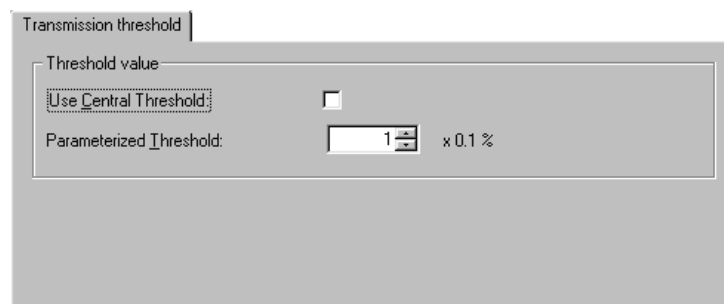

DIGSIB146

Fig. 5-27 Example of **Transmission threshold** tab

Threshold Value

- To use the factory-preset threshold value, check the **Use central threshold**. This deactivates all the other input and selection options in this tab.
- Set a value between 0 and 2000 in the **Parameterized Threshold** spin box. The set value multiplied by 0.1% results in the threshold value. This value is used without any further conditions, provided that neither the **Central threshold** check box, nor a defined switching object, has been selected.

Changeover

The state of an indication can effect a changeover between the factory-preset threshold value and the parameterized threshold value. The states **ON** or **INCOMING** activate the parameterized threshold value. The states **OFF** or **OUTGOING** activate the factory-preset threshold value.

- Select the name of the indication whose state is to effect a changeover in the **Switching over** drop-down list box.
The long texts of the indications defined within the **Switching Object** group are displayed.
If only the factory-preset threshold value or only the parameterized threshold value is to be used, select the setting **No threshold switching**.

5.8.12 IEC 103 (IEC 60870-5-103)

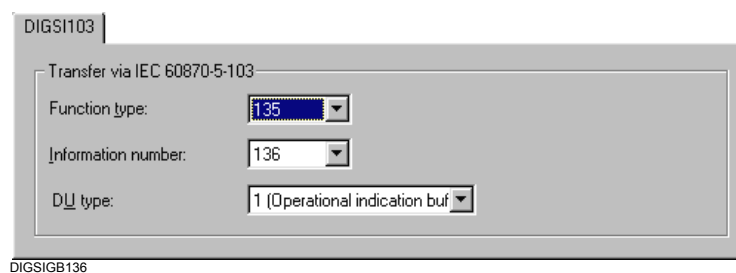
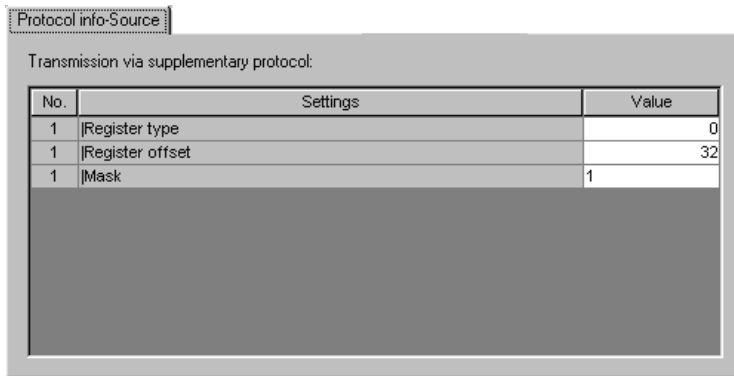

Fig. 5-28 Example of IEC 103 tab

- Enter the number of the function type of your SIPROTEC 4 device in the **Function type** box which identifies the functionality of the device, for example distance protection unit. The number is contained in the documentation of the specified protocol. Some numbers are not assigned. These can be used freely without impairing the IEC compatibility.
- Select the **Operational indication** or **Fault indication** settings in the **DU type** box.
- Enter the number of the selected function type in the **Information number** box. This information number describes the type of information (command, indication or metered value) that is to be transmitted via the system interface. The assignment between the number and the information can also be found in the documentation of the specified protocol.

5.8.13 Protocol Info



DIGSIB154

Fig. 5-29 Example of Protocol info - Source tab

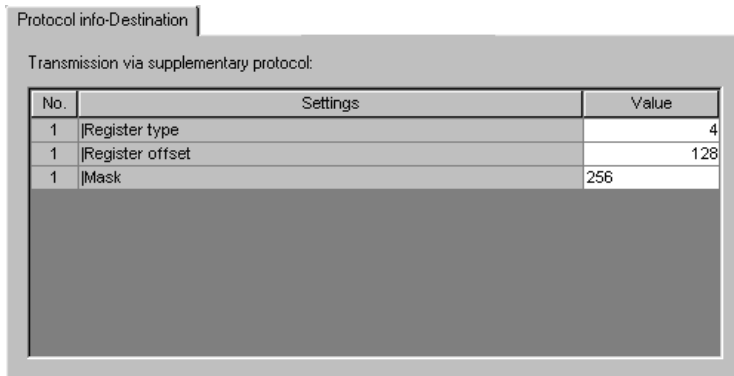

DIGSIB155

Fig. 5-30 Example of Protocol info - Destination tab

These tabs are only of significance in connection with other protocols. Depending on whether the information is configured to a system interface as a source or destination, one or both of the tabs is displayed. The parameters in the **Protocol info - Destination** or **Protocol info - Source** tabs that can be defined by the user depend on the protocol.

You will receive protocol documentation together with the communication module. This documentation describes the meaning of the individual parameters.

5.8.14 Measured Value - Destination

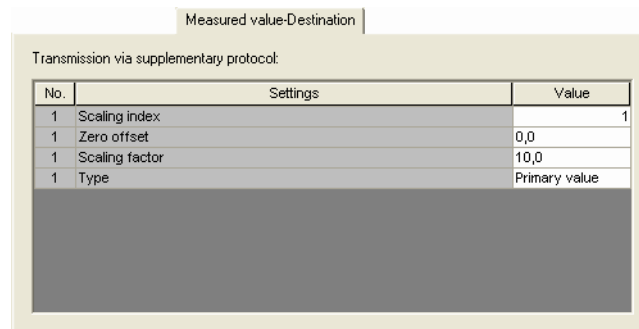

No.	Settings	Value
1	Scaling index	1
1	Zero offset	0,0
1	Scaling factor	10,0
1	Type	Primary value

digsigb153.tif

Fig. 5-31 Example of Measured value - Destination tab

This tab is only of significance in connection with other protocols (PROFIBUS DP, DNP 3.00 and MODBUS). It serves to scale the measured values. The scaling of a measured value is usually necessary if the resolution of a measured value needs to be reduced. For example, the reduction of a 32-bit measured value to 16 bits may result in the loss of information that is of particular significance to the measured value in question. By scaling the measured value, you can counteract this effect.

- Select the appropriate index in the **Scaling index** line.
Each **Scaling index** is assigned values of the parameters **Zero offset**, **Scaling factor** and **Type**. The assigned values are different for the various device types and protocols.

The value of the **Zero offset** parameter is added to the measured value.

The value of the **Scaling factor** parameter is multiplied with the measured value.

With the **Type** parameter, the type of the measured value (percentage value, primary value or secondary value) is defined.



NOTE

The values of the parameters **Zero offset** and **Scaling factor** can be changed. Any change also affects all other measured values with the same **Scaling index**. In the case of a change, a warning message is issued.

The **Type** parameter cannot be changed.

You may be able to edit other settings depending on the protocol you are using, for example **Threshold value** for the protocol **DNP 3.00**.

5.8.15 Fast indications

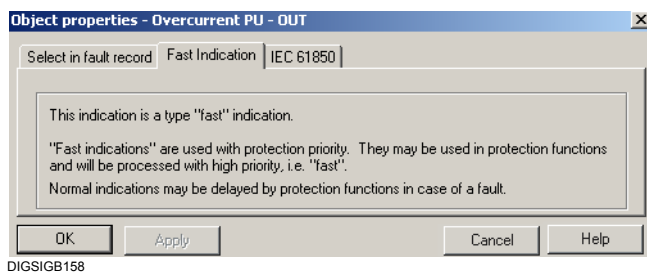

DIGSIGB158

Fig. 5-32 Fast indications tab

This tab informs you about the type of an indication:

- "Fast indications" have protection priority. They can enter protection applications and are processed with high priority (quickly).
- Other indications may be delayed by the protection system in the event of a fault.

5.9 Configuring the Metered Value Restoring Function

Transmission of metered values from the memory of a SIPROTEC 4 device to the control center is called freezing. Freezing of metered values is performed cyclically. You define on what time base you want freezing to be triggered cyclically. You also define the time interval and decide whether the metered value buffers are to be reset after freezing or not.



NOTE

All the settings made apply globally to all metered values.

Proceed as follows:

- Select **Options > Metered Values**. The **Restore Metered Values** dialog box is opened.

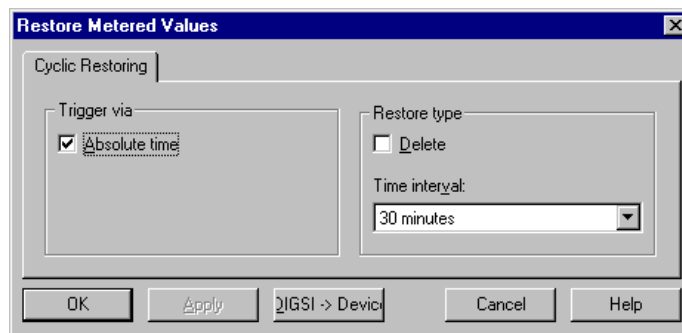

DIGSIGB081

Fig. 5-33 Restoring metered values

- If triggering is to be performed at the set time intervals on the absolute time base, select the **Triggering with absolute time** check box. If this check box is not selected, triggering is performed on a relative time base.
- Select the time interval for freezing metered values from the **Time interval** drop-down list box.
- Select the **Delete** check box if you want the metered value buffer to be deleted after the metered values have been frozen.
- Click the **DIGSI > Device** command button in order to transfer the values to the device. The command button is only active if you are working in the **Online** operating mode and if at least one value was changed.
- Click **OK** to apply your entries. The changes are only saved in the computer memory, **not** in files.

5.10 Configuring Chatter Blocking

For binary information from the system, the chatter blocking checks whether the number of state changes of an indication input exceeds a specified number within a configurable period. If this happens, the indication input is to be blocked for a certain period so that the event list does not contain a large number of unnecessary entries.

If chattering occurs at a binary input and if this input is then blocked, this fact is identified in the corresponding indication by the supplement **FLS**. In addition, the **Chatter blocking** indication is displayed in the operational indication buffer.

A chattering single point indication is set to **ON** during operation in an open-circuit system.

A chattering single point indication is set to **OFF** during operation in a closed-circuit system.

The indication can be included in an interlocking in CFC.

A chattering double point indication is noted as a **Fault** state.



NOTE

The settings for the monitoring criteria apply globally to all binary inputs. However, you can activate or deactivate the chatter blocking separately for each binary input (see chapter 5.8.3).

Proceed as follows:

- Select **Options > Chatter Blocking**. The **Chatter Blocking** dialog box is opened.

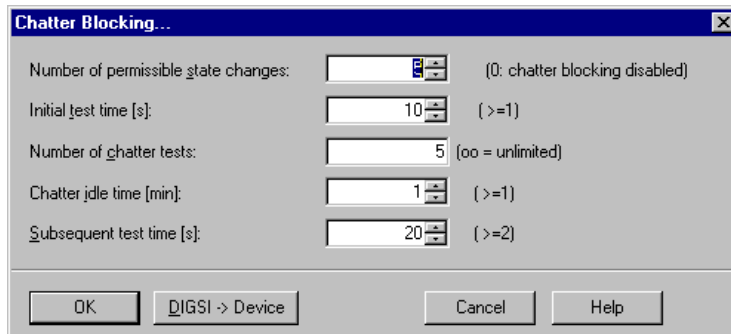

DIGISGB082

Fig. 5-34 Chatter blocking

Monitoring Criteria

The operation of the chatter blocking function is determined by setting the following parameters.

- Enter a number between 0 and 65535 in the **Number of permissible state changes** field. This number defines how often the state of a binary input is allowed to change within the chatter test time and the chatter check time. If this number is exceeded, the binary input becomes or remains blocked. When the value is 0, the chatter blocking is inactive.
- Enter a value between 1 and 65535 in the **Initial test time** box. The number you enter corresponds to the time in seconds. The number of state changes of a binary input is checked within this time. The time starts when a signal is first applied to the binary input.
- Enter a value between -1 and 32767 in the **Number of chatter tests** box. The number specifies the maximum number of check cycles to be executed before the binary input is finally blocked. The value **infinite** is also permissible here. This is entered by using the character string **oo** or by selecting the value **-1**.
- Enter a value between 1 and 65535 in the **Chatter idle time** box. The number entered corresponds to the time in minutes. If the number of permissible state changes of a binary input is exceeded within the chatter test time or chatter check time, the chatter pause time is started. The binary input is blocked during this time. It is only possible to enter a value in this field if the number of chatter checks is not equal to zero.
- Enter a value in the range of 2 to 65535 in the **Subsequent test time** box. The number you enter corresponds to the time in seconds. The number of state changes of the binary input is checked again over this time. The time starts as soon as the chatter pause time has elapsed. If the number of state changes is within the permissible limits, the binary input is enabled. If not, another pause time is started unless the maximum number of chatter checks has been reached. It is only possible to enter a value in this field if the number of chatter checks is not equal to zero.



NOTE

Chatter blocking cannot be set for default protective indications.

- Click the **DIGSI > Device** command button in order to transfer the values to the device. The command button is only active if you are working in the **Online** operating mode and if at least one value was changed.
- Click **OK** to apply your entries. The changes are only saved in the computer memory, **not** in files.

5.11 Setting Measuring Transducers

Measured value processing is carried out by the following predefined function blocks:

- Measuring transducer U (MU U)
- Measuring transducer I (MU I)
- Measuring transducer one-phase (MU1P)
- Measuring transducer three-phase (MU3P)
- Measuring transducer Aron (MUAron)

The measuring transducer blocks are configured to current and voltage channels of a bay controller in the DIGSI 4 configuration matrix. They form various operands from these input quantities. The individual measuring transducer blocks have to be activated in the functional scope of the device and are then displayed in the DIGSI 4 configuration matrix with their input channels and output quantities. The output quantities can then be configured to destinations.

A functional description of the measuring transducer blocks, a listing of the corresponding parameters as well as information and connection examples can be found in the device manual.



NOTE

Contrary to other SIPROTEC devices, configuration has to be carried out in the bay controller in each individual case. The device only contains some example applications.

Configuring of the measured values differs considerably from that of other SIPROTEC devices.

Configuration is described briefly below.

Proceed as follows:

- Select the measuring transducer blocks which are to be contained in the functional scope of the device and adapt the parameter settings of the measured transformers to your requirements (see chapter 5.3).
- Configure the measured value channels to the voltage or current inputs as the source in the DIGSI 4 configuration matrix.
Configure the calculated measured values, for example, to the system interface, CFC or display as the destination.

5.12 Configuring Limit Measured Values

Limit measured values are used to indicate when a measured value has exceeded the upper or lower limits.

Proceed as follows to carry out the configuration:

Inserting Measured Values

- Open the DIGSI 4 device matrix and use **Measured Values > Limit Measured Values** to insert the information types **Limit Measured Value (LVU)** and **Operational Measured Value (OMV)** from the information catalog into the **Measured Values** group (see chapter 5.7.1).

The limit measured value is configured automatically to the destination **Measured Value Window**.

- Configure the operational measured value with the setting **User MV** to the destination **Measured Value Window** (see chapter 5.5.11).
- Configure the operational measured value as a source and destination to CFC (**C**) and the limit measured value to CFC (**C**) as a destination (see chapter 5.5.14 and 5.5.15).
- Configure the properties of the measured values (see chapter 5.8.7).

Inserting an Indication

- Select **Indications Only** as the information type
- Use **Annunciation > Tagging** to insert the **ON / OFF (IE)** indication from the information catalog into the **Measured Values** group.
- Configure the indication as a source to CFC (**C**) and as a destination to the system interface (**S**) and the default display (**D**).

CFC

- Insert a new CFC chart.
- Insert one block each from the block catalog into the CFC chart. The LIVE_ZERO block passes the measured value of the measuring transducer on so that it can be displayed and compared.
- Interconnect the inputs and outputs of the blocks.
- Configure the **LIVE_ZERO** block, compile the chart and download the data to the bay controller.

The limit measured value can be displayed and (after a password has been entered) changed at the device under **Measured Values** in the **Limits** list.

5.13 Creating User-definable Functions with CFC

The **DIGSI 4 CFC** system component is used to configure individual logic functions via a graphical user interface, so that for example switching interlocks, switching sequences or limit checks can be implemented. In the process you interconnect the information of your SIPROTEC 4 device to the inputs and outputs of logical function blocks, compile them and download the result to the CPU of your device.

- Open the device, double-click **CFC** in the navigation window and double-click the CFC chart in the data pane. **DIGSI 4 CFC** is started and the chart is displayed.

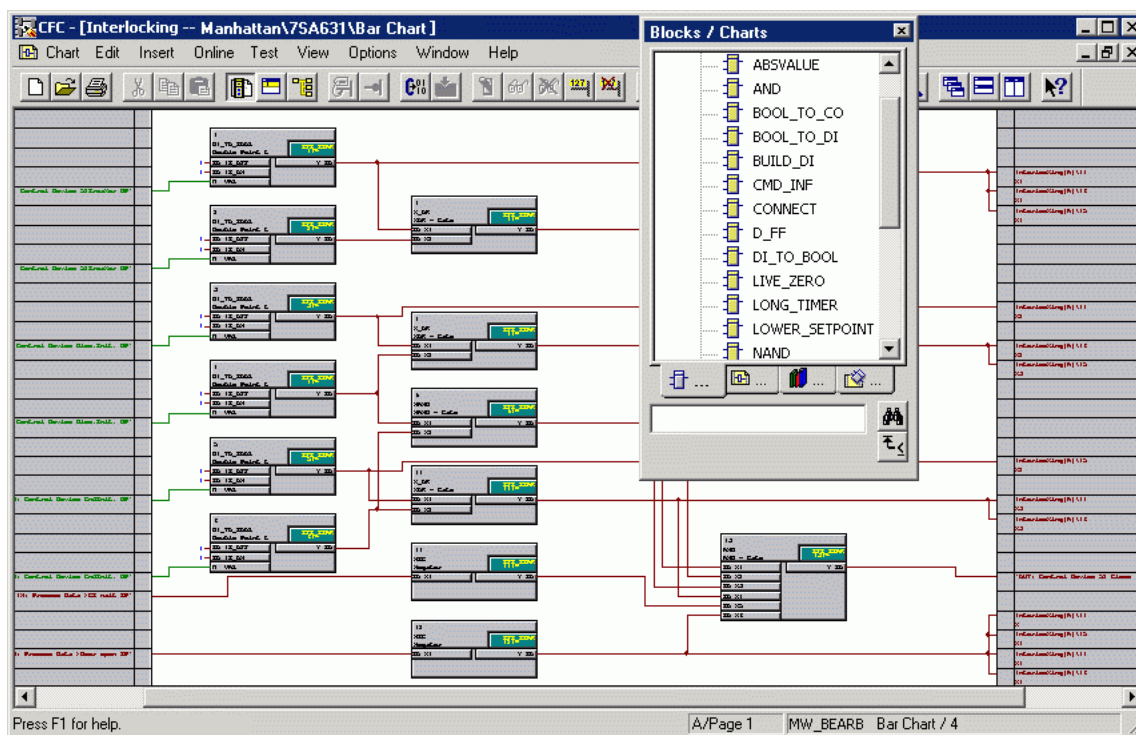

DIGSIGB062

Fig. 5-35 DIGSI 4 CFC

For information on the exact procedure for creating, compiling and downloading the CFC logic functions please refer to *DIGSI CFC, Manual /2/*.

5.14 Editing Default and Control Displays

On SIPROTEC 4 devices with graphical display you can display the process information in the display as default and control displays.

Select the information which you want to use in the display of the SIPROTEC display separately according to default and control display in the DIGSI 4 device matrix.

Create the display by means of the **DIGSI Display Editor** and connect it to the corresponding information of the SIPROTEC 4 device.

Default Display

The term "Default display" is used for the display shown automatically as the continuous display during the idle state of the device, meaning if no operation is carried out at the SIPROTEC device within a specified period.

The default display can consist of several pages.

in devices with 4-line display the default display shows the operational information and/or measured values of the feeder.

In devices with graphical display the default display is usually based on a graphical scheme of the feeder and can be configured individually. Switching operations are not possible when in the default display. Important operational measured values, such as the current and voltage in the feeder, can be displayed continuously. The display may also be used to display operational measured values.

One or more prepared default displays are available when a device is delivered. You can modify or replace them in order to adapt them to your system conditions.

Control Display

The control display is used in devices with a graphical display to represent the control devices with their respective switching positions. The control display is used to carry out switching operations, set taggings or overwrite switching positions. It can consist of several pages.

A prepared control display is available when a device is delivered. You can modify or replace it in order to adapt it to your system conditions.

- Use the **CTRL** key at the operator control panel of your SIPROTEC 4 device in order to change from the default to the control display.

Transferring Parameters

The default display and the control display are part of the parameter set of a SIPROTEC device which you load by means of **Device > DIGSI > Device** into the SIPROTEC 4 device.

**NOTE**

The subsequent action instructions are usually described on the basis of the menu commands.

Many of the menu commands can be called up faster by using icons on the toolbars.

Use **View > Toolbars...** to specify which toolbars are displayed and whether the tooltips are displayed. The **Toolbars** dialog box is displayed.

When you point the cursor to an icon in the toolbar, information on the corresponding menu command is displayed, provided the tooltips are activated.

In addition, keyboard shortcuts are available for many functions. These shortcuts are shown beside the individual menu commands.

Useful information can also be found in the status bar which you can hide or display by using **View > Status Bar**:

- Information on the operating action currently being carried out or, in display view, the cursor position on the drawing area,
 - The number of the displayed page and the number of pages,
 - The number of free characters for the definition of new symbols and devices,
 - The name of the symbol or device currently selected in the library,
 - The size of the symbol or device currently selected in the library,
 - The zoom factor of the display and
 - The state of the lockable keys.
-

5.14.1 Creating Default and Control Displays

In order to create a new display, first create an empty default display and an empty control display.

Creating an Empty Default Display

Proceed as follows in order to create an empty default display:

- Open the device.
- Select **Parameters** in the navigation window of DIGSI 4 and double-click in the data pane on **Default display**.

The Display Editor is started and the default display is displayed.

- Delete the standard default display with **Display > New**.

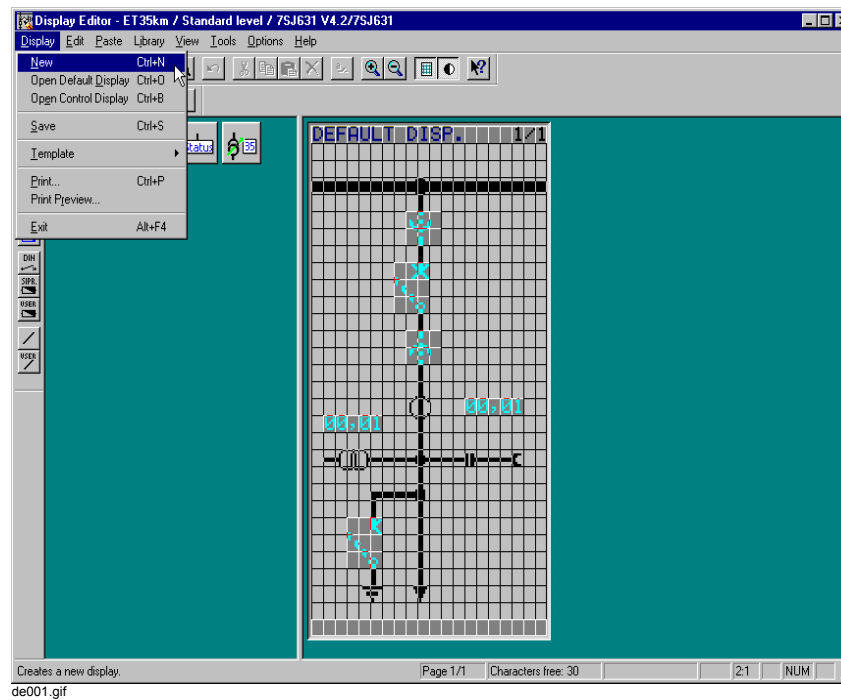

Fig. 5-36 Deleting a standard default display

- Save the empty default display with **Display > Save**.

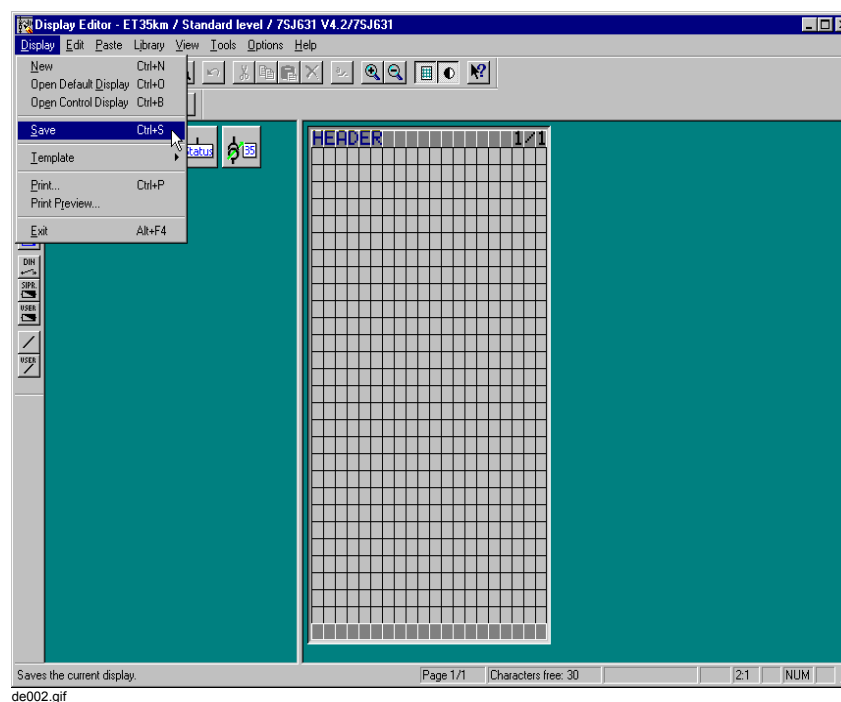

Fig. 5-37 Saving an empty default display

Creating an Empty Control Display

Proceed as follows in order to create an empty control display:

- Open the control display with **Display > Open Control Display**. The standard control display is displayed.
- Delete the standard control display with **Display > New**.
- Save the empty control display with **Display > Save**.

Displaying a Device Font

The displays created in the Display Editor are displayed semi-graphically in the display of the SIPROTEC device. The SIPROTEC device uses the device font for the display. The symbols and devices used in the default display and in the control display specify the individual characters of the device font.



NOTE

As long as there are free characters in the font, you can represent new symbols and devices in the default display and in the control display. The maximum number of free characters is available with an empty default display and an empty control display.

In order to display the current device font and to determine the number of free characters:

- Click **View > Display Device Font**. The **Device Font** dialog box is displayed.

The default and control displays are empty.

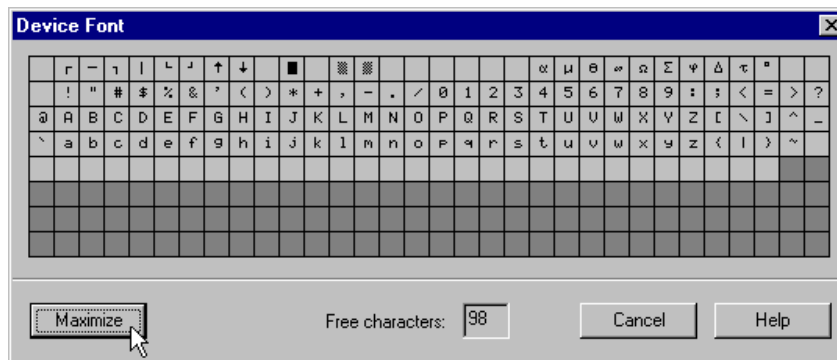

Fig. 5-38 Displaying a device font, example of German device language

- In zoomed display you can click on the >> or << command button to have the respective other half of the device font displayed.

5.14.2 Drawing and Configuring a Default Display

In order to draw and configure the default display:

- Open the default display.
- Enter the header.
- Draw the topology (for example busbar, feeder and grounding path).
- Position devices (in order to display information from the SIPROTEC device).
- Position symbols (for example ground electrode symbol).
- Position text.
- Check the completed default display.
- Save the default display and terminate the Display Editor.



NOTE

The displays created in the Display Editor are displayed semi-graphically in the display of the SIPROTEC device. As long as there are free characters in the device font, you can represent new symbols and devices in the default display and in the control display.

You have to make the maximum number of free characters available in order to be able to use as many new symbols and devices:

- Create an empty default device and an empty control display (see chapter 5.14.1).

In order to change an existing default display and use as many new symbols and devices as follows:

- Delete the symbols and devices which are not required from the default display and save the default display.
- Delete the symbols and devices which are not required from the control display and save the control display.

Drawn and Configured Default Display

Draw and configure the default display in the example:

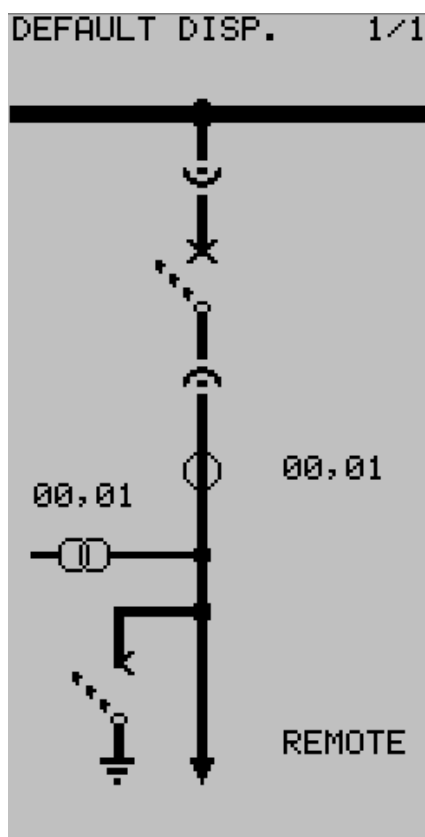

de005.gif

Fig. 5-39 Example of default display

In order to open the default display:

- Click **Display > Open Default Display**.

The default display is displayed in the drawing area.

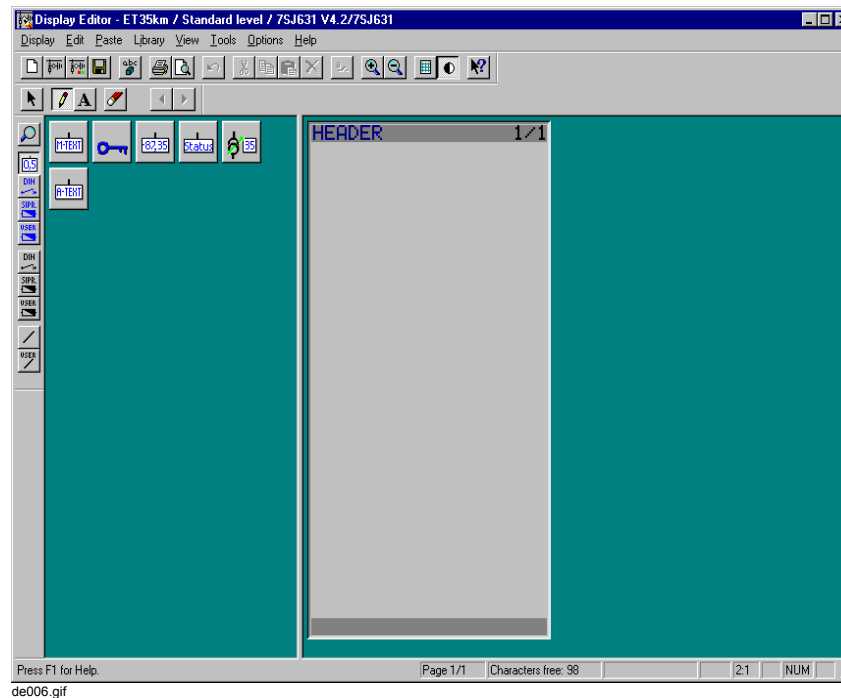

Fig. 5-40 Empty default display in the Display Editor (grid not displayed)



NOTE

The status bar displays the number of characters available for creating new symbols and devices in order to form your display.

In order to zoom the representation of the display in the Display Editor in or out, click **View > Zoom In** or **View > Zoom Out**.

In addition you can use **View > Grid** to hide or display a grid in the drawing area.

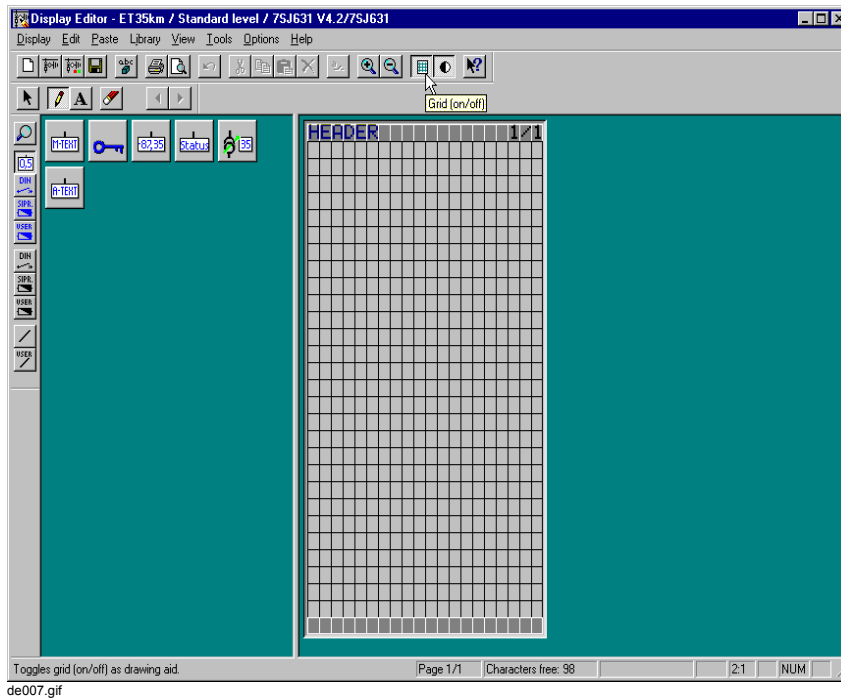

Fig. 5-41 Empty default display in the Display Editor (grid displayed)

Entering the Header

In order to enter the header in the default display:

- Click **Tools > Select**.
- Click with the left mouse button in the area of the header. The text input box is displayed.

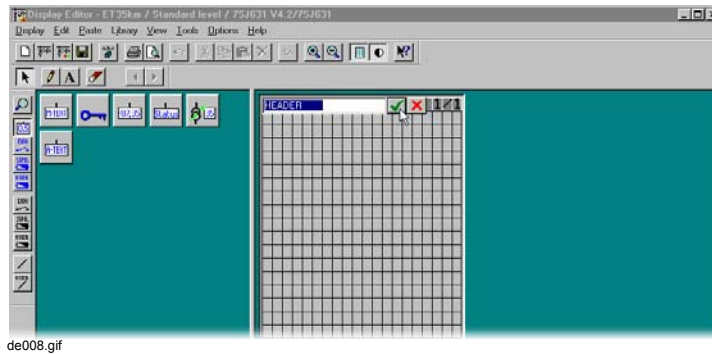

Fig. 5-42 Opening the header for an entry

- Enter the desired text in the opened text input box.

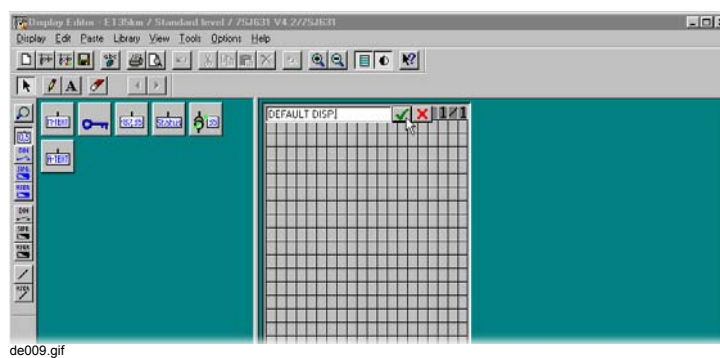

Fig. 5-43 Text input box in the header



NOTE

You can enter a maximum of 14 characters in the header of the display of a SIPROTEC device.

- Accept the header by using the ENTER key or by clicking on the check box to the right of the text input box.

5.14.3 Drawing the Topology

When drawing the topology you represent the busbar, feeder and grounding path in the default display. You use vertical and horizontal lines for this purpose. The lines consist of individual line symbols.

You use the corresponding symbols from the line library at the intersection points of vertical and horizontal lines.

Default Display with Topology

The topology is drawn in the example:

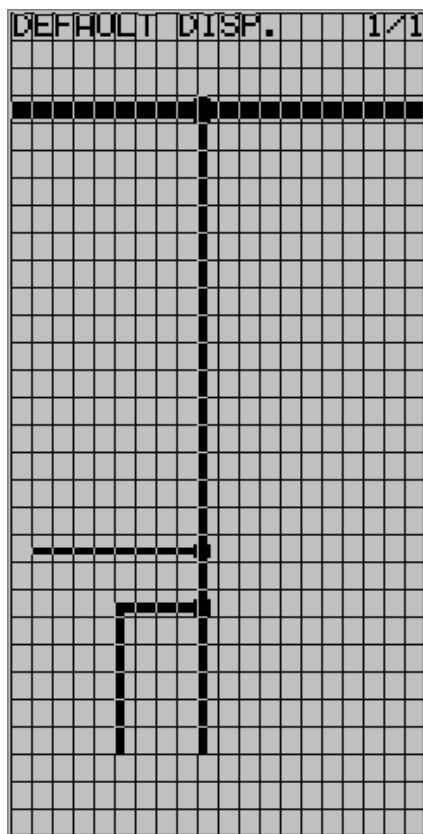

de014.gif

Fig. 5-44 Default display with topology (grid displayed)

Drawing Vertical Lines

In order to draw a vertical line:

- Click **Library > Select Library....** The **Select Library** dialog box is displayed.
- Select the **Line** library in the **Library** list box and confirm your selection by clicking **OK**.

**NOTE**

If you want to create your own line symbols, save them in the **User Line** library (see chapter 5.14.13).

- Click a suitable vertical line symbol (for example L2v).

**NOTE**

If you point the cursor during normal display on a symbol in the library, the symbol name is displayed, provided that the tooltips are activated (e. g. L2v). You can use **Library > Zoom In** to magnify the symbol display. The zoom factor is specified under **Options > Settings...**

The **Library** menu also contains sorting functions.

- In the drawing area of the default display click the starting point of the line and keep the mouse button pressed.
- Drag the cursor to the end point of the line and release the mouse button.

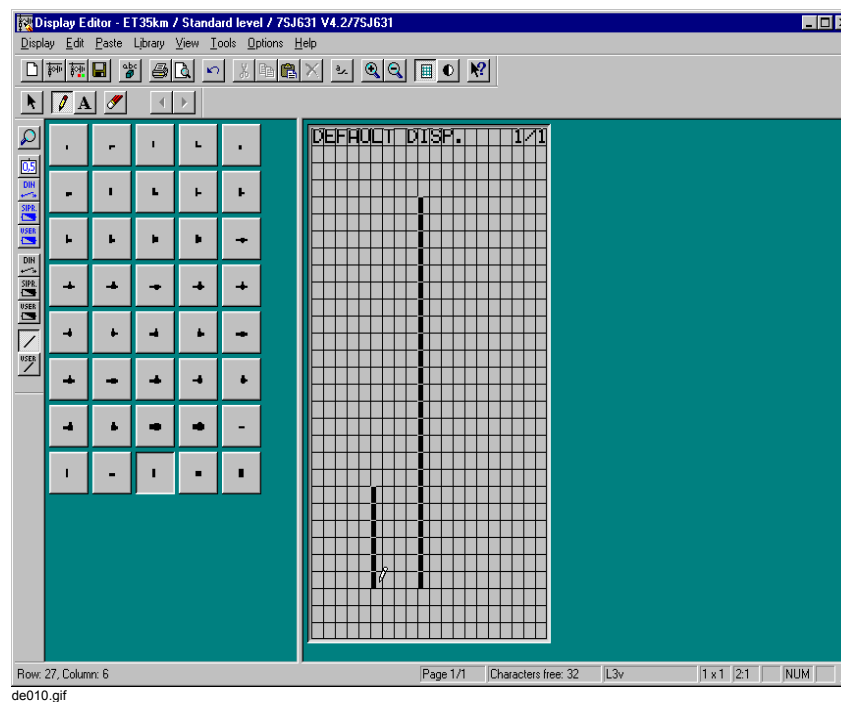

Fig. 5-45 Drawing vertical lines

Drawing Horizontal Lines

In order to draw a horizontal line:

- Click **Library > Select Library....** The **Select Library** dialog box is displayed.
- Select the **Line** library in the **Library** list box and confirm your selection by clicking **OK**.
- Click a suitable horizontal line symbol (for example L3h, L2h).
- In the drawing area of the default display click the starting point of the line, keeping the mouse button pressed.
- Drag the cursor to the end point of the line and release the mouse button.

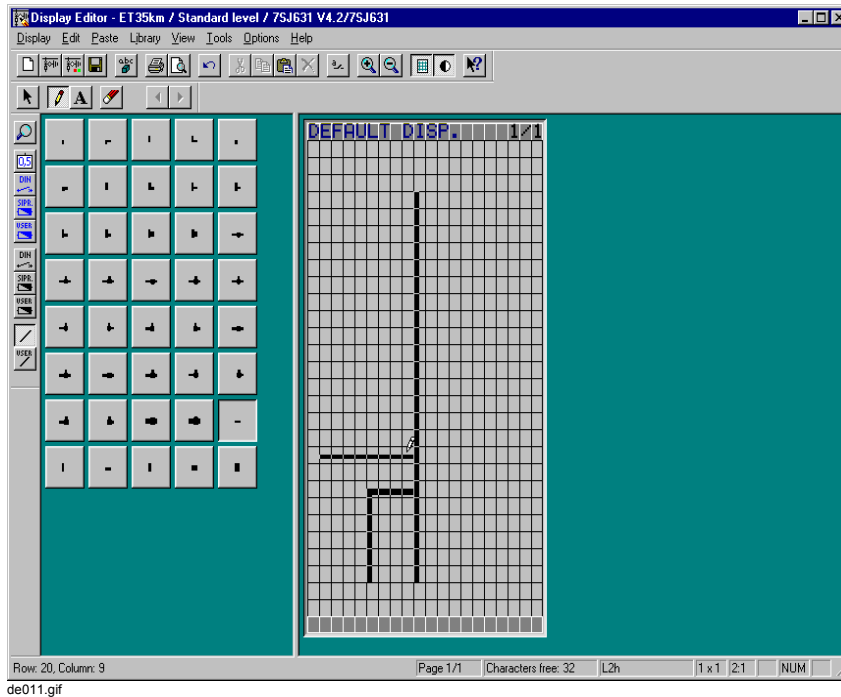
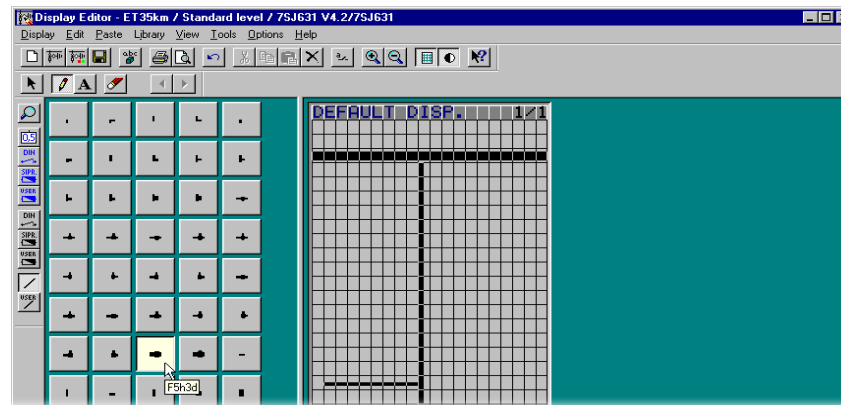

Fig. 5-46 Drawing horizontal lines

Drawing Intersections

In order to draw intersections of vertical and horizontal lines:

- Click **Library > Select Library....** The **Select Library** dialog box is displayed.
- Select the **Line** library in the **Library** list box and confirm your selection by clicking **OK**.
- Click a suitable line symbol (for example A3h2u).



de012.gif

Fig. 5-47 Selecting a suitable intersection symbol

- Click the intersection in the drawing area of the default display.

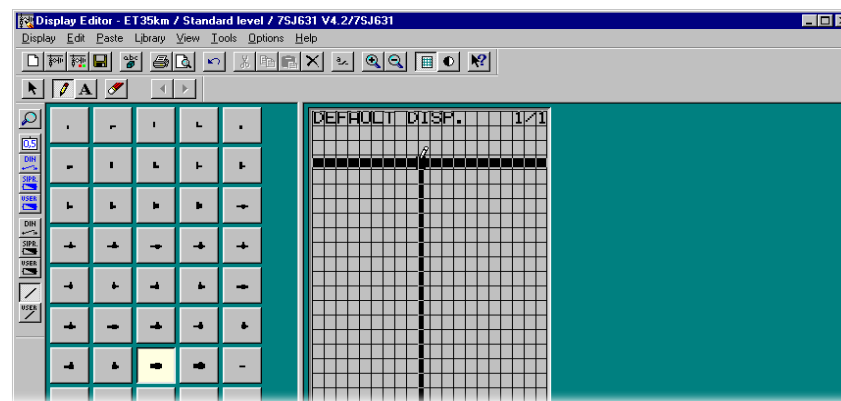

de013.gif

Fig. 5-48 Drawing an intersection

Deleting Line Symbols

In order to delete line symbols:

- Click **Tools > Erase**.
- Click the corresponding line symbol in the drawing area of the default display.

Deleting an Area

In order to delete an area:

- Click **Tools > Select**.
- While keeping the left-hand mouse button pressed draw a rectangle around the desired area and release the mouse button. The selected area is represented by a frame.
- Right-click in the selected area and select **Delete** in the displayed context menu.



NOTE

This function deletes all the symbols (meaning line symbols, symbols and text) and devices in the selected area.

Deleting All

In order to delete everything on the displayed page:

- Click **Tools > Select**.
- Click **Edit > Select All**. The complete page is selected with the exception of the header and footer.
- Right-click in the selected area and select **Delete** in the displayed context menu.

5.14.4 Positioning Devices

Devices are used to display values or states of the items of information of the SIPROTEC 4 device in the default display.

Select the items of information which you want to use in the default display beforehand in the DIGSI 4 device matrix (see chapter 5.5.9) and connect them in the Display Editor to the corresponding devices.

Default Display with Positioned Devices

In the example you position the devices marked by arrows:

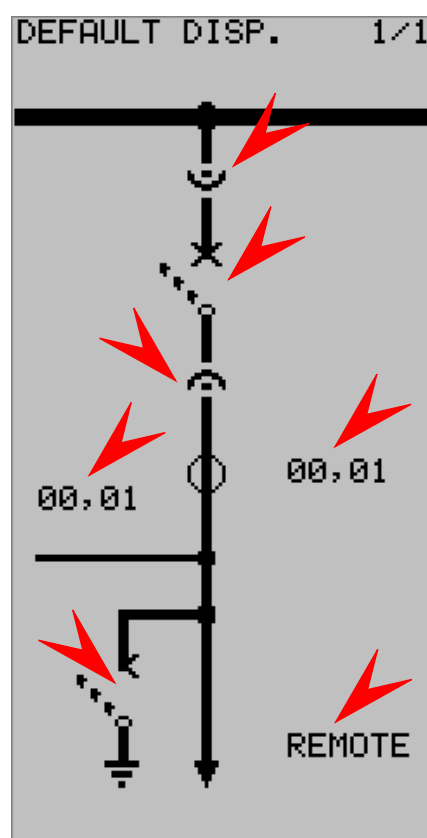

de018.gif

Fig. 5-49 Default display with positioned devices

Positioning Devices

In order to position a device, connect it to the information from the SIPROTEC 4 device and designate it, select a device library which contains the desired device:

- Click **Library > Select Library....** The **Select Library** dialog box is displayed.
- Select the desired library in the **Library** list box and confirm your selection by clicking **OK**.



NOTE

Device libraries are identified by the preceding identifier -.

Depending on the device type (value display, DIN state display, SIPROTEC state display or user display), the desired device may be contained in the libraries of the same name.

If the desired device does not exist in any library, you have to create a new device (see chapter 5.14.14).

Position the device in the drawing area of the default display:

- Click the device.



NOTE

If you point the cursor during normal display on a device in the library, information on the corresponding device name is displayed, provided that the tooltips are activated.

You can furthermore use **Library > Zoom In** to magnify the device display. The zoom factor is specified under **Options > Settings....**

The **Library** menu also contains sorting functions.

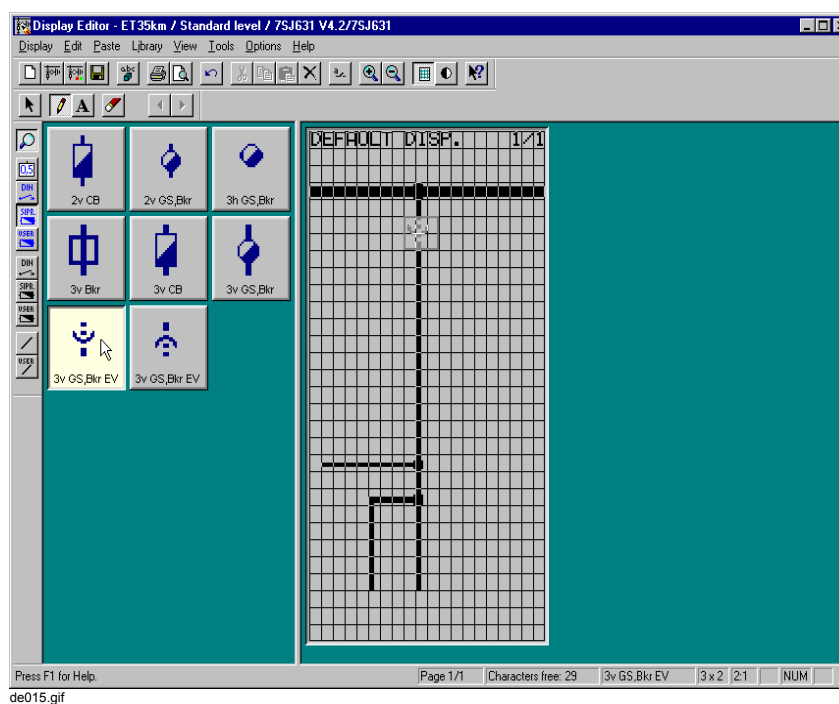

Fig. 5-50 Selecting Devices in the Library

- Click the insertion point for the device in the drawing area.



NOTE

If you keep the mouse button pressed while inserting, you can move the device in the drawing area.

Devices cannot be superimposed on other devices.

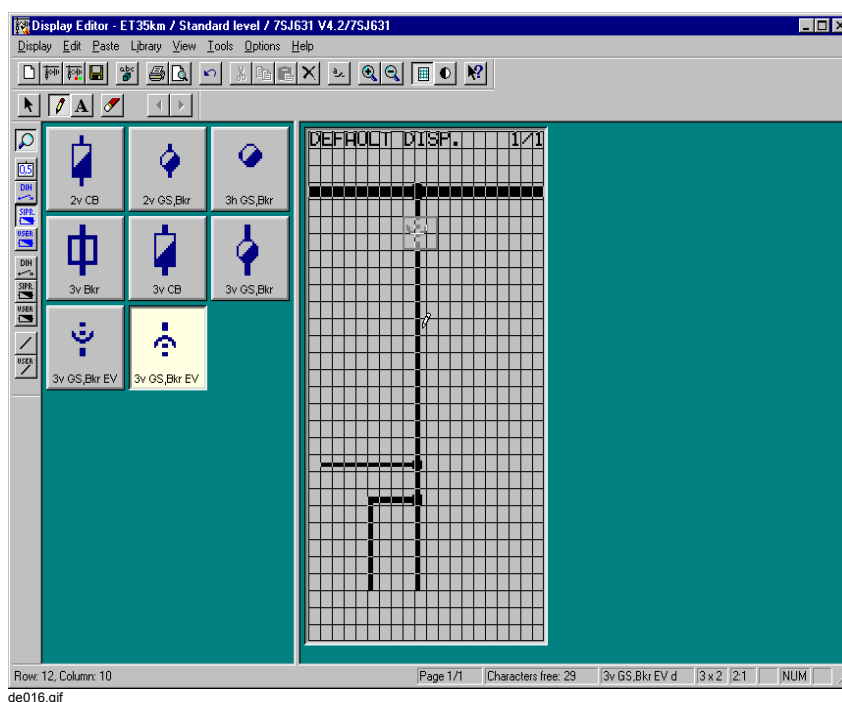

Fig. 5-51 Inserting devices in the default display

After you have inserted the device, the **Link** dialog box is displayed, so that the device can be linked to an item of information from the SIPROTEC device:

- Select the desired information in the list box.
Orientate yourself on the basis of the three columns **Group**, **Display Text** and **Type**.
- Confirm your selection by clicking **OK**.



NOTE

The **Link** dialog box only offers such items of information which are suitable for the selected device and which you have selected previously in the DIGSI 4 device matrix for use in the default display (see chapter 5.5.9).

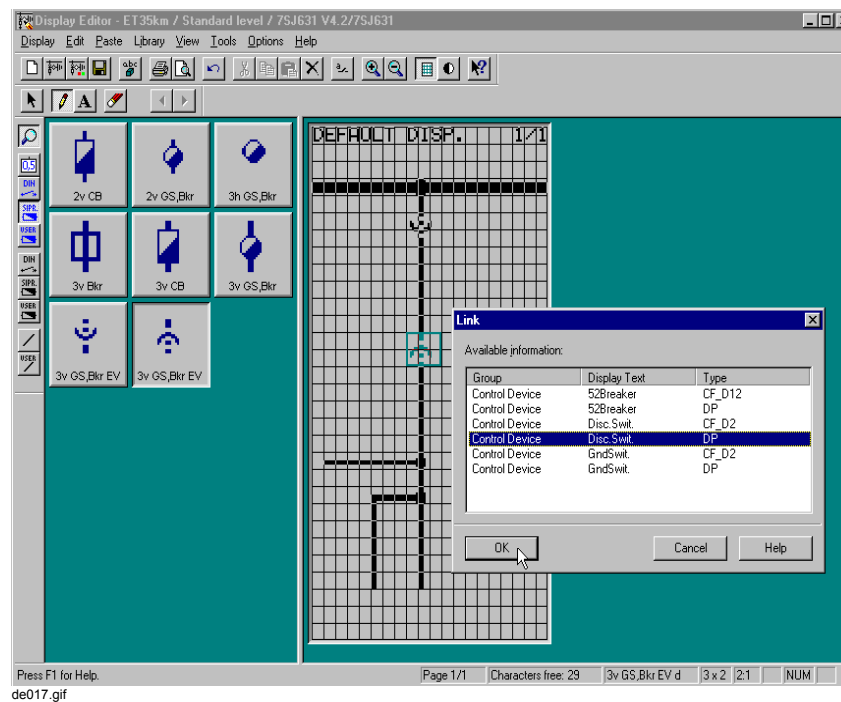

Fig. 5-52 Linking a device to information from the SIPROTEC device

After the device has been linked to an item of information, a text input box is displayed in order to allocate a designation in the default display:

- Enter the desired designation in the text input box. If you do not want to assign a designation to the device, abort the input by clicking the cross to the right of the text input box.
- Accept your input by clicking the check box to the right of the text input box.



NOTE

The maximum length of the designation is defined by the position of the device in the drawing area. It is limited automatically.

In order to enter a longer designation you have to move the text or text input box within the drawing area further towards the left:

- First accept the shorter designation.
- Click **Tools > Select**.
- Click the text and keep the mouse button pressed.
- Move the text to a suitable point further to the left and release the mouse button. You may not cover a device.
- Double-click the text in order to open the text input box.
- Enter the longer designation and accept your entry.

Moving a Positioned Device

In order to move a positioned device:

- Click **Tools > Select**.
- Click the device and keep the mouse button pressed.
- Move the device to the desired position and release the mouse. You may not cover another device.

Relinking Devices

In order to relink a device to information:

- Right-click on the device and select **Link** in the displayed context menu.
- In the displayed **Link** dialog box link the device to an information from the SIPROTEC device.
- Select the new information in the list box.
Orientate yourself on the basis of the three columns **Group**, **Display Text** and **Type**.
- Confirm your selection by clicking **OK**.

Deleting a Positioned Device

In order to delete a positioned device:

- Right-click on the device and select **Delete** in the displayed context menu.

**NOTE**

The text input box with the designation of the device remains positioned when the device is deleted and has to be deleted separately:

Right-click in the text input box and select **Delete** in the displayed context menu.

5.14.5 Using a User Text

The User Text device is used to display the dynamic states as text.

In the example the switching authority which is set at the device by means of a keyswitch is displayed by means of the User Text device.

Positioning a User Text

In order to position a User Text device:

- Click **Library > Select Library....** The **Select Library** dialog box is displayed.
- Select the **Displayed Values** library in the **Library** list box and confirm your selection by clicking **OK**.
- Select the device.

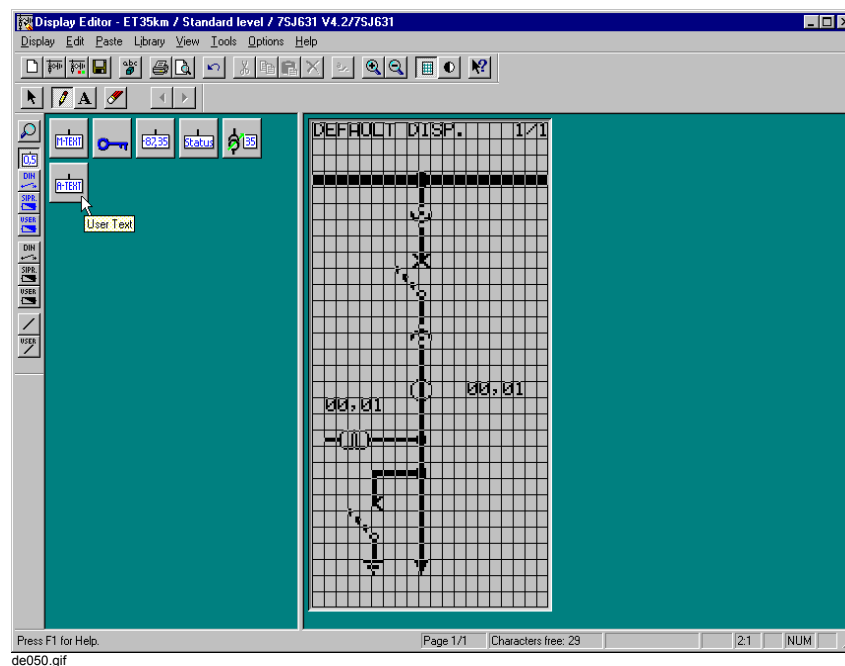

Fig. 5-53 Positioning a User Text

- Click the insertion point for the device in the drawing area.



NOTE

If you keep the mouse button pressed while inserting, you can move the device in the drawing area.

- Select the information to which you want to connect the User Text device in the **Link** dialog box.

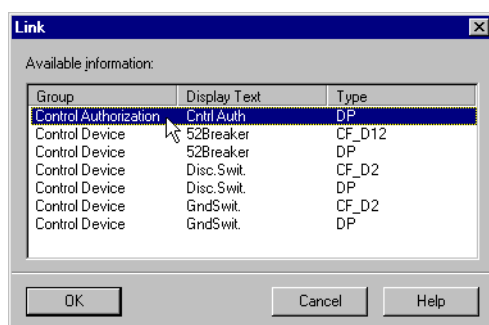

de051.gif

Fig. 5-54 Selecting information

- Click **OK** to confirm the selection. A text input box is opened.
- Abort the text input by clicking on the cross to the right of the text input box. This ensures that static text is not displayed.

**NOTE**

The User Text device consists of the two components, **static text** and **dynamic text**.

The static text is entered in the text input box. The dynamic text is assigned to the states of the device in the **Object Properties User Text** dialog box.

Assigning Text

In order to assign text to the device states:

- Click **Edit > Object Properties**. The **Object Properties - User Text** dialog box is opened.
- Enter the user texts in accordance with the states.



NOTE

If you do not want to assign a user text to a state, delete the preset text in the text input box. No text is then displayed in the device display if the state occurs during operation.

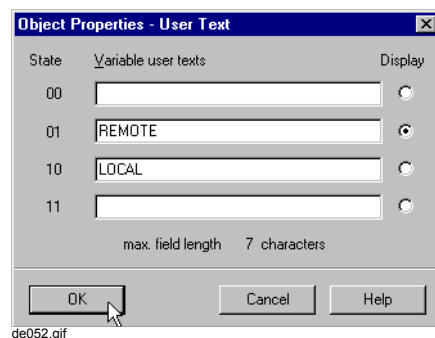

de052.gif

Fig. 5-55 Entering user texts, selecting the display

- Under Display select the line which is to be displayed in the Display Editor.
- Confirm your selection by clicking **OK**.

5.14.6 Positioning Symbols

Symbols are used to add static drawing elements to the default display.

Default Display with Positioned Symbols

In this example you position the symbols marked by arrows:

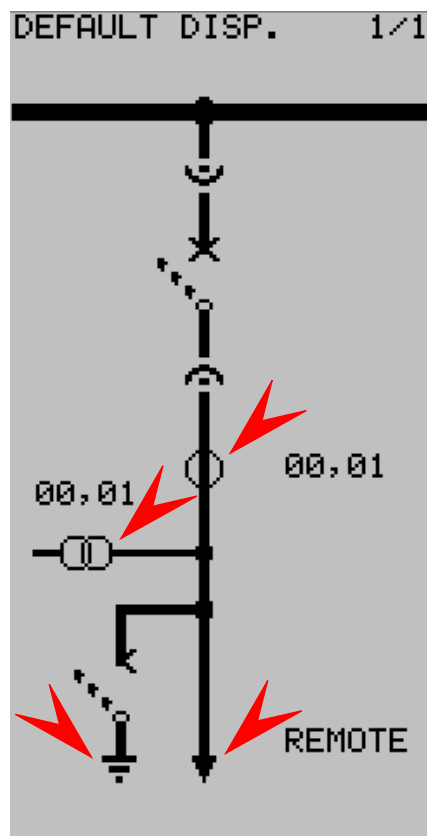

de005.gif

Fig. 5-56 Default display with positioned symbols

Positioning a Symbol

In order to position a symbol in the default display, select a symbol library which contains the desired symbol:

- Click **Library > Select Library....** The **Select Library** dialog box is displayed.
- Select the desired library in the **Library** list box and confirm your selection by clicking **OK**.



NOTE

Symbol libraries do not have a preceding identifier -.

Depending on the type of symbol (DIN, SIPROTEC or user symbol), the desired symbol is contained in the libraries with the same name or a new symbol has to be created (see chapter 5.14.13).

Position the symbol in the drawing area of the default display:

- Click the symbol.



NOTE

If you point the cursor during normal display on a symbol in the library, information on the corresponding symbol name is displayed, provided that the tooltips are activated.

You can furthermore use **Library > Zoom In** to magnify the symbol display. The zoom factor is specified under **Options > Settings....**

The **Library** menu also contains sorting functions.

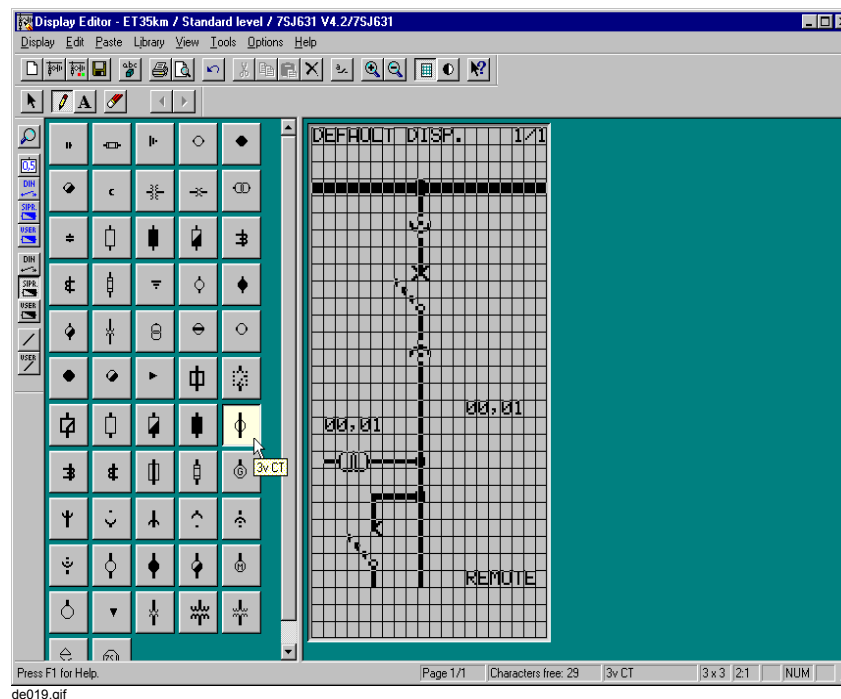

Fig. 5-57 Selecting a symbol for inserting

- Click the insertion point for the symbol in the drawing area.



NOTE

If you keep the mouse button and the CTRL key pressed simultaneously while inserting the symbol, you can move the symbol in the drawing area.

Symbols may not overlap any devices.

When you insert a symbol on top of other symbols (lines, text or other symbols), those symbols are deleted.

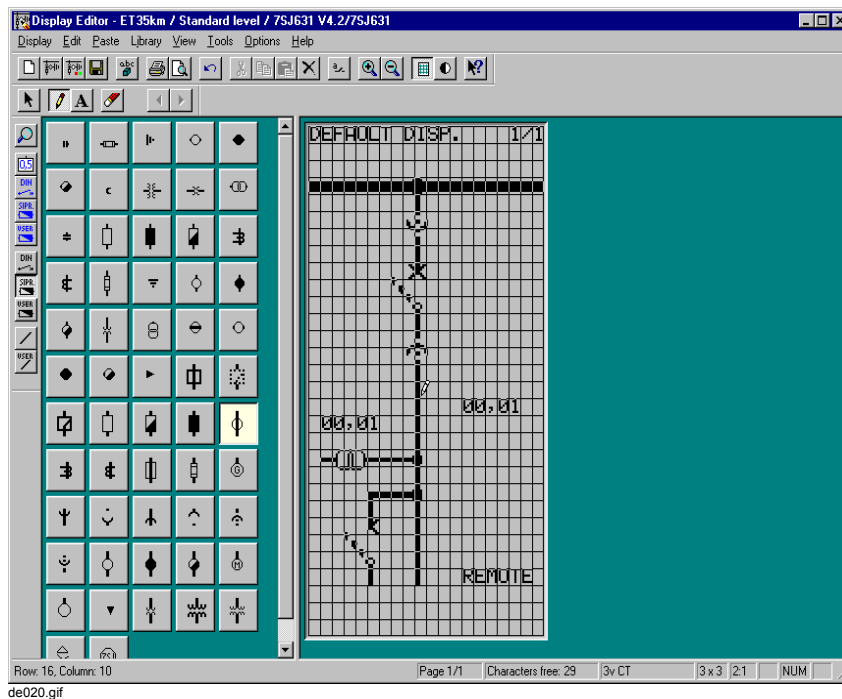

Fig. 5-58 Inserting a symbol in the default display

Moving a Positioned Symbol

In order to move a positioned symbol:

- Click **Tools > Select**.
- Click the symbol and keep the mouse button pressed.
- Move the symbol to the desired position and release the mouse. You may not cover a device.

Deleting a Positioned Symbol

In order to delete a positioned symbol:

- Right-click on the symbol and select **Delete** in the displayed context menu.

5.14.7 Positioning Text

In order to position a text in the default display:

- Click **Tools > Insert Text**.
- Click the insertion point for the text in the drawing area.
- Enter the desired designation in the text input box.
- Accept your input by clicking the check box to the right of the text input box..



NOTE

Texts may not overlap any devices.

When you insert a text on top of other symbols (lines, other text or symbols), those symbols are deleted.

The maximum text length is determined by the number of free characters to the right of the insertion point in the drawing area and is limited automatically.

In order to enter a longer text you have to move the text or text input box within the drawing area further towards the left:

- First accept the shorter designation.
- Click **Tools > Select**.
- Click the text and keep the mouse button pressed.
- Move the text to a suitable point further to the left and release the mouse button. You may not cover a device.
- Double-click the text in order to open the text input box.
- Enter the longer designation and accept your entry.

Moving a Positioned Text

In order to move a positioned text:

- Click **Tools > Select**.
- Click the text and keep the mouse button pressed.
- Move the text to the desired position and release the mouse. You may not cover a device.

Deleting a Positioned Text

In order to delete a positioned text:

- Right-click on the text and select **Delete** in the displayed context menu.

5.14.8 Checking the Default Display

In order to check the default display you can

- Hide the grid in the drawing area,
- Highlight the positioned device,
- Display the default display in normal size,
- Print out the default display.

Hiding the Grid

In order to hide the grid in the drawing area:

- Click **View > Grid**. The grid is hidden.

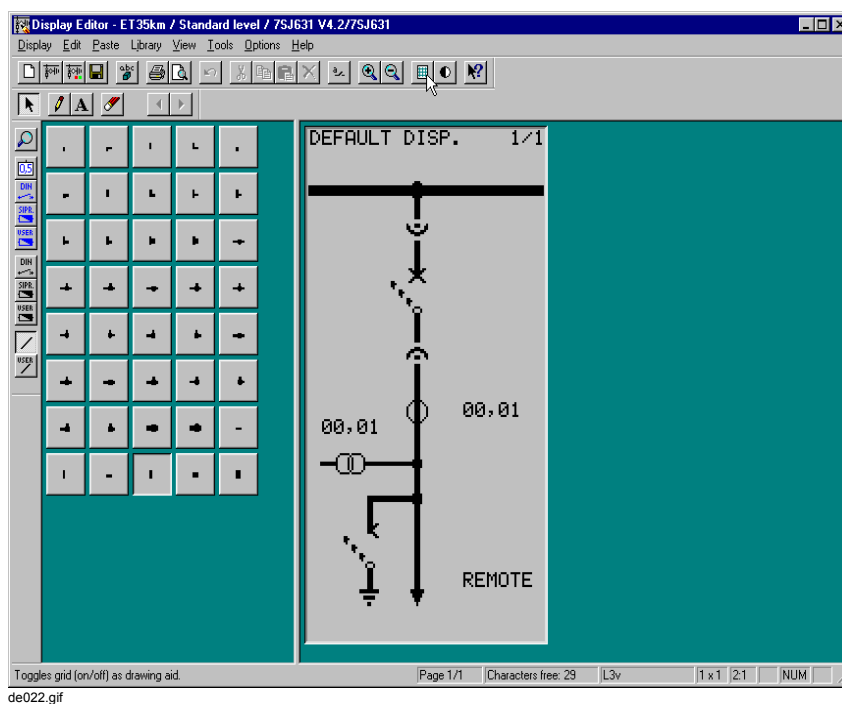

Fig. 5-59 Hiding the grid

- If you click again on **View > Grid**, the grid is displayed again.



NOTE

If the display size is too fine, you cannot display the grid. The menu command is hidden. In this case increase the display size by using **View > Zoom In**.

Highlighting Devices

In order to highlight the positioned devices in the drawing area:

- Click **View > Highlight Display**. The positioned devices have a grayed background.

**NOTE**

In addition to the devices, the corresponding designations (see chapter 5.14.4) and the header or footer (see chapter 5.14.4) have a grayed background.

Devices which are already linked to information from the SIPROTEC device are displayed in bright blue.

Devices which are not yet linked to information from the SIPROTEC device are displayed in dark blue.

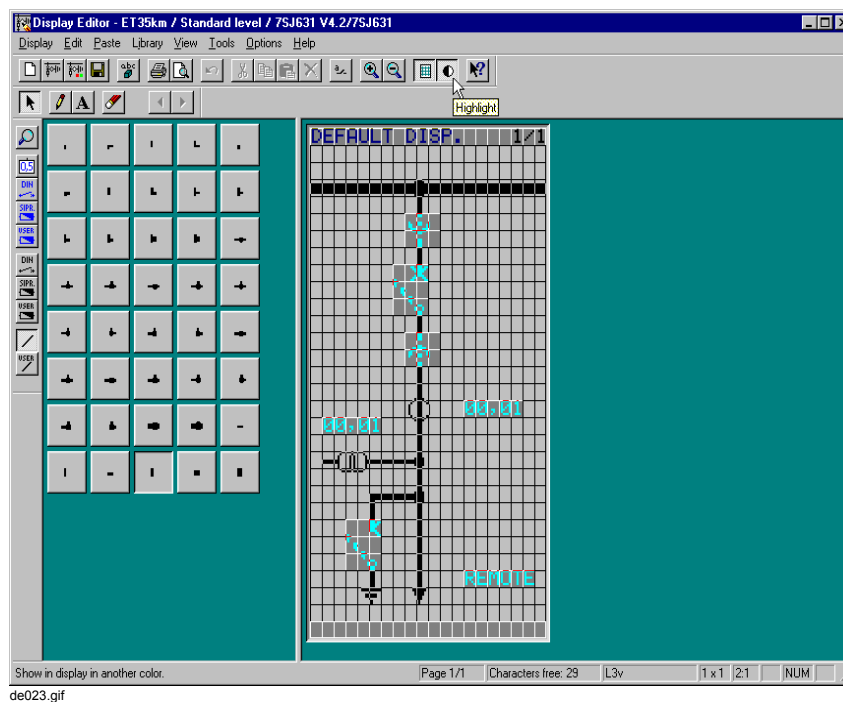

Fig. 5-60 Highlighting the display

- If you click once more on **View > Highlight Display**, highlighting is reversed.

Default Display in Normal Size Display

If you set the default display to normal size, a schematic representation of the SIPROTEC device is shown with the default display shown in the display:

- Click **View > Normal Size**.

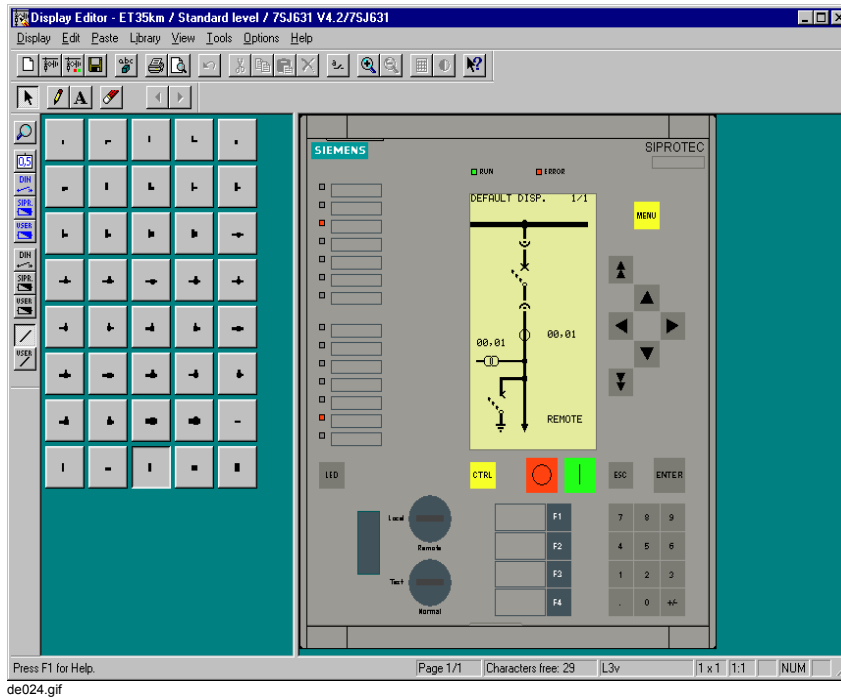

Fig. 5-61 Default display in normal size

- If you click **View > Zoom In** again, the schematic representation of the SIPROTEC 4 device is no longer displayed.

Printing Out the Default Display

In order to print out the default display:

- Click **Display > Print...**. The **Print / Print Preview** dialog box is opened.
- Click **Display** in order to print out the display. You can also customize the printout by using the options **Fit display to page** and **Print display with front panel**.

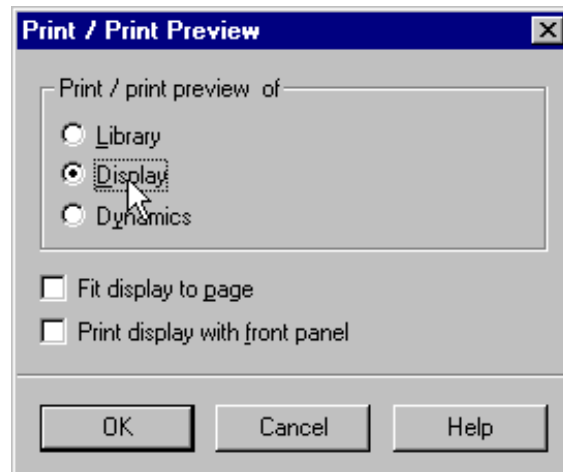

de039.gif

Fig. 5-62 Printing the display

- In order to print out the devices contained in the default display and their properties in the form of a table, click **Dynamics**.
- Click on **OK** in order to confirm your settings and display the standard **Print** display box. Start the printout via the standard **Print** dialog box.



NOTE

You can use the **Library** option under **Print / Print Preview** to print the currently selected library.

5.14.9 Saving the Default Display

In order to save the default display in the parameter set:

- Click **Display > Save**.
- Respond to the confirmation queries for saving with **Yes**.



NOTE

In order to use an existing page of the default display several times (for example as a template for a page of the control display) you can save it as a template:

- Click **Display > Template > Save As...**
- The **Save As** dialog box is displayed. Select the desired storage location and enter the new file name. The file type is preset.
- Click **Save**.

In order to obtain a page of a default display from the template:

- Load the template into an empty page of the default display by using **Display > Template > Open...** (see chapter 5.14.1).
- Link the existing devices to the corresponding information from the SIPROTEC 4 device (see chapter 5.5.9).

Use **Display > Save** to save the default display in the parameter set.

5.14.10 Drawing and Configuring a Control Display

How to Proceed

A control display is created or changed by using the **Display Editor** in the **DIGSI 4** operating program. The basic procedure is the same as that used for creating and configuring the default display (see chapter 5.14.1).

The prerequisite for changing or creating a control display is the configuration of the switchgears used in the control display and of the messages controlling them. This ensures that the display is adapted dynamically to the respective switching state.

In order to modify the factory-preset settings and design, the same aids are used as for the default display.

Proceed as follows in order to draw and configure the control display:

- Open the control display by clicking **Display > Open Control Display**.
- Enter the header.
- Draw the topology.
- Position devices.
- Position symbols.
- Position text.
- Check the completed control display.
- Save the control display.

**NOTE**

If you want to operate a field device via the control display you have to make the corresponding device operator-controllable after it has been positioned (see chapter 5.14.11).

In addition you specify a field device which is to be operated first after the control display has been called up at the SIPROTEC device (see chapter 5.14.12).

Drawn and Configured Control Display

Draw and configure the following control display in the example:

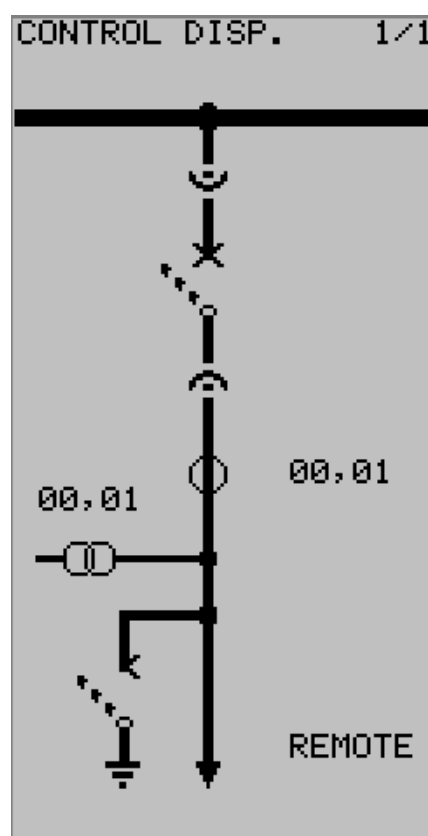

de025.gif

Fig. 5-63 Control display

5.14.11 Making a Positioned Device Operator-controllable

In order to make a positioned device, and thus a field device, operator-controllable from the control display:

- Double-click the device in the opened control display.
- Select the option **Object operator-controllable** in the displayed dialog box **Object Properties - Symbol**.



NOTE

The option is only active in the control display. Operation of a device is not possible in the default display.

- Confirm your selections by clicking **OK**.

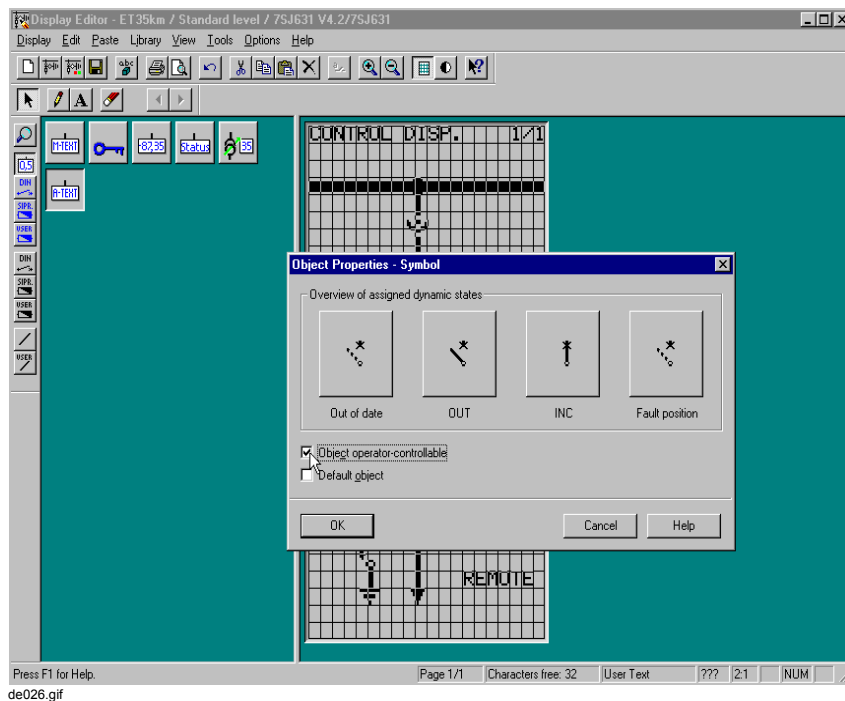

Fig. 5-64 Making a device operator-controllable

5.14.12 Specifying the First Operator-controllable Device

In order to specify a positioned device, and thus a field device which is to be operated first after the control device has been called up at the SIPROTEC device:

- Double-click the device in the opened control display.
- Select the option **Default object** in the displayed **Object Properties -Symbol** dialog box.
- Confirm your selections by clicking **OK**.



NOTE

Only one device can be the first operator-controllable device. This option is de-activated automatically for all other positioned devices.

Specify a field device which you want to switch first in the case of a fault (for example, circuit-breaker) as the first operator-controllable device.

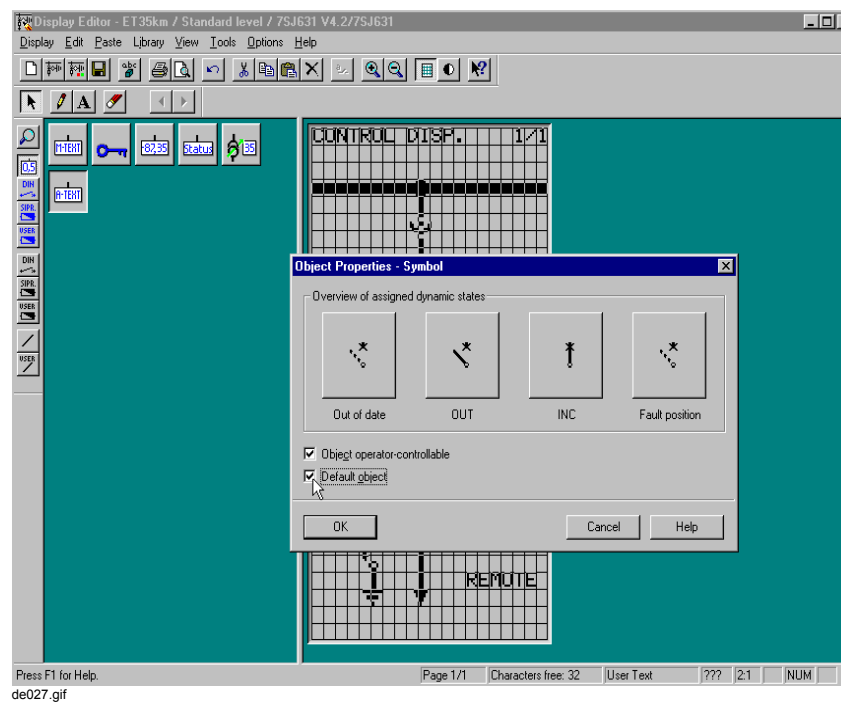

Fig. 5-65 Specifying the first operator-controllable device

5.14.13 Creating Symbols

In order to create a symbol:

- Open the default or control display in the Display Editor.
- Select the symbol library which you want to supplement.
- Create an empty symbol.
- Draw the symbol.
- Save the symbol.



NOTE

- Use the **Edit > Rename...** function to rename an existing symbol.
 - Use the **Edit > Duplicate...** function to duplicate and rename an existing symbol.
-

Creating a New Motor Symbol

In this example you create the new symbol **Motor new**:

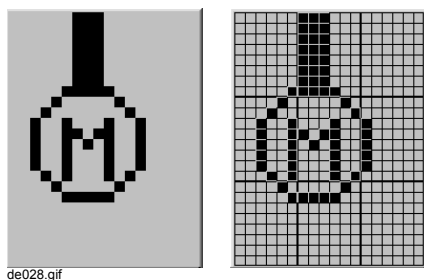

Fig. 5-66 New Motor symbol (without grid and with displayed grid)

Selecting a Symbol Library

In order to select a symbol library:

- Click **Library > Select Library....** The **Select Library** dialog box is displayed.
- Select the desired library in the **Library** list box and confirm your selection by clicking **OK**.



NOTE

Symbols can only be created in a symbol library (DIN Symbol, SIPROTEC Symbol or User Symbol).

Symbol libraries do not have a preceding identifier -.

Printing a Library

In order to print out the currently selected library:

- Click **Display > Print...**
The **Print / Print Preview** dialog box is opened.
- Click **Library** in order to print out the library.

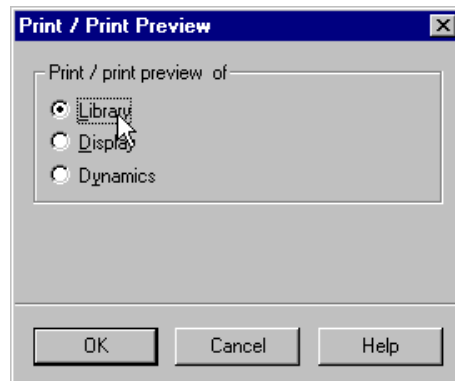

de040.gif

Fig. 5-67 Printing a library

- Click on **OK** in order to confirm your settings and display the standard **Print** display box.
Start the printout via the standard **Print** dialog box.

Creating an Empty Symbol

In order to draw a new symbol you first to have to create an empty symbol:

- Click **Library > New Symbol...**
- Specify the settings for the new symbol in the **New Symbol** dialog box that appears:
 - Enter the new symbol designation in the **Name** input box.
 - Select the symbol width by using the **Width** input box (1 to 8 characters).
 - Select the symbol height by using the **Height** input box (1 to 8 characters).

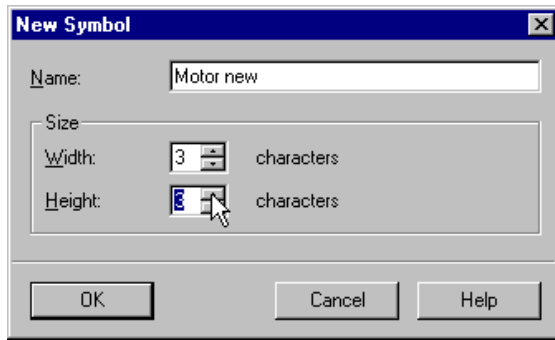

de029.gif

Fig. 5-68 Creating a new symbol

- In order to confirm your settings, click **OK**.



NOTE

After your settings have been accepted with **OK**, the Display Editor checks whether a new designation has been entered under **Name** and whether the name is already used in the library. If the name is already in use, an indication is displayed and the **New Symbol** dialog box remains open so that a new, unused designation can be entered.

An empty symbol is displayed in the drawing area of the Display Editor.

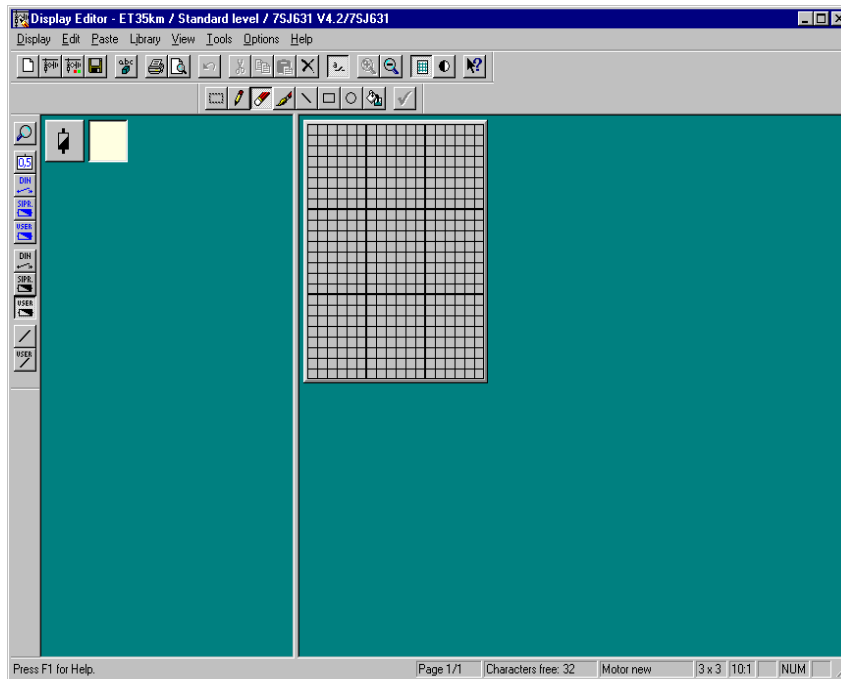

de030.gif

Fig. 5-69 New empty symbol

**NOTE**

If you point the cursor during normal display on a symbol in the library, information on the corresponding symbol name is displayed, provided that the tooltips are activated.

The tooltips are activated under **View > Toolbars....**

You can furthermore use **Library > Zoom In** to magnify the symbol display. The zoom factor is specified under **Options > Settings....**

The **Library** menu also contains sorting functions.

Drawing a New Symbol

You can use various **Tools** in order to draw the new symbol in the drawing area of the Display Editors:

- Pencil
The drawing width of the **Tools > Pencil** function is 1 pixel.
- Brush
The **brush size** of the **Tools > Brush** function is specified via **Options > Settings....**
- Line, rectangle and circle
The **line width** of the functions **Tools > Line**, **Rectangle** and **Circle** are specified via **Options > Settings....**
- Filling

Drawing Freehand

You draw freehand with **Tools > Pencil** and **Tools > Brush**.

**NOTE**

The right mouse button is used to delete.

Drawing a Line

In order to draw a line:

- Click **Tools > Line**.
- Click the starting point of the line and keep the mouse button pressed.
- Drag the cursor to the end point of the line while keeping the mouse button pressed then release the mouse button.

Drawing a Rectangle

In order to draw a rectangle:

- Click **Tools > Rectangle**.
- Click the starting point of the rectangle and keep the mouse button pressed.
- Drag the cursor to draw the rectangle while keeping the mouse button pressed then release the mouse button.

Drawing an Ellipse

In order to draw an ellipse:

- Click **Tools > Circle**.
- Click the starting point of the line and keep the mouse button pressed.
- Drag the cursor to draw the ellipse while keeping the mouse button pressed then release the mouse button.



NOTE

Keep the SHIFT key pressed while drawing the ellipse in order to draw a circle.

Filling a Surface

Select **Tools > Fill** and then click a point to activate all the neighboring points up to the next limitation.

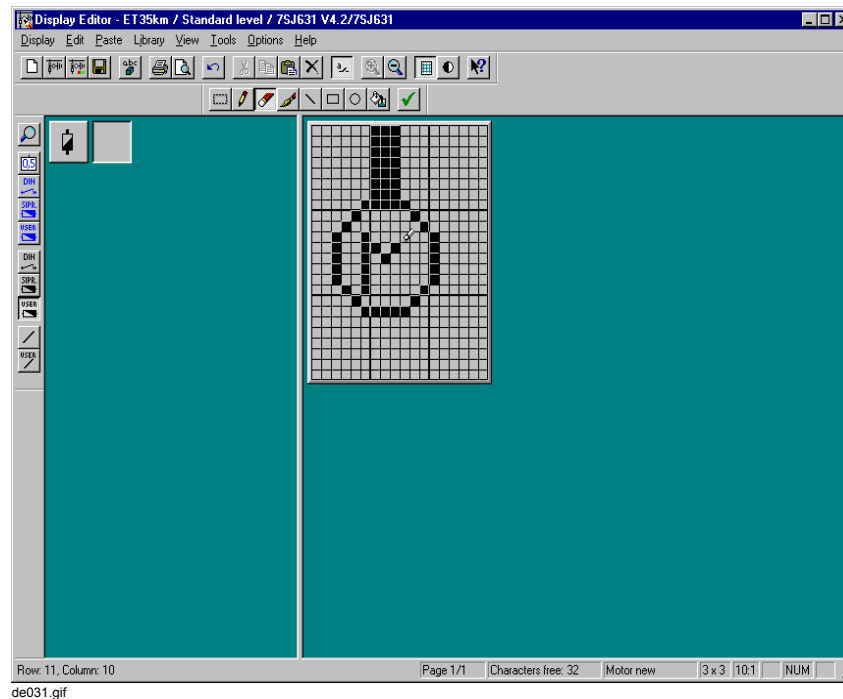

Fig. 5-70 Drawing a new symbol

Deleting Points

To delete points:

- Click **Tools > Erase**.
- Click individual points in order to delete them or keep the left mouse button pressed and move the cursor over the points to be deleted.



NOTE

You can use the right mouse button to delete points while drawing with the Pencil or Brush tools.

Deleting an Area

In order to delete an area:

- Click **Tools > Mark**.
- While keeping the mouse button pressed draw a rectangle around the desired area and release the mouse button. The selected area is represented by a frame.
- Click **Edit > Delete**.

Deleting All

In order to delete all the points of the symbol:

- Click **Edit > Select All**. The complete area is selected.
- Click **Edit > Delete**.

Moving an Area

In order to move an area:

- Click **Tools > Select**.
- While keeping the mouse button pressed draw a rectangle around the desired area and release the mouse button. The selected area is represented by a frame.
- Click **Edit > Cut**.
- Click **Edit > Paste**.
- Click the desired insertion point in the drawing area.



NOTE

If you keep the mouse button pressed during inserting, you can move the area to the exact insertion point. The contents of the copied area are displayed transparently.

Copying an Area

In order to copy an area:

- Click **Tools > Mark**.
- While keeping the mouse button pressed draw a rectangle around the desired area and release the mouse button. The selected area is represented by a frame.
- Click **Edit > Copy**.
- Click **Edit > Paste**.
- Click the desired insertion point in the drawing area.



NOTE

If you keep the mouse button pressed during inserting, you can move the area to the exact insertion point. The contents of the copied area are displayed transparently.

Saving a Symbol

In order to save the new symbol in the current library:

- Click **Tools > Accept**. The new symbol is displayed in the library.

**NOTE**

New symbols are saved permanently in the respective library.
The symbols can be used in any SIPROTEC 4 device with a large display in the default and control display.

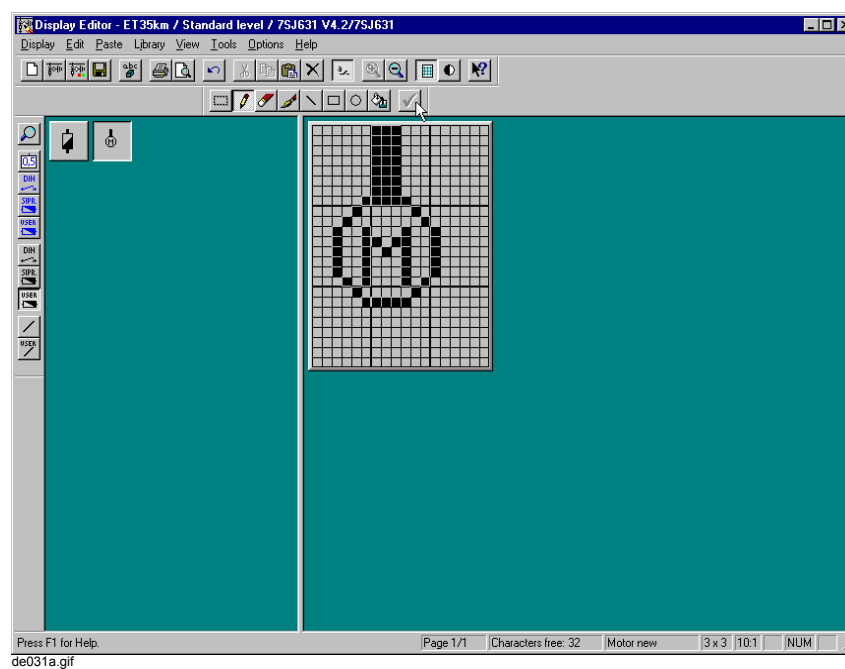

Fig. 5-71 Accepting a new symbol

Deleting a Symbol

In order to delete a symbol from the current library:

- Right-click on the symbol and select **Delete** in the displayed context menu.

5.14.14 Creating a Device

In order to create a device:

- Open the default or control display in the Display Editor.
- Select the device library which you want to supplement.
- Create the device of the required type.
- Specify the properties of the device.



NOTE

- Use the **Edit > Rename...** function to rename an existing device.
- Use the **Edit > Duplicate...** function to duplicate and rename an existing device.

Creating a Circuit Breaker Device

In this example you create the new circuit breaker device **CB New** of the type **Symbol** (in order to display changes in the state of the circuit breaker). Use the symbols from the DIN Symbol library: 2v LS_x, 2v LS_au and 2v LS_ein:



NOTE

- Use different symbols to represent different states of a device of the type **Symbol**.

If the desired symbols do not exist yet, you first have to create them (see chapter 5.14.13).

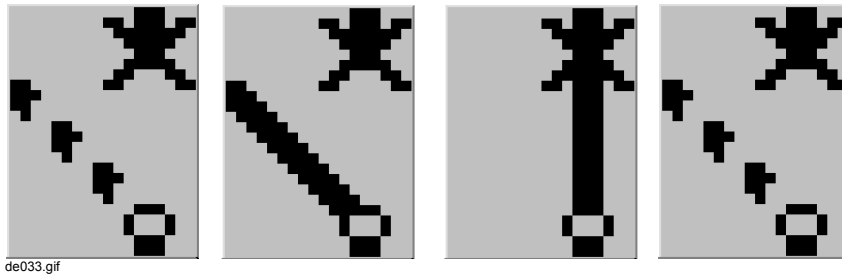

de033.gif

Fig. 5-72 Symbols for a new circuit breaker device CB New (Intermediate position 00, CLOSE, OPEN and Intermediate position 11)

Selecting a Device Library

In order to select a device library:

- Click **Library > Select Library....** The **Select Library** dialog box is displayed.
- Select the desired library (for example User Display) in the **Library** list box and confirm your selection by clicking **OK**.

**NOTE**

Devices can only be created in a device library (value display, DIN state display, SIPROTEC state display or user display).

Device libraries are identified by the preceding identifier -.

Creating a Device

In order to create a device:

- Click **Library > New Device....**

Specify the settings for the new device in the **New Device** dialog box then appears:

- Enter the new device designation in the **Name** input box.
- Specify the type of the device in the **Type** input box.
The type determines which type of information from the SIPROTEC device can be displayed.
- Select the device width by using the **Width** input box (1 to 8 characters).
- Select the device height by using the **Height** input box (1 to 8 characters).

**NOTE**

The **Width** and **Height** input boxes are only activated if the device is of the **Symbol** type.

The symbols have to have the same width and height as the device to which they are assigned, and should already exist.

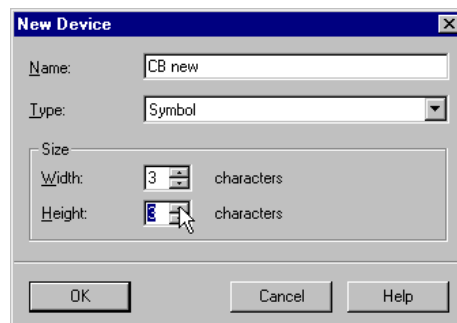

de034.gif

Fig. 5-73 Creating a device

- In order to confirm your settings, click **OK**.

**NOTE**

After your settings have been accepted with **OK**, the Display Editor checks whether the name is already used in the library.

If the name is already in use, an indication is displayed and the **New Device** dialog box remains open so a new, unused name can be entered.

The **Object Properties - Symbol** dialog box is displayed.

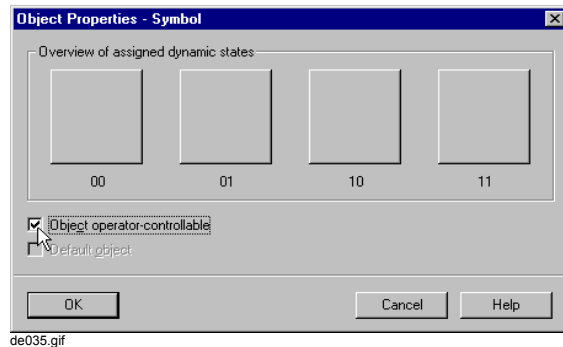

Fig. 5-74 Object Properties - Symbol

- Select the **Object operator-controllable** option in order to make the circuit breaker operator-controllable.
- In order to confirm your settings, click **OK**.

Specifying the Properties of the Device

Assign one symbol each from a library to the various states in the dynamic editor in order to specify the object properties of the created device of the **Symbol** type:

- Select the created device and click **Edit > Open Object**. The dynamic editor is opened.
- Click **Tools > Select Library...** or select the library by means of the toolbar (above the display of the state).

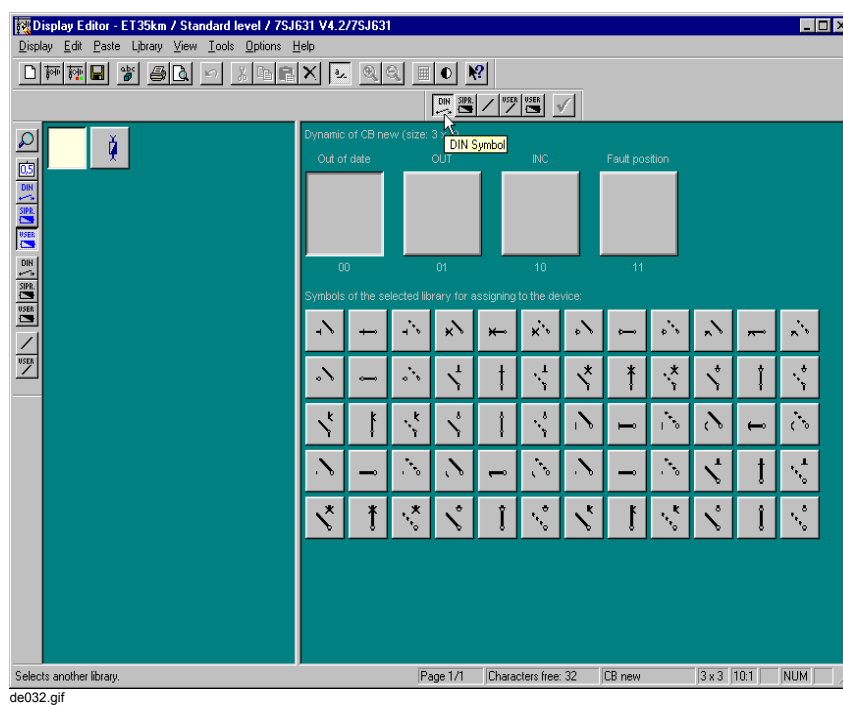

Fig. 5-75 Selecting a library

**NOTE**

Only the symbols whose size are suitable for the created device are displayed from the selected libraries.

- Click on the desired symbol and drag it onto the state of the device while keeping the mouse button pressed. The symbol is accepted after the mouse button has been released.

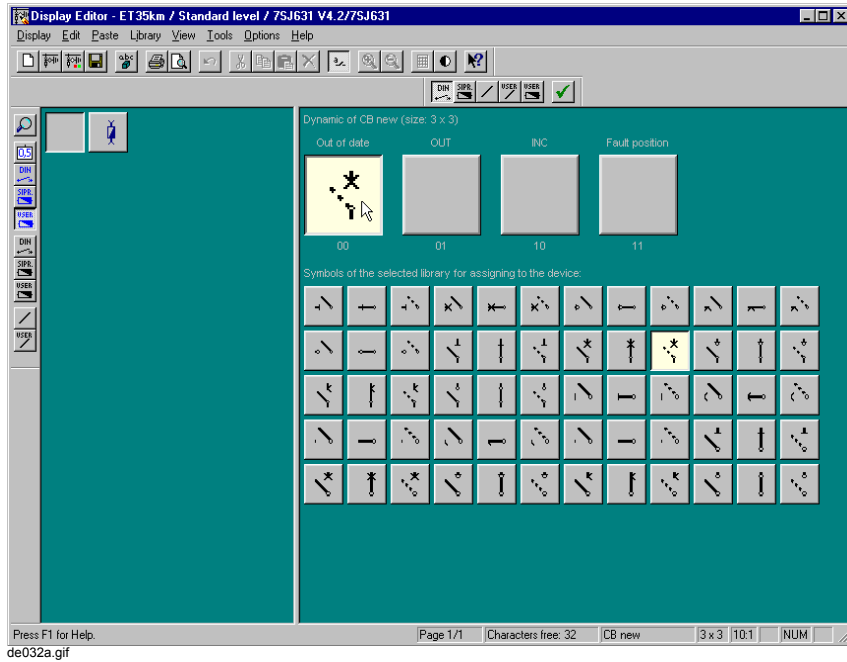

Fig. 5-76 Assigning symbols to device states

- Assign the corresponding symbol to each state.

- Accept your assignment by clicking **Tools > Accept**. The new device is displayed in the library.

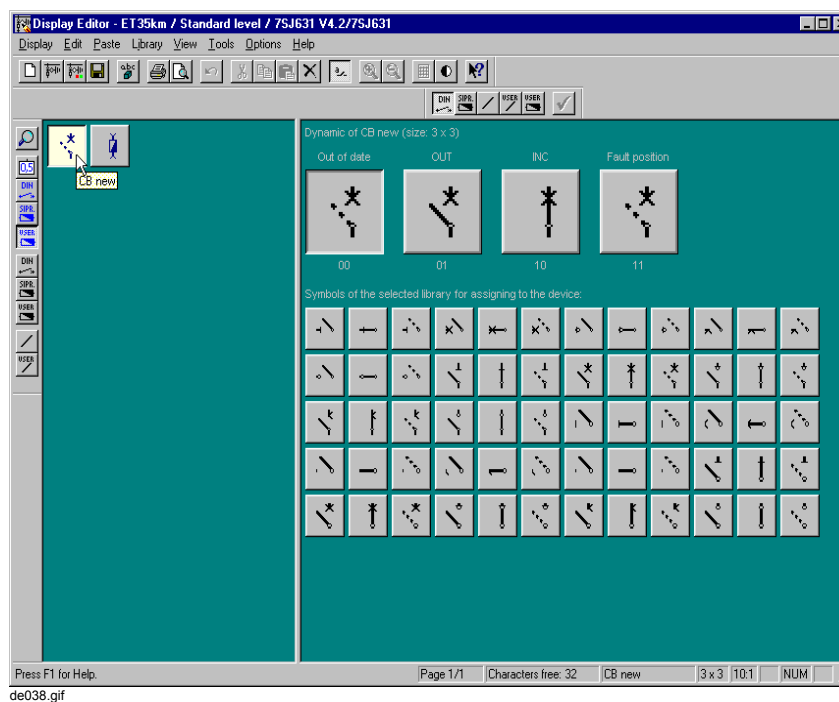

Fig. 5-77 Accepting the properties of the device

5.15 Setting Interface Settings

SIPROTEC devices can be equipped with external interfaces.

- The device is connected to higher-level control centers via the **system interface**. The following protocols are available depending on the device type and design:
 - IEC 60870-5-103
 - PROFIBUS FMS
 - PROFIBUS DP
 - DNP3.0 Level 2
 - MODBUS ASCII/RTU
 - IEC 61850 (Ethernet)
- A radio clock for time synchronization is connected via the **time control interface**.
- Connect the remote diagnostic facility, for example DIGSI 4, via modem and/or star coupler, to the **service interface**. All the DIGSI 4 operations are possible via this interface.
- The **operator interface** is used to connect to a local PC with DIGSI 4 installed. Via this interface the parameter settings of the device can, for example, be loaded and all operations which are possible with DIGSI 4 can be carried out, such as reading out fault records or operational indications.



NOTE

The system interface can be equipped with different modules for connection to other devices, for example via optical fibers, RS485 or RS232 interface.

The interfaces are configured via DIGSI 4. To be able to establish a link between a computer and a SIPROTEC 4 device, the values of the serial port settings of the two components must be identical. For information on the procedure for configuring the interfaces in their various forms please refer to chapter 7.

5.16 Date and Time Setup

Precise recording of process data requires exact time synchronization of the devices. The integrated date/time setup allows the exact time-specific assignment of events, for example in the operational and fault indications or the minimum-maximum-value lists.

The SIPROTEC 4 device offers the following **synchronization possibilities**:

- ❑ **Internal clock** (default setting)
SIPROTEC 4 device without external time synchronization even if the auxiliary voltage is temporarily switched off, by means of the internal buffer battery. The time can be adjusted manually (see chapter 6.5.1).
- ❑ **Interface**
Time synchronization by message (protocol IEC 60870-5-103, PROFIBUS FMS, device-type specific protocols).
- ❑ **Radio clock module**
Time synchronization via radio pulse. A receiver or time signal generator for **IRIG B**, **DCF 77** or a **SIMEAS-Sync.-Box** is required.
If the synchronization source fails, the internal time continues unsynchronized.
- ❑ **Binary input**
Time synchronization via a fixed binary input.
- ❑ **Ethernet NTP**
Time synchronization via **Ethernet NTP**.
- ❑ **GPS**
Time synchronization via **GPS**. For this time synchronization, the SIPROTEC 4 device must be equipped with a GPS receiver module.
If the synchronization source fails, the internal time is continued in an unsynchronized way.
- ❑ **Device-type-specific options**

Proceed as follows in order to configure the time synchronization:

- Open the device, click **Setting** in the navigation window and double-click in the function selection on **Time Synchronization**. The **Time Synchronization & Time Format** dialog box is displayed.

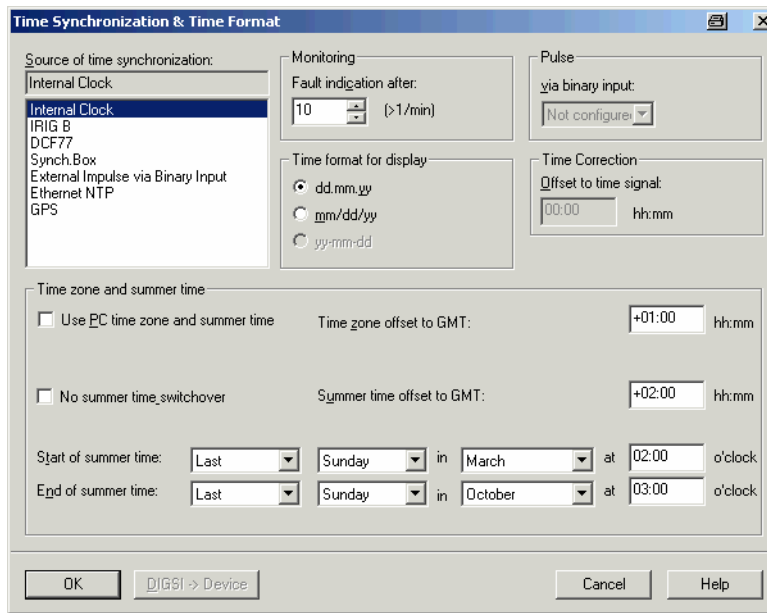

DIGSIGB056

Fig. 5-78 Time synchronization & time format

- Select the synchronization type in the **Source of time synchronization** box. If you synchronize via a binary input, select the binary input from the corresponding drop-down list box.
- Select the maximum time between two synchronization signals in the **Fault indication after** box in the **Monitoring** section. Values between 1 minute and 65535 minutes (45.5 days) are permitted. If the monitoring time has expired with no synchronization carried out, the device signals a time synchronization error.
As a rule the sources which can be connected to the device carry out the synchronization every minute with the exception of the binary input, from which the pulse can arrive in intervals of several minutes. The **Fault indication after** setting must therefore be at least 2 minutes and, in case a radio clock is used under poor receiving conditions, it should be even higher.
- Select the display of the date at the device display in the **Time format for display** section.
- If you have selected synchronization via IRIG B, DCF 77 or Synch.Box, you can correct the received time in the **Time correction** section. This allows you, for example, to adapt the time signal to the valid local time. Enter the value in hours and minutes in the **Offset to time signal** box. The maximum offset which can be set amounts to: $\pm 23 \text{ h } 59 \text{ min} = \pm 1439 \text{ min}$.
- Select the time zone and summertime switching for NTP-capable IEC 61850 devices in **Time zone and daylight saving time**. Specify the time zone via time offset to the GMT (Greenwich Mean Time). Specify the summertime switching by using the corresponding calendar dates. You can enter the information manually or take it from your PC.
If you use no synchronization source or a source other than NTP for a NTP-capable IEC 61850 device, **Time zone and daylight saving time** is not relevant for the device time but for the time stamp of IEC 61850 messages (the local device time is converted into UTC). **Time zone and daylight saving time** is not relevant for devices that are not NTP capable and is shaded in gray.

**NOTE**

If in the case of synchronization by means of a pulse via binary input, the current device time is set forward to the 0-th second of the next minute when the current second time is higher than 30 seconds when the positive edge of the pulse arrives. If the second time is lower, the 0-th second of the current minute is used. Monitoring of the signal is not carried out, every pulse acts directly on the time setup.

**NOTE**

If you use a radio clock, please note that it can take up to 3 minutes after the startup before the received time can be decoded securely. Only then is the internal time setup synchronized again.

In IRIG B the year has to be set manually because this standard does not include a year value. If a year value lower than "1991" is set by mistake in IRIG B, the year is reset to "1991" during the first synchronization.

Changing the Synchronization

When the type of synchronization is changed, the corresponding hardware is reset to the other synchronization source at the latest after one second. The cyclic synchronization is then initially lost and the time is regarded as faulty, as during a startup, until the new synchronization source takes over the task.

The cyclic synchronization is not lost if the synchronization offset changes during the time mode and if there is a change in the year at IRIB B. However, a time jump occurs. In order to draw your attention to this fact the time value is signaled with **Fault Clock ON** without the synchronization offset and then with **Fault Clock OFF** with the synchronization offset when the offset changes to the "jumping" minute of the time value.

Operational Indications of the Time Setup

After the **Fault Clock ON** indication the time may jump. This indication is triggered in the following cases:

- If a synchronization fault takes longer than the tolerance time, which is defined by the **Fault indication after** setting, or which is caused by a change in the type of synchronization;
- If a time jump is due afterwards. The indication is still indicated with the time **before** the jump.

The **Fault Clock OFF** is triggered in the following cases:

- When the synchronization functions again (for example after a receipt fault in case of radio clock receipt),
- Immediately after a time jump. This indication is displayed with the time **after** the jump so that the magnitude of the jump can be concluded.

5.16.1 Date/Time Setup in Devices with Protection Data Interface

The integrated date/time setup enables the exact timely assignment of events, e.g. those in the operational indications and fault indications or in the lists of the minimum/maximum values.

The time can be influenced by

- internal RTC (Real Time Clock),
- external synchronization sources (DCF77, IRIG B, SyncBox, IEC 60870-5-103),
- external minute pulses via binary input.

With a distance protection system where two or three 7SA522 devices are linked via the protection data interface (variant ordered), the time is usually synchronized only in *one* device, i.e. the so-called "absolute time master" which is always the device with the Index 1. It synchronizes the other device (or the other devices if there are more than 2 ends) via the protection communication. This ensures that all devices of the protection system operate exactly with the same time.



NOTE

On device delivery the internal clock RTC is always set by default as synchronization source, regardless of whether the device is equipped with a system interface or not. If the time synchronization is to use an external source, it must be selected.

Time Synchronization

For the time setup settings refer to DIGSI 4 - **Settings - Time Synchronization** (Figure 5-79).

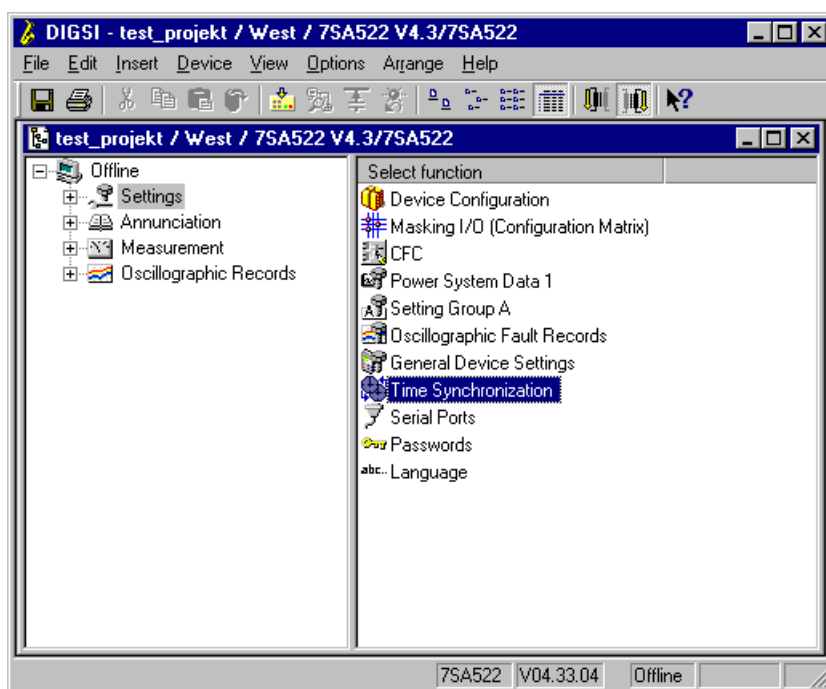

digsiGB160

Fig. 5-79 The window Settings in DIGSI 4 - Example

Double-click **Time Synchronization**. The **Time Synchronization & Time Format** dialog box opens (Figure 5-80).

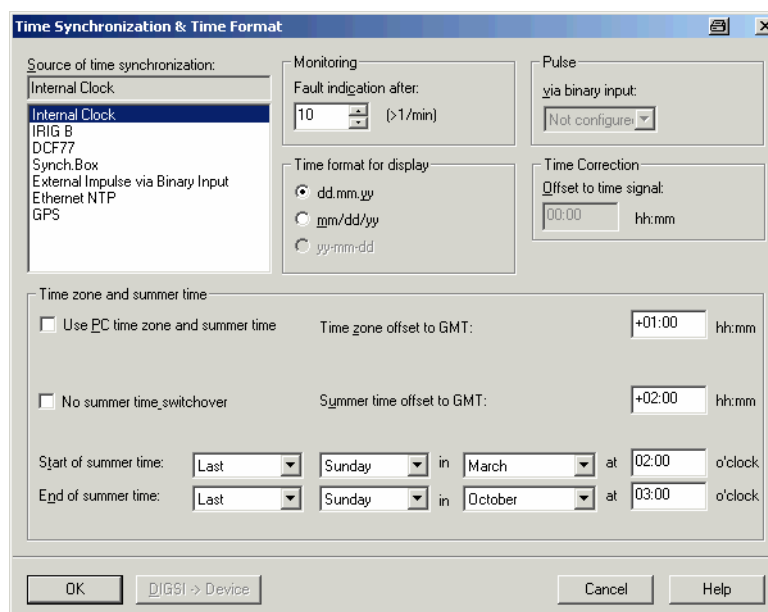

digsiGB161.tif

Fig. 5-80 Time Synchronization & Time Format dialog box in DIGSI 4 - Example

Specify here the factors for influencing the internal time setup. Select one of the operating modes No. 1 to 9 of Table 5-1 for the master device.

Table 5-1 Operating modes for time setup

No.	Operating mode	Explanations
1	Internal	Internal synchronization using RTC (default)
2	IEC 60870-5-103	External synchronization using system interface (IEC 60870-5-103)
3	Time telegram IRIG B	External synchronization using IRIG B
4	Time telegram DCF77	External synchronization via the time telegram DCF77
5	Time telegram Sync.-Box	External synchronization using SIMEAS Sync. Box time telegram
6	Minute pulse via binary input	External synchronization with minute pulse via binary input
7	Fieldbus	External synchronization via fieldbus
8	Ethernet NTP	External synchronization via Ethernet NTP
9	GPS	External synchronization via GPS
10	Internal clock or timing master	Only for devices with a digital communication line: Same as No. 1 to 9 above, but the time is synchronized by the absolute time master as a rule. Only in case the protection data communication with the absolute time master fails, the synchronization is done via the specified source.
11	IEC 60870-5-103 or timing master	
12	Time telegram IRIG B or timing master	
13	Time telegram DCF77 or timing master	
14	Time telegram Sync.-Box or timing master	
15	Minute pulse via binary input or timing master	
16	Field bus or timing master	

Thanks to the internal buffer battery the RTC continues to run even if the auxiliary voltage is switched off temporarily. RTC is always the first synchronization source for the internal time setup when the device is switched on or after a failure of the auxiliary voltage regardless of the set operating mode.

In the operating mode Internal Clock the internal time setup uses only RTC as the synchronization source. It can also be changed manually. The manual setting of date and time is described in section 6.5.1.

If one of the external operating modes is selected, only the parameterized synchronization source will be used. If it fails, the internal clock will continue in unsynchronized mode.

If time synchronization is to be via the control system, the option **IEC 60870-5-103** or **PROFIBUS FMS** must be selected (see Figure 5-80).

For the operating modes with time signal (radio clock) it may take up to 3 minutes after the start or return of the reception until the received time has been safely decoded. Only then is the internal time setup synchronized again.

In IRIG B the year has to be set manually because this standard does not include a year value. **Note:** If a year value lower than "1991" is set by mistake in IRIG B, the year is reset to "1991" during the first synchronization.

In the case of synchronization by means of a pulse via binary input, the current device time is set forward to the 0-th second of the next minute when the current second time is higher than 30 seconds when the positive edge of the pulse arrives. If the second time is lower, the 0-th second of the current minute is used. Monitoring of the signal is not carried out, every pulse acts directly on the time setup.

Set one of the options with the supplement „... or timing master“ (No. 8 to 14 in Table 5-1) for the device(s) whose time is synchronized by the absolute time master. The device will then use the defined source only if it does not get any time from the absolute time master.

Synchronization Offset

The parameter "Synchronization offset" (**Offset to time signal**) can be used to adapt the synchronization time delivered by the radio clock receiver to the local time (time zone). The maximum offset which can be set amounts to: 23 h 59 min = 1439 min.

Fault Indication after Tolerance Time

The tolerance time for faults (Fault indication after) indicates how long a cyclic synchronization may be missing until the time is considered faulted.

An external or internal synchronization is usually performed in minute intervals. (The synchronization by external pulse via binary input is an exception. Its pulse may arrive in intervals of several minutes). Therefore, this parameter must always be at least 2 minutes. If the conditions for reception are unfavorable for the radio clock, the transition to the state "error" can be further delayed.

Changing the Operating Mode

When changing the operating mode, the corresponding hardware will switch to the other synchronization source after one second at latest. The cyclic synchronization is then initially lost and the time is regarded as faulty, as during a startup, until the new synchronization source takes over the task.

If the synchronization offset is changed in the operating modes with time signal and if the year is changed in the operating mode IRIG B, the cyclic synchronization will not be lost but a time step will occur. In order to draw your attention to this fact the time value is signaled with Fault Clock ON without the synchronization offset and then with Fault Clock OFF with the synchronization offset when the offset changes to the "jumping" minute of the time value.

Operational Indications of the Time Setup

After the **Fault Clock ON** indication the time may jump. This indication is triggered in the following cases:

- a synchronization fault has lasted for longer than the above mentioned tolerance time or by changing the operating mode.
- If a time jump is due afterwards. The indication is still indicated with the time before the jump.

The **Fault Clock OFF** is triggered in the following cases:

- When the synchronization functions again (for example after a receipt fault in case of radio clock receipt),
- Immediately after a time jump. This indication is displayed with the time after the jump so that the magnitude of the jump can be concluded.

Time Format

Either the European time format (dd.mm.yy), the US format (mm/dd/yy), or the format yy-mm-dd can be specified for the device display.

5.17 Setting Further Parameters

Additional objects can also be found in the operator tree of the DIGSI 4 Gerätebearbeitung, depending on the device type and specified functional scope. These objects each contain settings whose setting values apply to the current SIPROTEC 4 device, independent of a specific settings group. These are the following objects:

- ❑ **Power system data**
This object contains system-specific settings, such as phase sequence or network frequency.
- ❑ **Device**
This object contains special device-specific settings, such as fault display at the LEDs.
- ❑ **Fault recording**
This object contains settings whose setting values influence the recording of a fault record.
- ❑ **Measuring transducers**
This object is a container and contains additional objects. Each of these additional object represents a transducer block (see chapter 5.11).
- ❑ **Synchronization**
This object is a container and contains additional objects. Each of these additional objects represents a synchronization block or a field setting block.

Setting Parameters

- Double-click the object. If dealing with a container, repeat this process with one of the contained objects. A dialog box opens that lets you specify the settings. Enter the parameter settings of your system.

5.18 Editing Parameter Settings in Settings Groups

In order to edit parameter settings combined into settings group first open an overview of the existing functions.

Proceed as follows:

- Double-click for example on **Setting Group A**.

The **Setting Group** dialog box is displayed.

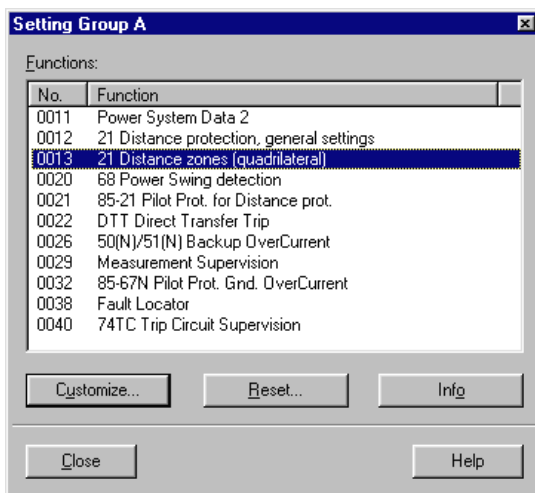

DIGSIB130

Fig. 5-81 **Setting Group** dialog box

The functions are displayed with their function number. The type and scope depend on the specified functional scope.

Resetting a Settings Group

- If you want to reset all the parameter values of the settings group, click the **Reset** command button.

Function-specific Information

- If you require further information on a function, select it and click on the **Info** command button.

Access to Parameters

Proceed as follows in order to configure the functions of the settings group:

- Select the function and click **Customize**.

A dialog box for setting the parameter settings is opened. These are combined into the following tabs depending on the type and number of the parameters:

Tab for text and decimal parameters

For specifying individual setting values. A setting value is selected from a drop-down list box or entered as a number.

Tab for table parameters

For displaying and changing values of a user-defined characteristic

- Carry out your changes.
- Click **Apply** to accept changes. The command button is active as soon as you have changed at least one setting value. The dialog box remains opened.
- Click the **DIGSI > Device** command button to transfer the modified setting values to the SIPROTEC 4 device. If you work in the **Online** mode, the **DIGSI > Device** command button is active as soon as a setting value has been changed.
- Click **OK** to accept your changes.



NOTE

The values are only placed in the memory of the computer. The setting values are **not yet** stored in the parameter set. They are only saved to the memory of the computer.
For information on saving the changed settings please refer to chapter 4.4.

Exporting Setting Values

If setting values can be exported, the **Export** command button is active. The data export is described in chapter 4.7.1.

5.18.1 Editing Text and Decimal Parameters

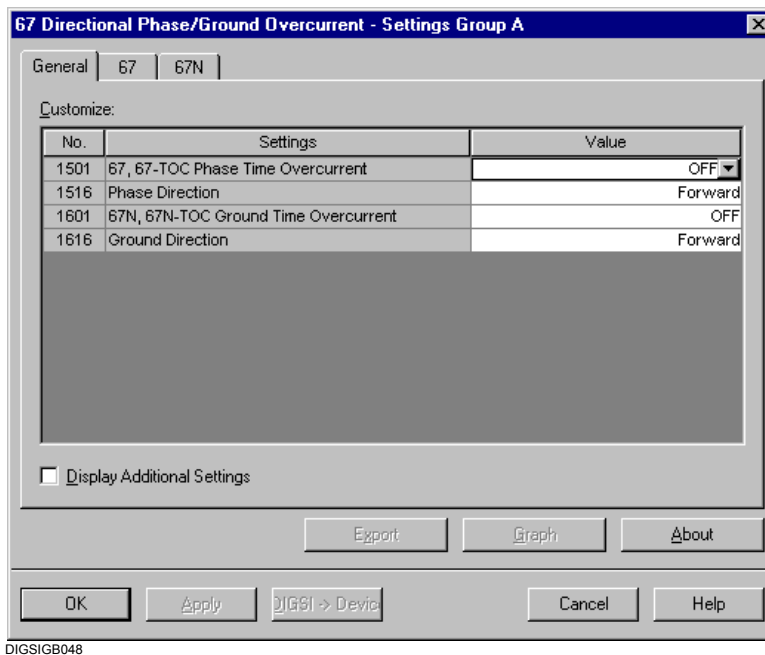

DIGSIGB048

Fig. 5-82 Function settings, tab type for text and decimal parameters

- ❑ **Parameter number**
For identifying the parameter and its description in the device documentation.
- ❑ **Parameter**
Long text designation of the parameter, only the short text is displayed in the display of a SIPROTEC 4 device.
- ❑ **Value**
Set parameter value. Can be changed, depending on the parameter type, as a text parameter ON, OFF, etc. via a drop-down list box or by entering the value directly in the **Value** box.

Range of Values

- Place the cursor in the **Value** column in the corresponding field. The permitted range of values is then displayed for some seconds as a tooltip.



NOTE

For some parameters the setting value **infinite** is also permissible. For this, enter the value **oo**.

Selecting the Input and Display Mode

Setting values can be entered and displayed as primary or secondary values.

- To do so, first close all the dialog boxes. Then click **Options > Primary parameter** or **Options > Secondary parameter** in order to select the respective mode. Open the required dialog boxes again.

Displaying Additional Settings

If the **Display Additional Settings** check box is active, additional settings are active which can, as a rule, be left at their default settings.



NOTE

The parameters set in the **Advanced** area are factory-preset and should only be changed by an experienced user.

5.18.2 Editing Table Parameters

As a rule a table parameter describes a user-defined characteristic.

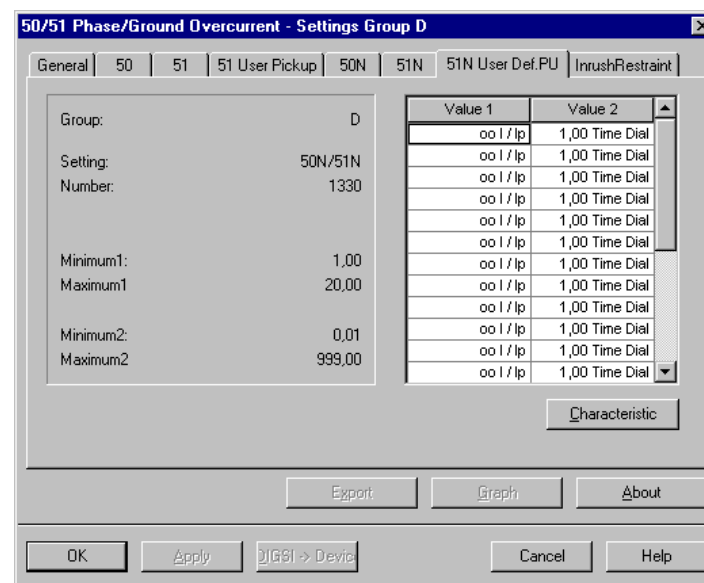

DIGSIB050

Fig. 5-83 Function settings, tab type for table parameters

A characteristic is defined by a series of pairs of values. These value pairs together form the setting value of the parameter. This type of parameter is called a table parameter. The fields in the columns Value 1 and Value 2 are used to enter the characteristic values.

A user-defined characteristic is valid for all settings groups. This characteristic can be displayed graphically and edited with the mouse (see chapter 5.19).

The dialog box contains data for the selected characteristic on

- The number of the current parameter
- Minimum and maximum value for the values on the X axis (Value 1) and
- Minimum and maximum value for the values on the Y axis (Value 2).

Further information can be found by pressing the **About** command button.

- Double-click in one of the columns **Value 1** or **Value 2** on the value that you want to change. The cursor changes to a text cursor. Enter the value and press the Return key.

5.19 Working with User-defined Characteristics

You can display graphically your projected user-defined characteristics and edit them with the mouse.

Proceed as follows:

- Open your SIPROTEC 4 device and double-click a **Settings Group** in the function selection. The dialog box with the configured functions of the settings group is opened.

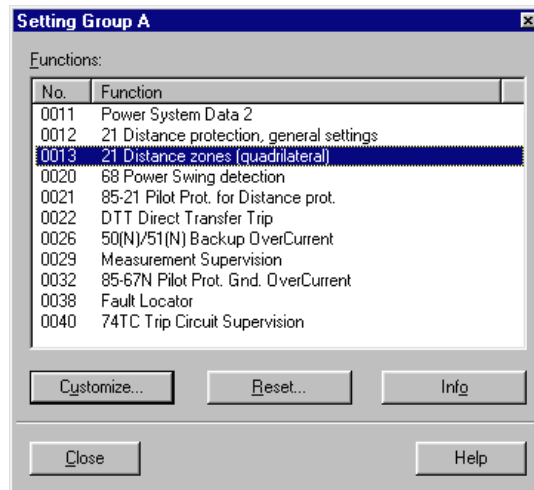

DIGSIB130

Fig. 5-84 Setting Group A

- Double-click the names of an overcurrent time protection function, i.e. for example on **directional DMT/IDMTL**. The dialog box with the corresponding setting values is opened. Click the tab in which your characteristics are displayed.

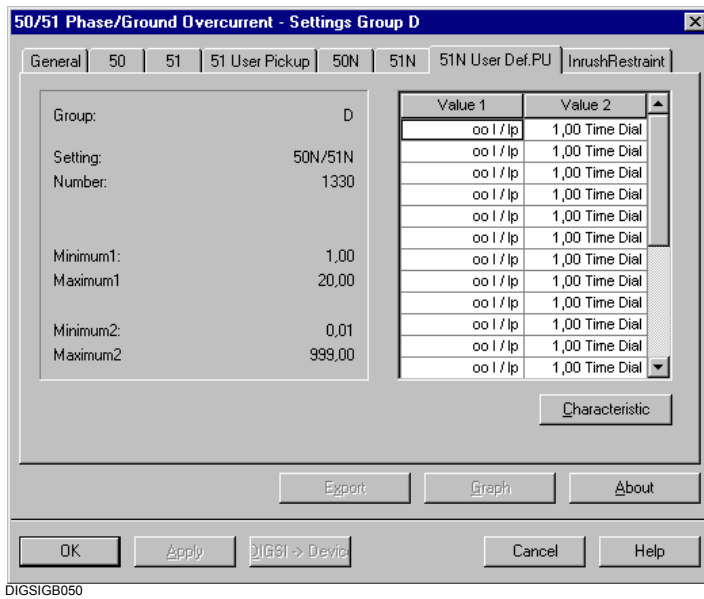

DIGSIGB050

Fig. 5-85 Setting parameter values of the table parameter type

- Click the **Characteristic** command button.

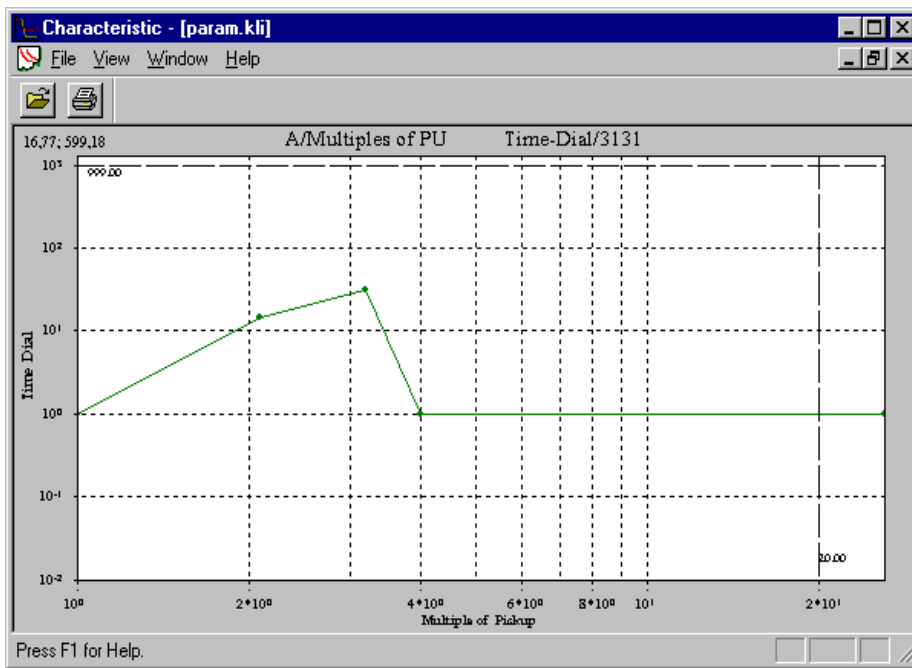

DIGSIGB051

Fig. 5-86 Characteristic

5.19.1 Changing the Characteristic Course

The course of the characteristic can be changed numerically or graphically.

Changing Numerically

- Click the value in the dialog box in which the values are displayed in table form and enter the new value.
- Click **Characteristic**. The displayed characteristic course is updated.

Changing Graphically

- Position the cursor on a data point of the characteristic. The cursor changes to the shape of a hand. Press the left-hand mouse button and drag the data point while keeping the mouse button pressed to the desired new position and release the mouse button.

The value in the value table is updated.

The upper limits of the value ranges are shown by dotted lines at the top and right extremes of the coordinate system. If the position of a data point lies outside these limits, the associated value will be set to infinity.

5.20 Using Zone Diagrams

The zone diagram is a graphic display of the zone characteristics for distance/impedance protection. As an additional information, fault locations recorded in fault record files can also be displayed.

The distance protection function has to be configured in the functional scope of the SIPROTEC 4 device.

Proceed as follows in order to display the zone diagram:

- Select **View > Trip Characteristic**. A maximum of four settings groups are displayed in the submenu. If none of the designations displayed is active, no distance protection functionality is configured for the SIPROTEC 4 device. If fewer than four settings groups can be selected, either the setting group changeover is configured as **Disabled** or the processed SIPROTEC 4 device supports less than four settings groups.
- Select the settings group for which you want a zone diagram to be displayed. The zone diagram is displayed in its own window.

Proceed as follows in order to display fault locations recorded in a fault record file in the zone diagram:

- Open the fault record file, select **View > Trip Characteristic** and then select the settings group.
The zone diagram is displayed in its own window.

Proceed as follows if you do not want to display fault locations:

- Open any dialog box for setting parameter values. Click **Graph** inside this dialog box. The zone diagram is displayed in its own window.

Closing a Zone Diagram

- Click **OK** in order to close the zone diagram.

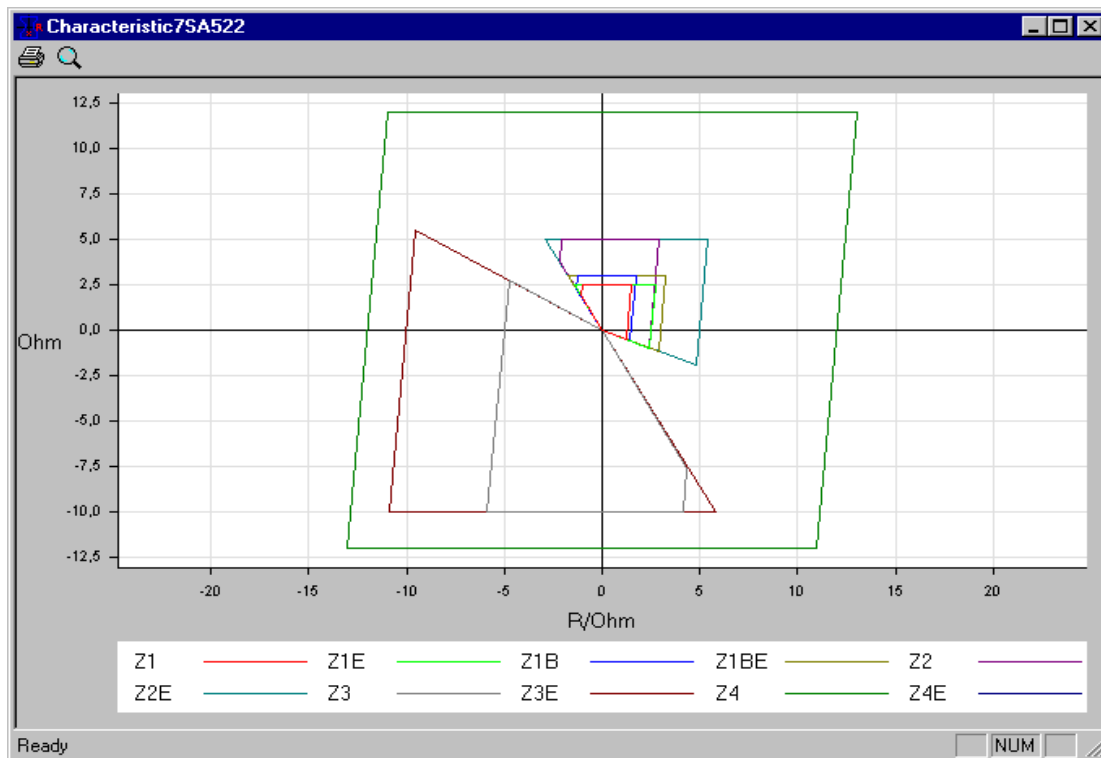

DIGSIB065.tif

Fig. 5-87 Zone diagram

Hiding and Displaying Zones

On opening the window, all available zones are displayed. Proceed as follows in order to hide or display a zone:

- Click in the display area and click **Signals** in the context menu. A further context menu is displayed in which all the zones currently displayed are identified by a check mark. Click the name of the zone that you want to hide/show. The corresponding entry in the legend is also hidden or displayed.

Increasing and Reducing the View

The size of the zone diagram is automatically adapted to the size of the window. The zoom function enables magnification of any area of the zone diagram.

- Click the **Zoom** command button in the toolbar. The cursor changes to a magnifying glass.
- Position the cursor on the upper left-hand corner of the area which you want to zoom, keep the left mouse button pressed, drag a rectangle around the area and release the mouse button.
- Click the magnifying glass in order to de-activate the zoom function. The cursor returns to its original form.

5.21 Setting the Order of Fault Indications

You can set the order of fault indications displayed on the SIPROTEC device (see chapter 6.2.3) according to your priorities by selecting a specific type of indication for each of the first six lines. You may, however, also define that no indication is to be displayed within one line.



NOTE

The allocation of a special indication to a certain selected type of indication is defined in the parameter set. It cannot be changed by you. Therefore, user-defined indications will not be displayed after a fault.

To set the display order of fault indications:

- Open the device matrix or go to it if it is already open.
- Click Options> Display after fault on the menu bar of the device matrix. This menu command is only active if the two conditions mentioned above are fulfilled. The dialog box **Display after fault** opens.
- Select a type of indication for each display line by means of the dropdown list boxes in the column "Type". If display of an indication is to be suppressed in a certain line, select the setting "None" for this line.
- Click **OK** to apply your settings and to close the dialog box. The setting has only been accepted in the memory of the computer. The setting is not yet stored in the parameter set.



Control during Operation

This chapter describes the control process with a SIPROTEC device during operation. You are provided with information on how you

- ❑ Can read out information from the device
- ❑ Can influence the functions of the device during operation and
- ❑ Can control your plant via the device.

More precise information on the function of the device is not required. However, it is assumed that you have already carried out the device configuration in accordance with Chapter 5, in particular the configuration of the input and output functions.

Please note that the examples used have been kept general and can differ in wording or details from the device at hand. Depending on the model variant some of the functions discussed may not be available. Please refer to your device documentation for information on the process data which can be processed by your device.

Contents

6.1	Reading All the Process Data from the Device	304
6.2	Indications	305
6.3	Measured and Metered Values	325
6.4	Fault Recording Data	333
6.5	Controlling Device Functions	337
6.6	Circuit Breaker Test Function	348
6.7	Control of Switchgear	352

6.1 Reading All the Process Data from the Device

The device provides a great deal of information for local retrieval or for data transmission:

- Indications,
- Operational measured values and metered values,
- Fault recording data.

These **items of information** can **all** be read out **together in one step** from the device memory via DIGSI 4. To do this, you only require an empty project.

Proceed as follows:

- Select in DIGSI 4 Manager the device from which current process data are to be read out.
- Select in the context menu **Read out process data**.



NOTE

If the device is not available on your PC, the data (settings and process data) can be read out by Plug and Play (see Chapter 7.2).

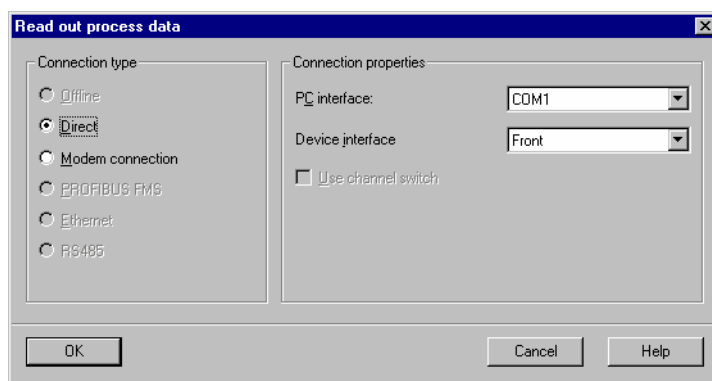

DIGSIMAN066

Fig. 6-1 Reading out process data

- Select the desired connection type, set the connection properties and click OK to start the transfer.

The process data, the indication and measured-value lists and the fault records are transferred to your PC. There they can be evaluated directly or exported.

6.2 Indications

Indications inform the user during operation of measured data, station data and of the status of the device itself. After a fault in the power system, they also provide an overview of important data concerning the fault and the device function, and are used to verify functional procedures during testing and commissioning. Indications can be transferred spontaneously or during a general interrogation. They are provided with a time stamp at the instant of arrival.

The indications are structured in indication groups and can be read out via the display at the operator control panel of the device or with DIGSI 4 to a PC.



NOTE

The complete list of all the indication and output functions which can be generated in the device are listed together with the corresponding information number FNo. in the appendix of your device manual.



NOTE

A password entry is not required in order to read out indications from the device.

6.2.1 Basic Information on Reading Out Indications

In order to read out individual indications or indication groups of your SIPROTEC 4 device you can use the **operator control panel** on the front of the device or a PC on which you have installed **DIGSI 4**. The following section describes the general procedure.

Reading Out at the Operator Control Panel

Proceed as follows in order to read out the indications via the operator control panel of the SIPROTEC 4 device:

- While the device is ready to operate select the **MAIN MENU**.

All the menus and indication lists begin with a header.

The number in the upper right corner of the display specifies how many menu entries or indications follow.

The number before the slash indicates which indication or menu entry you have just selected or is being displayed (see Fig. 6-2, first line respectively).

- Use the paging keys to navigate to the desired indication group, for example Event Log.

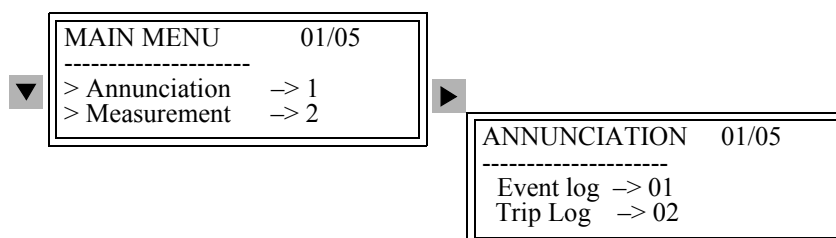

Fig. 6-2 Reading out indications on the device front - example

Reading Out with DIGSI 4

In order to read out the indications with DIGSI 4, connect your PC to the **operator interface** or to the **service interface** of the device. The service interface is usually used when the PC has a fixed connection to several devices by means of a data bus or modem.

The type and scope of the indication display depend on the current mode and on the assignments in the configuration matrix.

Proceed as follows:

- Open the device.
- Double-click in the navigation window on **Annunciation**.
- Double-click **Event Log**.

The indications are displayed in the data pane.

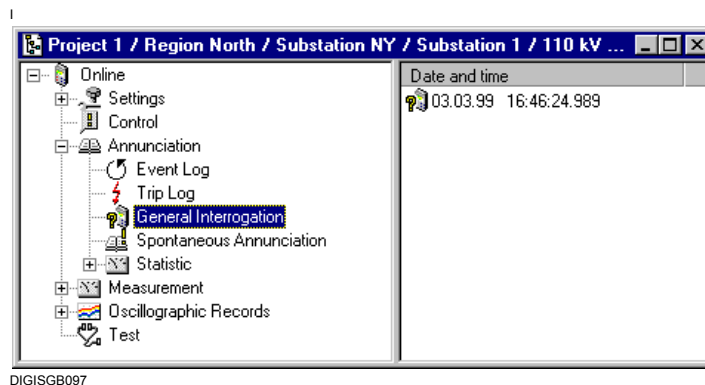

Fig. 6-3 Selected process data set

Offline Mode

If you are working in the **Offline** mode, you can display the **process data saved** in the permanent memory of your PC.

Online Mode

If you are working in the **Online** mode, the **current process data** from the permanent memory of the SIPROTEC device is displayed.

The information is read out of the device, displayed in the data pane and stored in the temporary memory of your PC. Information already saved in the permanent memory of the PC is not affected (see Chapter 4.4).

Data in the indication memories of the device is **not** deleted by being read out to the PC. The indication memories can be deleted explicitly via operation (see Chapter 6.2.7).

Updating the Display

In the **Online** mode **spontaneous indications** are transferred **automatically** from the device to your DIGSI 4 PC as soon as they arrive. The active indication window is updated.

The display of **Event Log**, **Trip Log** and **General Interrogation** can be updated **manually** in the **Online** mode.

- Click on the indication window and select **View > Update**. The indications of the displayed indication group are transferred from the device to your DIGSI 4 PC. The display is updated.

One process data set is displayed for each type of information with the exception of **fault indications** and **ground-fault indications** where 0 to n process data sets can be displayed.



NOTE

DIGSI 4 allows you to display different types of information simultaneously in different windows (see Chapter 4.2.7).

Display of Indications

The indications are supplemented by the following information:

Event Log:	Date and time
Trip Log:	Network fault number, date, and time
Sensitive Ground Fault Log:	Number, date, and time
General Interrogation:	Date and time
Spontaneous Annunciation:	Date and time

The message line contains the cause of the transmission in abbreviated form in the **Initiator** column. If the cause is negative, an additional cause is also displayed in plain text, such as **Configuration fault**. In addition the information in the **State** column indicates whether the input blocking **IB** or the chatter blocking **CB** is activated.

SPN	Spontaneous
GI	General Interrogation
CA+	Command acceptance positive
CA-	Command acceptance negative
FB+	Command feedback positive
FB-	Command feedback negative
ZWI	Command feedback intermediate position
AB+	Abort execution positive
AB-	Abort execution negative
COE	Command execution end
FPL	Enable request

In addition the **initiator category** is displayed.

VQ = Local	Local operation
VQ = SICAM	On-site operation
VQ = Remote	Remote operation
VQ = Auto SICAM	Automatic (internally from CFC in the Substation Controller)
VQ = Auto	Automatic (locally from the field level)
VQ = DIGSI	DIGSI
VQ = Error	Field device internal, invalid
VQ = Blocked	Field device internal, blocked

6.2.2 Event Log (Operational Indications)

Operational indications are items of information which the device generates during operation and about the operation. This includes information on the state of the device functions, measured data, plant data, etc.

More than 100 operational indications are saved in the device in chronological order. Newly generated indications are added to those already there. If the maximum capacity of the memory is exhausted, the oldest indication is lost.

Positive and negative exceeding of **limits** is output as an operational indication. Limits can be changed during operation (see Chapter 6.3.3)

Short-circuits in the network are specified as a **network fault** operational indication with sequential fault number. Detailed information on the course of the network faults is contained in the **EVENT LOG** indication group. (see Chapter 6.2.3).

Ground faults are specified at devices with ground-fault detection as an **ground fault** operational indication and a sequential ground-fault number.

Detailed information on the course of the ground faults is contained in the **SENSITIVE GROUND FAULT LOG** (see Chapter 6.2.4).



NOTE

All the available operational indications are listed in table form and explained in the appendix of your device manual.

The information is specified for each indication whether it is

- An event (only on ON) or
- A state (on and off ON/OFF).

From the Device Front

- Use the paging keys to navigate to the **Event Log menu item**.
The **EVENT LOG** table is displayed.

The events and state changes are listed there in chronological order. The most recent indication with the date and time of the indication is displayed.

The end of the entries is identified by **End**.

If there are no indications, the text **List is empty** is displayed.

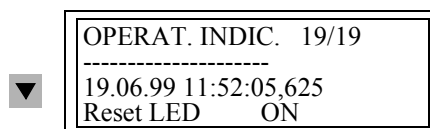

Fig. 6-4 Example of an operational indication on the front

- Use the paging keys to have the individual operational indications displayed.
- Use the **MENU** key to return to the **MAIN MENU**.

From PC with DIGSI 4

Proceed as follows:

- Double-click in the navigation window under **Annunciation** on **Event Log**.

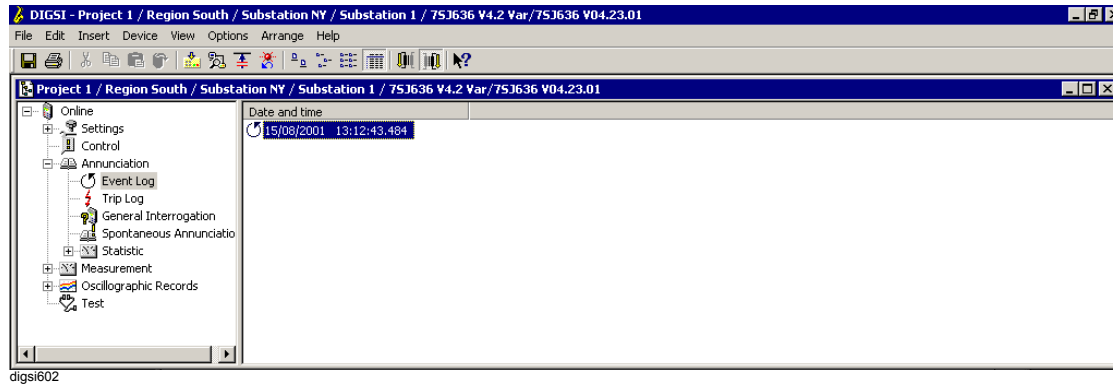

Fig. 6-5 DIGSI 4 Selection of operational indications, example

- Double-click in the data pane on an entry.

All the indications of the indication group are displayed with their current value in the **Event Log** window.

The screenshot shows the DIGSI 4 Event Log window. The title bar reads 'DIGSI - Event Log - 15/08/2001 - Project 1 / Region South / Substation NY / Substation 1 / 75J636 V4.2 Var/75J6'. The menu bar includes File, Edit, Paste, Device, View, Options, Arrange, and Help. The main window displays a table of operational indications.

Number	Indication	Value	Date and time	Initiator	Cause	State	Add. Cause
160	Alarm Summary Event	ON	15.08.2001 12:46:33.874	Com.Issued=Aut...	Spontaneous		
167	Failure: Voltage Balance	ON	15.08.2001 12:46:33.874	Com.Issued=Aut...	Spontaneous		
068	Clock Synchronization Error	OFF	15.08.2001 12:46:25.008	Com.Issued=Aut...	Spontaneous		
269	Supervision Temperature	ON	15.08.2001 12:46:24.635	Com.Issued=Aut...	Spontaneous		
270	Set Point Pressure	ON	15.08.2001 12:46:24.635	Com.Issued=Aut...	Spontaneous		
268	Supervision Pressure	ON	15.08.2001 12:46:24.634	Com.Issued=Aut...	Spontaneous		
284	Set Point I alarm	ON	15.08.2001 12:46:24.628	Com.Issued=Aut...	Spontaneous		
758	Time Overcurrent Earth is ACTIVE	ON	15.08.2001 12:46:24.190	Com.Issued=Aut...	Spontaneous		
753	Time Overcurrent Phase is ACTIVE	ON	15.08.2001 12:46:24.190	Com.Issued=Aut...	Spontaneous		
052	At Least 1 Protection Funct. is Active	ON	15.08.2001 12:46:24.190		Spontaneous		
051	Device is Operational and Protecting	ON	15.08.2001 12:46:22.789		Spontaneous		
	>Cabinet door open	ON	15.08.2001 12:46:22.745	Com.Issued=Aut...	Spontaneous		
	>CB waiting for Spring charged	ON	15.08.2001 12:46:22.745	Com.Issued=Aut...	Spontaneous		
656	Dir. time overcurrent EARTH is OFF	ON	15.08.2001 12:46:22.741	Com.Issued=Aut...	Spontaneous		
651	Dir. time overcurrent PHASE is OFF	ON	15.08.2001 12:46:22.741	Com.Issued=Aut...	Spontaneous		
147	Phase Rotation L1L2L3	ON	15.08.2001 12:46:22.741	Com.Issued=Aut...	Spontaneous		
056	Initial Start of Device	ON	15.08.2001 12:46:22.646		Spontaneous		
055	Reset Device	ON	15.08.2001 12:46:22.646		Spontaneous		

Fig. 6-6 DIGSI 4 Operational indications, example

6.2.3 Trip Log (Fault Indications)

Fault indications are indications of the last 8 network faults which were processed by the device.

Spontaneous Displays

After a fault, the most important data of the fault is displayed automatically without any further operating actions in the displayed sequence after a general device pickup.

Dis. Pickup L12	Protection function that picked up, e.g. distance protection, with phase information
Dis. Trip L123	Protection function that is triggered, e.g. 3-pole distance protection
PU Time 93 ms Trip Time 25 ms	Elapsed time from general device pickup until drop-out Elapsed time from general device pickup until first trip command
d =	Fault distance d in km or miles

Fig. 6-7 Spontaneous indications in the device display — example

- Press the **LED** key in order to acknowledge spontaneous indications. The default display is shown after the acknowledgement.

Options for Fault Location

Depending on the device variant and configuration, there are other possibilities for displaying the fault location other than the display and DIGSI 4.

- If the device has a BCD output for the fault location and the corresponding binary outputs have been configured and are transferred to a suitable display panel with a BCD decoder, you can read out the fault location there as a percentage of the line length after a fault has occurred. The numbers have the following meaning:

0 to 195	The calculated fault location as a percentage of the line length (if greater than 100%, the error lies outside the protected line in a forward direction)
197	A negative fault location has been calculated (error not on the protected line, but in the reverse direction)
199	Overflow (the calculated value lies higher than the maximum transferable one of 195%)

If the device has at least one analog output, the fault location is output via it and is transferred to a suitable display panel, you can read the fault distance directly there after a fault.



NOTE

Note that in all the cases, the calculated fault distance can only apply for homogeneous lines and only for faults which occur on the protected line of this type. In other cases considerable distortions, for example by intermediate infeeds, can occur.

Retrievable Indications

In addition to the spontaneous display of network faults you can read out the indications of the last eight network faults.

In accordance with the definition of a network fault, a short-circuit process is regarded as a network fault until it has been finally cleared. In the case of applications with automatic re-activating, the network fault ends after the last blocking period has expired, i.e. after successful or unsuccessful re-activating. This means that the complete clearing process including re-activating cycles use only one network fault log. Several faults can occur within a network fault from the first pickup of a protection function until the drop-out of the last pickup. Without re-activation each fault is an own network fault.

If the number of fault indications exceeds the maximum size of the indication memory, the oldest sequential indication is deleted.

The appendix of the device manual display and explains all the available fault indications in table form.

From the Device Front

- Use the paging keys to navigate to the **Trip Log menu item**.
The **TRIP LOG** table is displayed. If there are no indications, the table is empty.

The indications are listed chronologically and numbered sequentially within a network fault, from the oldest one to the youngest one.

The beginning of the network fault is identified by the data and time in hours, minutes and seconds (with resolution in ms).

The subsequent single indications are provided with a relative time, referenced to the beginning of the network fault. At least one complete single indication is always displayed in the display.

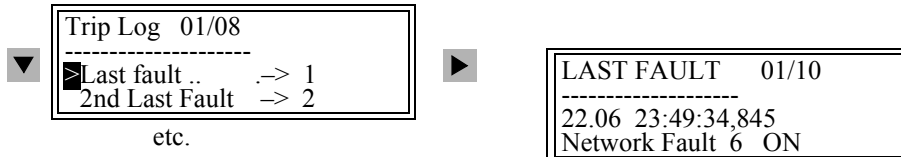

Fig. 6-8 Example of fault indications in the front display

- Use the paging keys to have the individual fault indications displayed.
- Use the **MENU** key to return to the **MAIN MENU**.

From PC with DIGSI 4

Proceed as follows:

- Double-click in the navigation window under **Annunciation on Trip Log**.

A list of the network faults is displayed in the data pane.

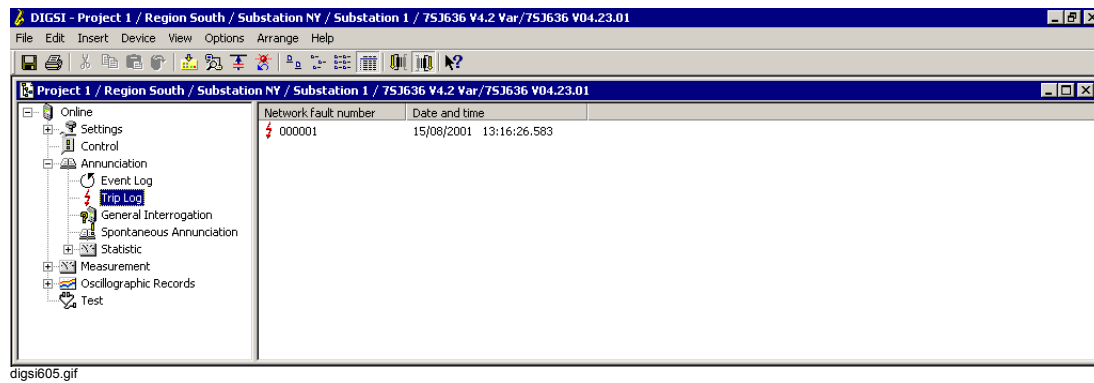

Fig. 6-9 DIGSI 4 Selection of fault indications, example

- Double-click on an entry.

The indications of the network fault are displayed in the **Trip Log** window. The entries are listed chronologically by the date and time. The latest indication is displayed first.

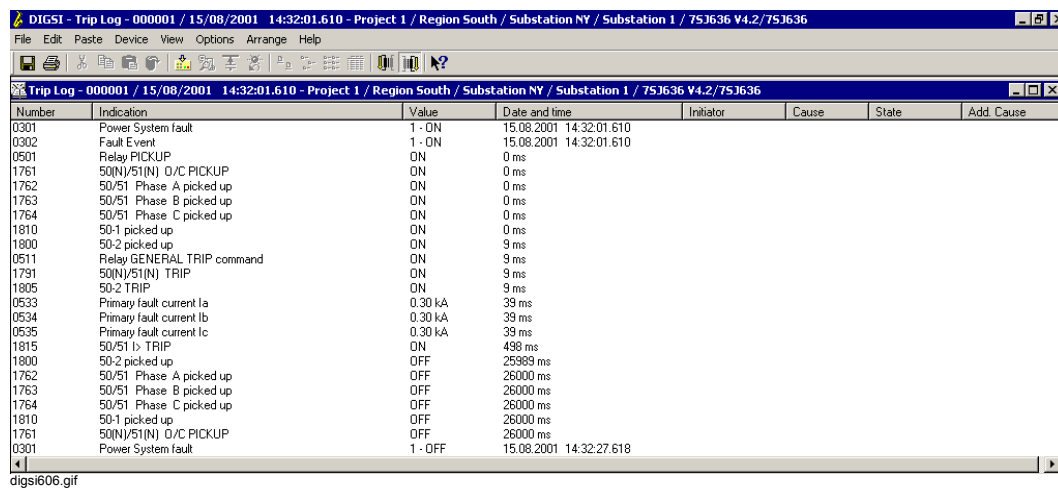

Fig. 6-10 DIGSI 4 Fault indications, example

6.2.4 Sensitive Ground Fault Log (Ground-fault Indications)

Special ground fault logs are available at devices with sensitive ground-fault detection. These are created when

- The ground-fault detection is not set to resolution but to **Indication only** and
- The ground fault is present long enough for the configured pickup delay to have expired.



NOTE

All the available ground-fault indications are listed in table form and explained in the appendix of your device manual. In a specific case only the respective indications are naturally displayed.

From the Device Front

- Use the paging keys to navigate to the **Sensitive Ground Fault menu item**. The **SENSITIVE GROUND FAULT LOG** table is displayed. If there are no indications, the table is empty.

The indications within an ground-fault log are listed chronologically and numbered sequentially, from the oldest one to the youngest one.

The beginning of the ground fault is identified by the date (without year) and time in hours, minutes and seconds resolution in ms).



Fig. 6-11 Example of an ground-fault log in the front display

- Use the paging keys to have the individual indications displayed.
- Use the **MENU** key to return to the **MAIN MENU**.

In this menu you can select the indications of the last 3 ground faults.

From PC with DIGSI 4

Proceed as follows:

- Double-click in the navigation window under **Annunciation on Sensitive Ground Fault Log**.

A list of the ground faults is displayed in the data pane.

- Double-click on an entry in the list.
- The ground fault log is displayed in the ground fault indications window.

Number	Indication	Value	Date and time	Initiator	Cause	State	Add. Cause
0303	sensitive Ground fault	1 - ON	15.08.2001 14:35:07.278				
1272	Sensitive Ground fault picked up in Ph A	ON	0 ms				
1277	Sensitive Gnd fault in reverse direction	ON	0 ms				

digsi632.gif

Fig. 6-12 DIGSI 4 Sensitive ground fault log, example

6.2.5 General Interrogation

From PC with DIGSI 4

In order to sample the current state of your SIPROTEC device, you can read out all the general-interrogation-specific indications from the device memory by means of DIGSI 4. Proceed as follows:

- Double-click in the navigation window under **Annunciation** on **General Interrogation**.
- Double-click in the data pane on the **date and time display**.

All the general-interrogation-specific indications are displayed in the General Indications windows with their current value.

Number	Indication	Value	Date and time	Initiator	Cause	State	Add. Cause
0301	Power System fault	1 - ON	15.08.2001 14:32:01.610				
0302	Fault Event	1 - ON	15.08.2001 14:32:01.610				
0501	Relay PICKUP	ON	0 ms				
1761	50(N)/51(N) O/C PICKUP	ON	0 ms				
1762	50/51 Phase A picked up	ON	0 ms				
1763	50/51 Phase B picked up	ON	0 ms				
1764	50/51 Phase C picked up	ON	0 ms				
1810	50-1 picked up	ON	0 ms				
1800	50-2 picked up	ON	9 ms				
0511	Relay GENERAL TRIP command	ON	9 ms				
1731	50(N)/51(N) TRIP	ON	9 ms				
1805	50-2 TRIP	ON	9 ms				
0533	Primary fault current Ia	0.30 kA	39 ms				
0534	Primary fault current Ib	0.30 kA	39 ms				
0535	Primary fault current Ic	0.30 kA	39 ms				
1815	50/51 I> TRIP	ON	498 ms				
1800	50-2 picked up	OFF	25989 ms				
1762	50/51 Phase A picked up	OFF	26000 ms				
1763	50/51 Phase B picked up	OFF	26000 ms				
1764	50/51 Phase C picked up	OFF	26000 ms				
1810	50-1 picked up	OFF	26000 ms				
1761	50(N)/51(N) O/C PICKUP	OFF	26000 ms				
0301	Power System fault	1 - OFF	15.08.2001 14:32:27.618				

Fig. 6-13 DIGSI 4 General indications, example

6.2.6 Spontaneous Indications

From PC with DIGSI 4

With DIGSI 4 you have the possibility of displaying the incoming current indications in the **Spontaneous Annunciation** window.

Proceed as follows:

- Double-click in the navigation window under **Annunciation** on **Spontaneous Annunciations**.
- Double-click in the data pane on the **date** and **time display**.

The incoming indications are displayed immediately without waiting for a cyclic update or triggering the manual updating.

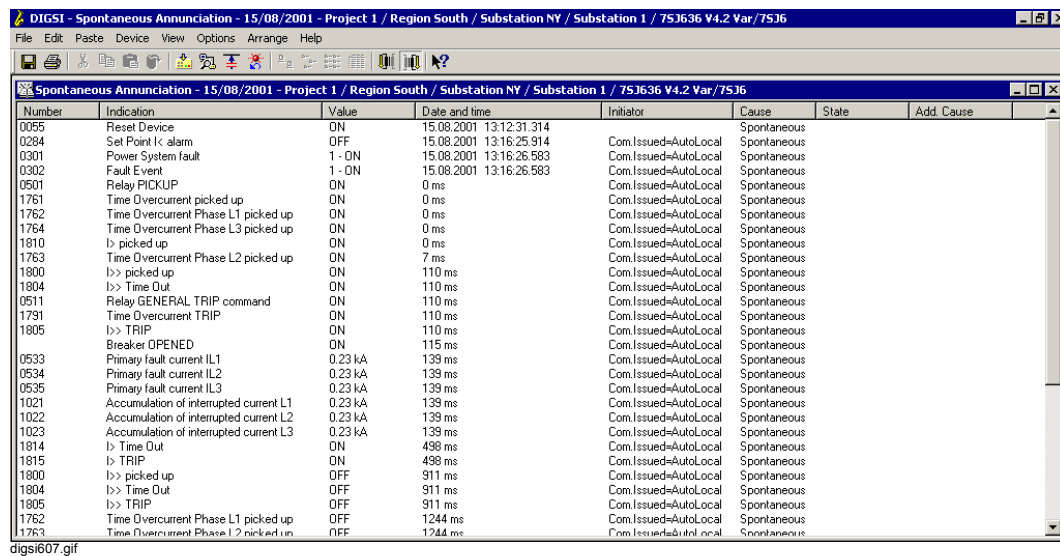

Number	Indication	Value	Date and time	Initiator	Cause	State	Add. Cause
0055	Reset Device	ON	15.08.2001 13:12:31.314		Spontaneous		
0284	Set Point k alarm	OFF	15.08.2001 13:16:25.914	Com.Issued=AutoLocal	Spontaneous		
0301	Power System fault	1 - ON	15.08.2001 13:16:26.583	Com.Issued=AutoLocal	Spontaneous		
0302	Fault Event	1 - ON	15.08.2001 13:16:26.583	Com.Issued=AutoLocal	Spontaneous		
0501	Relay PICKUP	ON	0 ms	Com.Issued=AutoLocal	Spontaneous		
1761	Time Overcurrent picked up	ON	0 ms	Com.Issued=AutoLocal	Spontaneous		
1762	Time Overcurrent Phase L1 picked up	ON	0 ms	Com.Issued=AutoLocal	Spontaneous		
1764	Time Overcurrent Phase L3 picked up	ON	0 ms	Com.Issued=AutoLocal	Spontaneous		
1810	I> picked up	ON	0 ms	Com.Issued=AutoLocal	Spontaneous		
1763	Time Overcurrent Phase L2 picked up	ON	7 ms	Com.Issued=AutoLocal	Spontaneous		
1800	I>> picked up	ON	110 ms	Com.Issued=AutoLocal	Spontaneous		
1804	I>> Time Out	ON	110 ms	Com.Issued=AutoLocal	Spontaneous		
0511	Relay GENERAL TRIP command	ON	110 ms	Com.Issued=AutoLocal	Spontaneous		
1791	Time Overcurrent TRIP	ON	110 ms	Com.Issued=AutoLocal	Spontaneous		
1805	I>> TRIP	ON	110 ms	Com.Issued=AutoLocal	Spontaneous		
	Breaker OPENED	ON	115 ms	Com.Issued=AutoLocal	Spontaneous		
0533	Primary fault current IL1	0.23 kA	139 ms	Com.Issued=AutoLocal	Spontaneous		
0534	Primary fault current IL2	0.23 kA	139 ms	Com.Issued=AutoLocal	Spontaneous		
0535	Primary fault current IL3	0.23 kA	139 ms	Com.Issued=AutoLocal	Spontaneous		
1021	Accumulation of interrupted current L1	0.23 kA	139 ms	Com.Issued=AutoLocal	Spontaneous		
1022	Accumulation of interrupted current L2	0.23 kA	139 ms	Com.Issued=AutoLocal	Spontaneous		
1023	Accumulation of interrupted current L3	0.23 kA	139 ms	Com.Issued=AutoLocal	Spontaneous		
1814	I> Time Out	ON	498 ms	Com.Issued=AutoLocal	Spontaneous		
1815	I> TRIP	ON	498 ms	Com.Issued=AutoLocal	Spontaneous		
1800	I>> picked up	OFF	911 ms	Com.Issued=AutoLocal	Spontaneous		
1804	I>> Time Out	OFF	911 ms	Com.Issued=AutoLocal	Spontaneous		
1805	I>> TRIP	OFF	911 ms	Com.Issued=AutoLocal	Spontaneous		
1762	Time Overcurrent Phase L1 picked up	OFF	1244 ms	Com.Issued=AutoLocal	Spontaneous		
1763	Time Overcurrent Phase L2 picked up	OFF	1244 ms	Com.Issued=AutoLocal	Spontaneous		

Fig. 6-14 DIGSI 4 Spontaneous annunciations, example

6.2.7 Saving and Deleting the Indication Memory

Normally the indication memory of the device does not have to be deleted during operation. When new events occur, the oldest indications are overwritten automatically, if the memory is insufficient for the new indications. However, deleting can be advisable, for example, so that the memory in future only contains information on new faults after the plant has been revised.

The memory is reset separately for the various indication groups.



NOTE

When fault indications are deleted, the corresponding fault records are also deleted. In addition, the counters for network fault numbers and fault record numbers are reset to zero. If, on the other hand, you delete fault records, the fault numbers as well as both counters are not affected.



NOTE

Before you delete indications from the device memory you should save these to the hard disk of your PC by means of DIGSI 4.

From the Device Front

Proceed as follows in order to delete indication memories:

- Use the paging keys to navigate via the ANNUNCIATION menu to the **Delete/Set** menu item.
- Select the indication group whose memory is to be deleted and press the **ENTER** key.
- Enter the passwords for parameter changes and confirm it with **ENTER**.
- Confirm the query with the **ENTER** key.

Proceed as follows if you do not want to delete the indication memories:

- Use the paging keys in the confirmation query to select the answer **No** and confirm it with **ENTER**.
Alternatively abort the deleting process by using the **ESC** key.

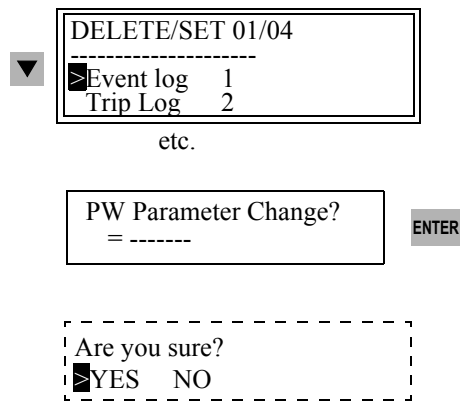

Fig. 6-15 Deleting indication memories, example of operational indications in the front display

From PC with DIGSI 4

Information which was transferred from the device to the DIGSI 4 PC for display has to be saved explicitly.

Proceed as follows:

- Open the device in the **Online** mode.
- Select an indication group and save the information by using **File > Save**.

Proceed as follows in order to delete the data in the device memories:

- Select the indication group, click in the context menu on **Delete** and confirm the confirmation query with **Yes**.

Password Prompt

If the function for deleting data in the device memories is protected by the password for individual parameters, it is prompted the first time that the delete command is to be carried out after the connection has been established.

- Enter the correct password in the **Password** box and then click **OK**.

6.2.8 Reading Out the Counters and Memories of the Switching Statistics

Indications on switching statistics are counters for:

- Switching operations of the circuit breaker initiated by the device and
- Values of the accumulated short-circuit currents in the case of disconnections initiated by protection functions of the device.

They can be read out via the operator control panel of the device and via DIGSI 4. A password input is not required.

For every trip command initiated by the protective function of the device the magnitude of the interrupted current is determined and stored for each pole. Measured values are indicated in primary values. The current magnitudes are added up in an accumulator memory.

In the case of devices with an automatic recloser the number of reclose commands is counted, separately for single-pole (if possible) and three-pole interrupt cycles, as well as separately for the first and all other reclosures.

The levels of these counted values are buffered against auxiliary voltage failure.

From the Device Front

- Use the paging keys to navigate to the **Statistics menu item**. The **STATISTICS** table is displayed.

▼	<table style="width: 100%; border-collapse: collapse;"> <tr> <td style="text-align: left;">STATISTICS</td> <td style="text-align: right;">1/08</td> </tr> <tr> <td colspan="2" style="border-top: 1px dashed black;"></td> </tr> <tr> <td>SIL1=</td> <td style="text-align: right;">0.00kA</td> </tr> <tr> <td>SIL2=</td> <td style="text-align: right;">0.00kA</td> </tr> <tr> <td colspan="2" style="text-align: center;">etc.</td> </tr> </table>	STATISTICS	1/08			SIL1=	0.00kA	SIL2=	0.00kA	etc.	
STATISTICS	1/08										
SIL1=	0.00kA										
SIL2=	0.00kA										
etc.											

Fig. 6-16 List of switching statistics, example in the front display

From PC with DIGSI 4

Double-click in the navigation window under Annunciation on Statistic.

- Double-click in the data pane on **Statistics**.

The statistical information is displayed in the **Statistic** window.

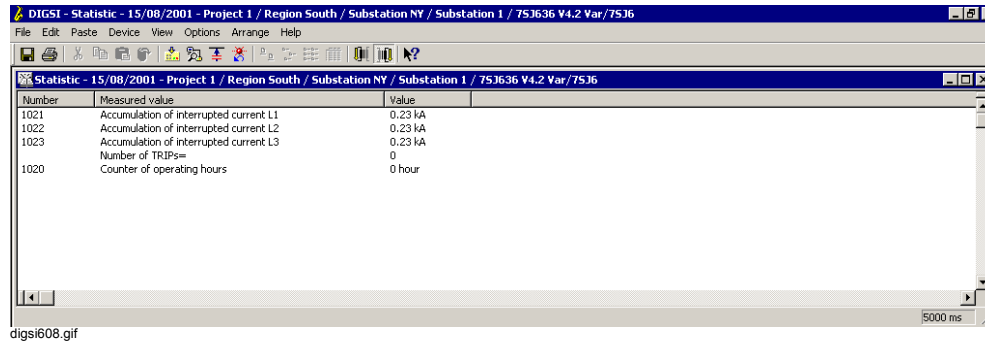

Number	Measured value	Value
1021	Accumulation of interrupted current L1	0.23 kA
1022	Accumulation of interrupted current L2	0.23 kA
1023	Accumulation of interrupted current L3	0.23 kA
	Number of TRIPs=	0
1020	Counter of operating hours	0 hour

Fig. 6-17 DIGSI 4 Statistic, example

6.2.9 Resetting and Setting the Counters and Memories of the Switching Statistics

The counters and memories of the statistics are saved by the device. Therefore the information will not get lost in case the auxiliary voltage supply fails. However, you can set the counter to zero or to any value within the setting limits.

From the Device Front

- In the **Statistics** menu select the metered value which is to be set and confirm with **ENTER**.
- Enter the password for individual parameters.
- Overwrite the numeric value in the box in which the cursor flashes and confirm your entry with **ENTER**.

If the value entered does not lie within the range of values, the corresponding maximum or minimum limit is displayed at the lower screen end.

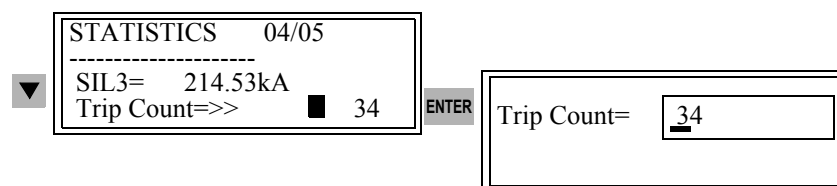
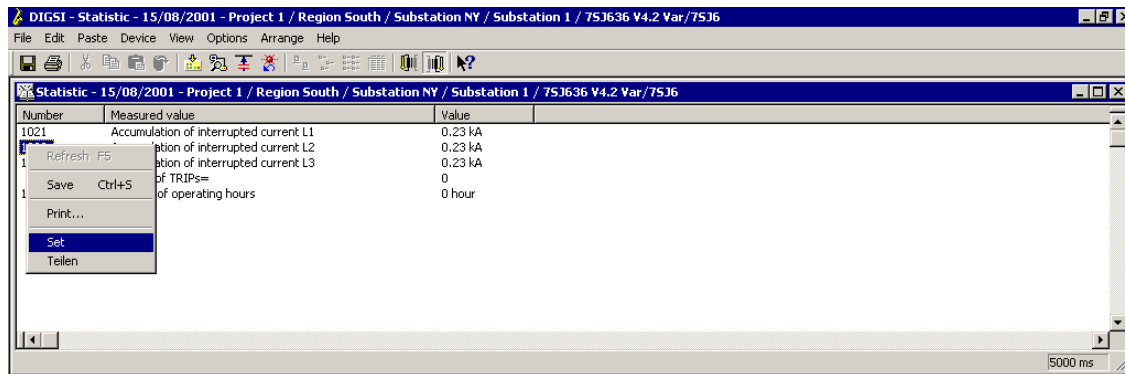

Fig. 6-18 Setting statistics counters, example

From PC with DIGSI 4

- In the **Statistic** window select the metered value and click on **Set** in the context menu.



digsii610.gif

Fig. 6-19 DIGSI 4 Setting the statistic counter

- Enter the password for individual parameters and overwrite the previous value in the **Set statistic value** dialog box

6.2.10 Resetting Indications Output on LEDs

Individual indications or group indications formed via DIGSI 4 can be displayed by means of LEDs on the operator control panel of your SIPROTEC device. The assignment is carried out by means of the configuration matrix (see Chapter 5.5.6).

The green LED called "RUN" lights permanently during fault-free operation.

The red LED called "ERROR" indicates that the processor system has recognized an internal fault. If it lights during operation, the device is not ready to operate. Chapter 8.5 provides information on how to proceed if a fault occurs.

The other LEDs on the operator control panel show the indications which have been configured to the LEDs. Their meaning should be noted on labeling strips.

The LEDs which indicate states remain lit as long as the state exists. State displays are not normally saved.

If indications configured to LEDs are stored (for example pickup of a protective function), you can delete this memory by means of the **LED** key or by means of remote control.

The key is also used to check the functionality of the LEDs. All these LEDs must light up when the key is pressed.

6.2.11 Resetting Indications Saved to Binary Outputs

The messages which are configured to binary outputs are transmitted by means of a signaling-circuit voltage. They are then usually available in an indication center.

If indications configured to binary outputs are stored, you can delete this memory by means of the **LED** key or by means of remote control.

6.2.12 Copying, Moving and Deleting Process Data

You can copy or move process data from the data of a SIPROTEC device to the data of another SIPROTEC device. This is necessary if, for example, you have read out information locally and have saved it on the permanent memory of your PC, but the data is managed centrally (also refer to Chapter 4.4).

Information can only be moved or copied within the same information type, for example operational indications to operational indications. Both SIPROTEC devices must be of the same type.

Proceed as follows:

- Open the two SIPROTEC devices between which you want to copy or move process data in the **Offline** operating mode.

Copy

- Select the data and copy the data by **Drag & Drop** or by using the **Copy** and **Paste** context menu or by using the **Copy** and **Paste** menu or by using the icons.

Move

- Move the information by using a combination of the commands **Cut** and **Paste** or by **Drag & Drop** (with pressed shift key).

Delete

All the process data visible in the **Offline** mode is stored in the permanent memory of your PC. If you delete a process data set in this mode, you therefore always delete a file in the permanent memory of the PC. You can delete process data sets individually or all the process data sets of one category together.

Proceed as follows:

- Select the information type, for example **Event Log**, select the information which you want to delete and use the **Delete** context menu to delete it.

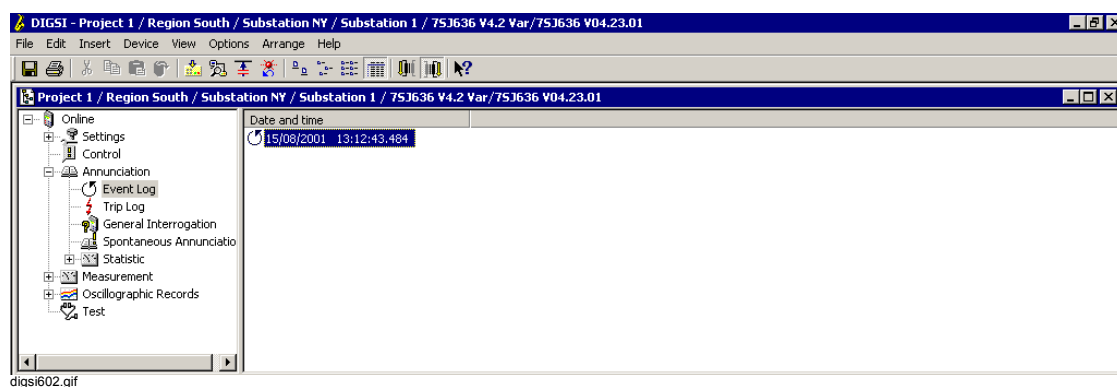
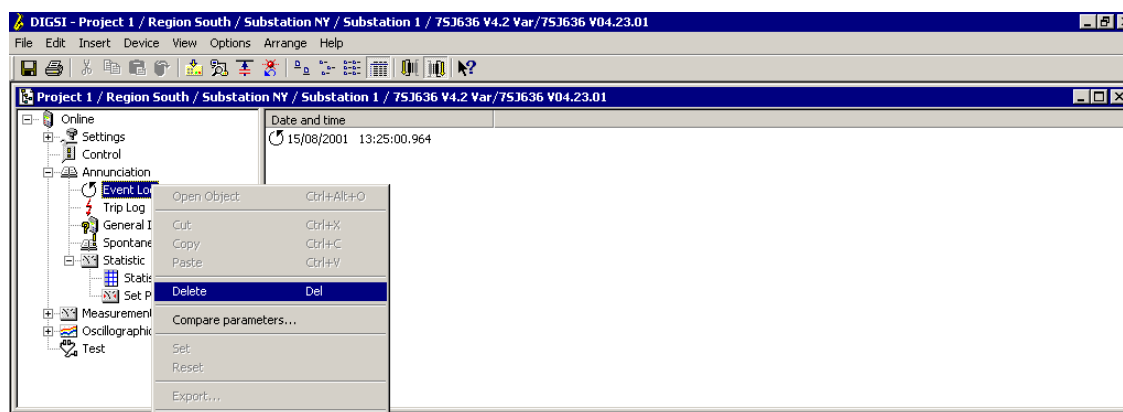

Fig. 6-20 DIGSI 4 Deleting a process data set

- Confirm the confirmation query with **Yes**.
- or
- Select the information type, for example **Event Log** and use the **Delete** context menu to delete all the information which belongs to this information type.



digsig11.gif

Fig. 6-21 DIGSI 4 Deleting process data sets of a category

- Confirm the confirmation query with **Yes**.

6.3 Measured and Metered Values

Operating measured values and metered values are determined in the background by the processor system. They can be called up at the operator control panel of the device, read out via DIGSI 4 or transmitted to a central master station via the system interface.

No password is required to read out the measured and metered values.

The display of the measured values is updated cyclically in DIGSI 4 in the **Online** mode. The cycle time is predefined and is displayed on the status bar or at the lower edge of the window. The values are updated after a few seconds on the device display.

Most measured values can be displayed in primary quantities, secondary quantities and quantities referenced to the nominal value. Prerequisite for the correct display is the correct configuration of the nominal values in the plant data. Secondary values are quantities applied to the device terminals or values calculated from these.

All the detected measured values are provided with a time stamp in the device at the instant of arrival.

At devices with a four-line display the general measured values of the feeder are shown in the display when the device is idle.

% I	ULE	ULL	
L1	100.1	102.0	102.2
L2	102.5	102.5	100.0
L3	98.7	98.7	99.8

Fig. 6-22 Example of a default display in a 4-line display

Measured Value Types

- Operational measured values**
 These include the r.m.s. values for voltage and current, frequencies and pressure values. If necessary, further values are calculated from these, for example apparent power or cos phi. They are displayed as **primary values**, **secondary values** or as **percentages** referenced to the nominal values.
- Sensitive ground-fault measured values**
 This group contains exclusively current values which are detected by sensitive ground-fault converters. They are displayed as **primary values** or as **secondary values**.
- Thermal measured values**
 This group contains measured values of the thermal overload protection. In DIGSI 4 they are saved in the **Other measured values** group.
- User-defined measured values**
 This group contains values calculated from the detected measured values. The calculation procedures are specified during the device configuration. In DIGSI 4 they are saved in the **Other measured values** group.
- Energy counters**
 Energy counters detect different types of active and reactive energy.

Minimum, Maximum and Mean Values

Minimum and maximum values of the detected measured values are saved separately. A number of different mean values are also formed.

- ❑ **Mean values**
Long-term mean values from current and power values
- ❑ **Minimum and maximum values of the mean values**
Minimum and maximum values of the long-term mean values, with date and time of their occurrence.
- ❑ **Minimum and maximum values for U and I**
Minimum and maximum values of voltages and currents, with date and time of their occurrence.
- ❑ **Minimum and maximum values for P, f and cos phi**
Minimum and maximum values for active, reactive and apparent power, frequency and the power factor



NOTE

A complete overview of the measured values which are available in your SIPROTEC device is contained in your device manual.

6.3.1 Operational Measured Values

The procedures for reading out operational measured values at the device display and via DIGSI 4 is shown using the example of the **Operational measured values primary**.

From the Device Front

- In the **MAIN MENU** select the **Measurement** menu item and change to the **MEASUREMENTS** submenu.
- There select the **Operation. pri** menu item (operational measured values primary) and change to the **OPERATION. PRI** menu.

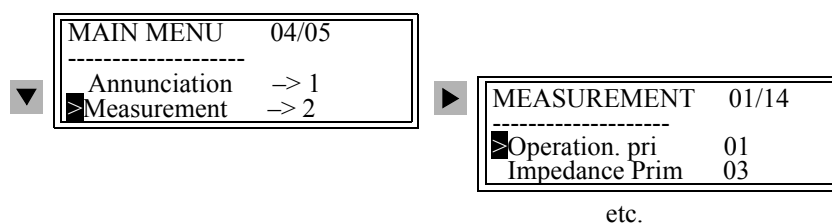

Selection of measured values — example of 4-line display

From PC with DIGSI 4

Proceed as follows:

- Double-click in the navigation window under **Measurement** on **Primary Values**.

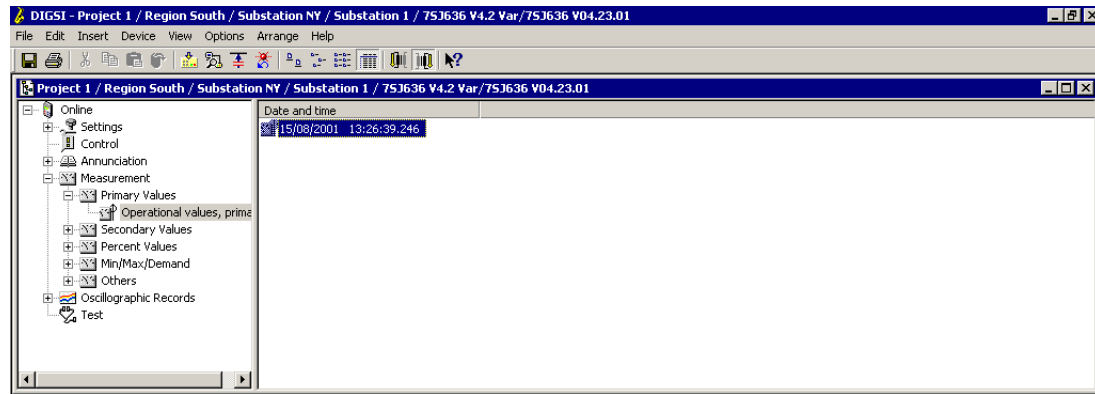

digs1612.gif

Fig. 6-23 DIGSI 4 Selection of operational measured values

- Double-click in the navigation window on **Operational values, primary**.
- Double-click on an entry in the list in the data pane.

The measured values are displayed in the **OPERATIONAL VALUES, PRIMARY** window.

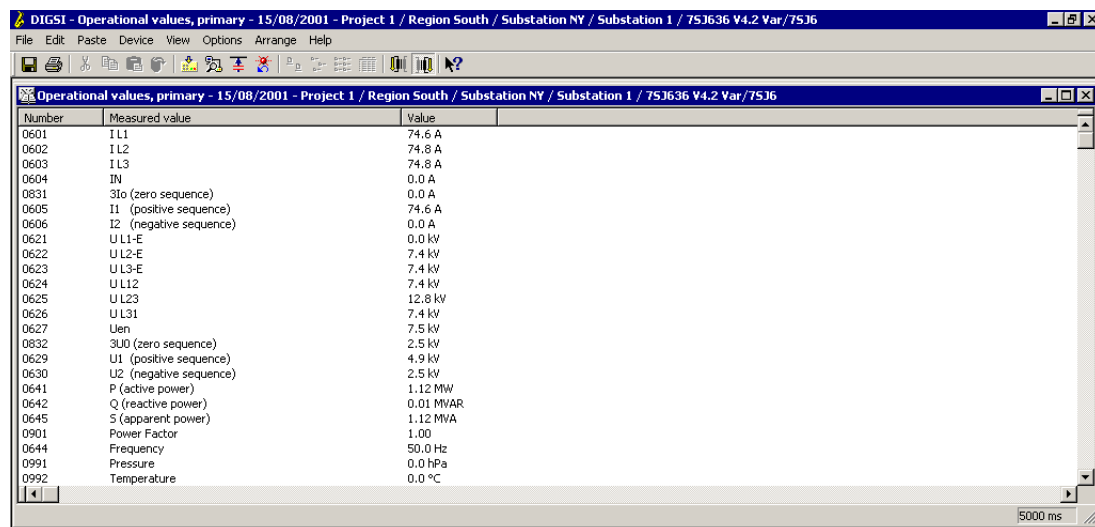

digs1613.gif

Fig. 6-24 DIGSI 4 Operational measured values, example

6.3.2 Energy Counters

Reading out Metered Values

In the maximum scope of some SIPROTEC devices, counters are available which add up the active and reactive energy (**Wp**, **Wq**) separated according to the output and input of the active energy or capacitive and inductive reactive energy, in the direction of the protected object. It is assumed that the location of the current transformer star point is configured correctly.

From the Device Front

- In the **MAIN MENU** select the **Measurement** menu item and change to the **MEASUREMENTS** submenu.
- There select the **Energy Counter** menu item and change to the **ENERGY COUNTER** menu.
- The individual values in the table of the energy counters are accessed via the paging keys.

From PC with DIGSI 4

Proceed as follows:

- Double-click in the navigation window under **Measurement** on **Other**.
- Double-click in the navigation window on **Energy Counter**.
- Double-click on an entry in the list in the data pane.

The **Energy Counter** window is displayed.

6.3.3 Setting Limit Points

SIPROTEC devices allow limit points (set points) to be set for some measured and metered values. If, during operation, a value reaches one of these set points, the device generates an alarm which is indicated as an operational message. This can be configured to LEDs and/or binary outputs, transferred via the interfaces and interconnected in DIGSI 4 CFC.

In addition you can use DIGSI 4 CFC to configure set points for further measured and metered values and allocate these via the DIGSI 4 device matrix.

From the Device Front

- In the **MAIN MENU** select the Measurement menu item and change to the **MEASUREMENTS** submenu.
- There select the **Set Points (MV)** menu item and change to the **SET POINTS (MV)** menu.
- The individual values in the table of the set points are accessed via the paging keys.
- Select the set point which you want to change and confirm the selection with **ENTER**.
- Enter the password for individual parameters and confirm it with **ENTER**.

The current value is displayed in a text box, with a blinking text insertion cursor.

- Overwrite the previous value with the new one. If the value entered does not lie within the range of values, the corresponding maximum or minimum set point is displayed at the lower screen end.
- Confirm with **ENTER**.

The new value is now displayed in the list of the set points.

- Leave the operator level by means of **MENU** or by means of the paging keys and respond at the confirmation query with **Yes** if you want to accept the changed set point, or **No** if you want to reject the inputs.

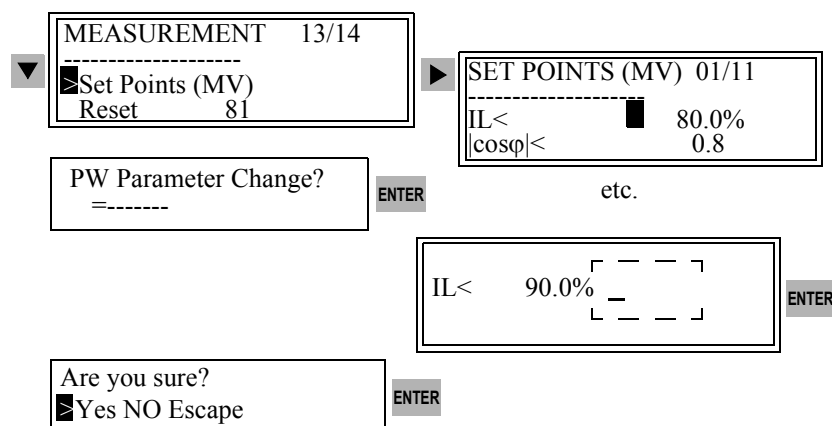

Fig. 6-25 Setting limits on the front panel — example

From PC with DIGSI 4

The set points for measured values are only accessible in **Online** mode.

Proceed as follows:

- Double-click in the navigation window under **Measurement on Other**.
- Double-click on **Set points for measured values**.
- Double-click in the data pane on an entry.

The **Set points for measured values** window is displayed.

- Select the number of the value which you want to change and click in the context menu and on **Set**.
- Enter the password for individual parameters.
- Enter the new set point in the **Set measured value** dialog box and confirm with **OK**.

The entered value is transferred to the device and the display in the **Set points for measured values** window is updated.

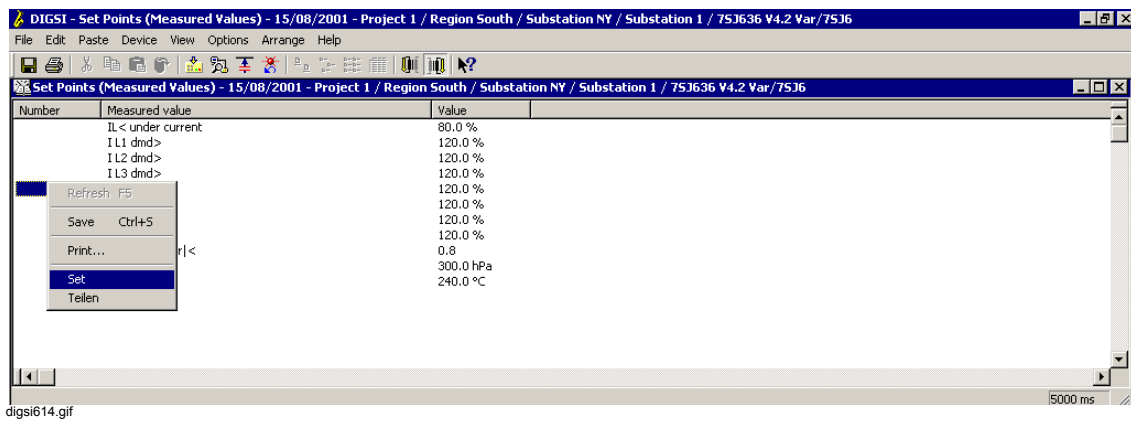

Fig. 6-26 DIGSI 4 Setting set points, example

6.3.4 Resetting Metered Values and Minimum/Maximum Values

Resetting the metered values calculated from measured values and minimum-value and maximum-value memories is always carried out for all the values of a category.

From the Device Front

- In the **MAIN MENU** select the **Measurement** menu item and change to the **MEASUREMENTS** submenu.
- There select the **Reset** menu item and change to the **RESET** menu.
- Use the paging keys to select the memory which you want to reset and confirm the selection with **ENTER**.
- Enter the password for parameter changes and confirm it with **ENTER**.
- Leave the operator level and answer the confirmation query with **Yes** if you want to reset the measured values or **No** if you want to abort the process.

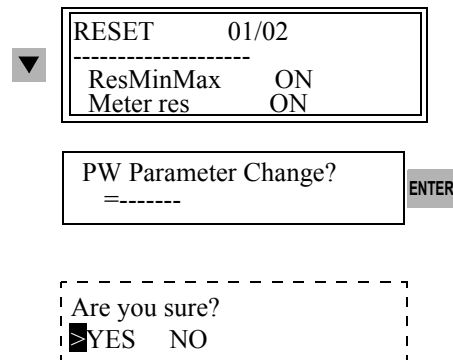

Fig. 6-27 Resetting metered values and minimum/maximum values

From PC with DIGSI 4

Proceed as follows:

- In the navigation window select under **Measurement** the **Energy counter** or **Minimum and maximum values** group and then select **Reset** in the context menu.
- Enter the password for parameter changes.

The reset process is carried out.



NOTE

The **Reset** command sets all the values without any further prompt to **Zero**. The process cannot be reversed.

6.3.5 Reading Out and Resetting User-defined Metered Values

Via DIGSI 4 CFC you have the possibility of defining pulse metered values. These can be reset to zero by means of operations.

From the Device Front

- In the **MAIN MENU** select the menu item **Measurement** and change to the submenu **MEASUREMENTS**.
- There select the **User Counter** menu item and change to the **ENERGY COUNTER** menu.

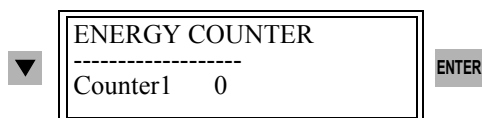

Fig. 6-28 Resetting metered values at the operator control panel, example

- Use the paging keys to select the memory which you want to reset and confirm the selection with **ENTER**.
- Enter the password for individual parameters and confirm it with **ENTER**.
- Confirm the display indication **Change OK. Continue** with **ENTER**.

Resetting has been carried out.

From PC with DIGSI 4

Proceed as follows:

- In the navigation window select the **Other** group under **Measurement**.
- Double-click on the **User-defined metered values**, select the number of the value which you want to change in the data pane and click on **Set** in the context menu.
- Enter the password for individual parameters.
- Enter the new value in the **Set values** dialog box, for example zero and confirm with **OK**.

The entered value is transferred to the device and the display in the window is updated.

6.4 Fault Recording Data

Each network fault is described by numerous instantaneous values. These instantaneous values are recorded in a fault record. Several fault records are recorded per network fault. This means that one fault indications can correspond to several fault records. The number and type of the fault records are specified in the fault record parameters (see Chapter 5).

The fault recording data are saved in the device and can be read out of the device and evaluated graphically by means of the **ComtradeViewer** or **SIGRA 4**.

6.4.1 Reading out the Fault Recording Data

From PC with DIGSI 4

Proceed as follows for the evaluation:

- Double-click in the navigation window under **Oscillographic Records** on **Oscillographic Fault Records**.

The fault records are identified by a network fault number, a fault recording number, as well as by the date and time.

Several fault recordings can exist for one network fault.

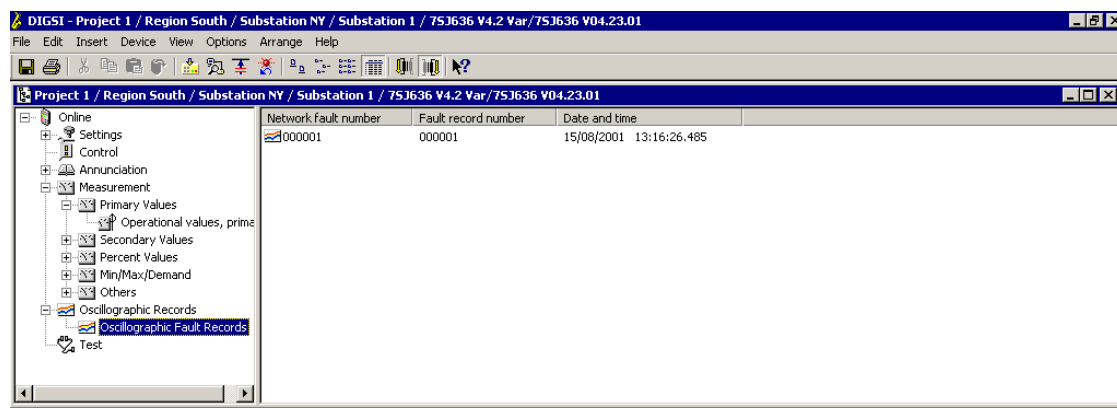

digsi615.gif

Fig. 6-29 DIGSI 4 Fault recording data, example

- Double-click in the data pane on a fault record.

SIGRA 4 graphically preprocesses the data recorded during a fault. From the measured values supplied it calculates further measurements quantities such as impedances or r.m.s. values, which facilitate the evaluation of the fault record.

The quantities can be selected freely in the diagrams of the views

- Time signals
- Vector diagrams
- Locus diagrams
- Harmonics

The selection is carried out via the **View** menu bar or the icons in the toolbar.

In addition it is possible to insert further fault records, for example from the other end of the line, and to synchronize them.

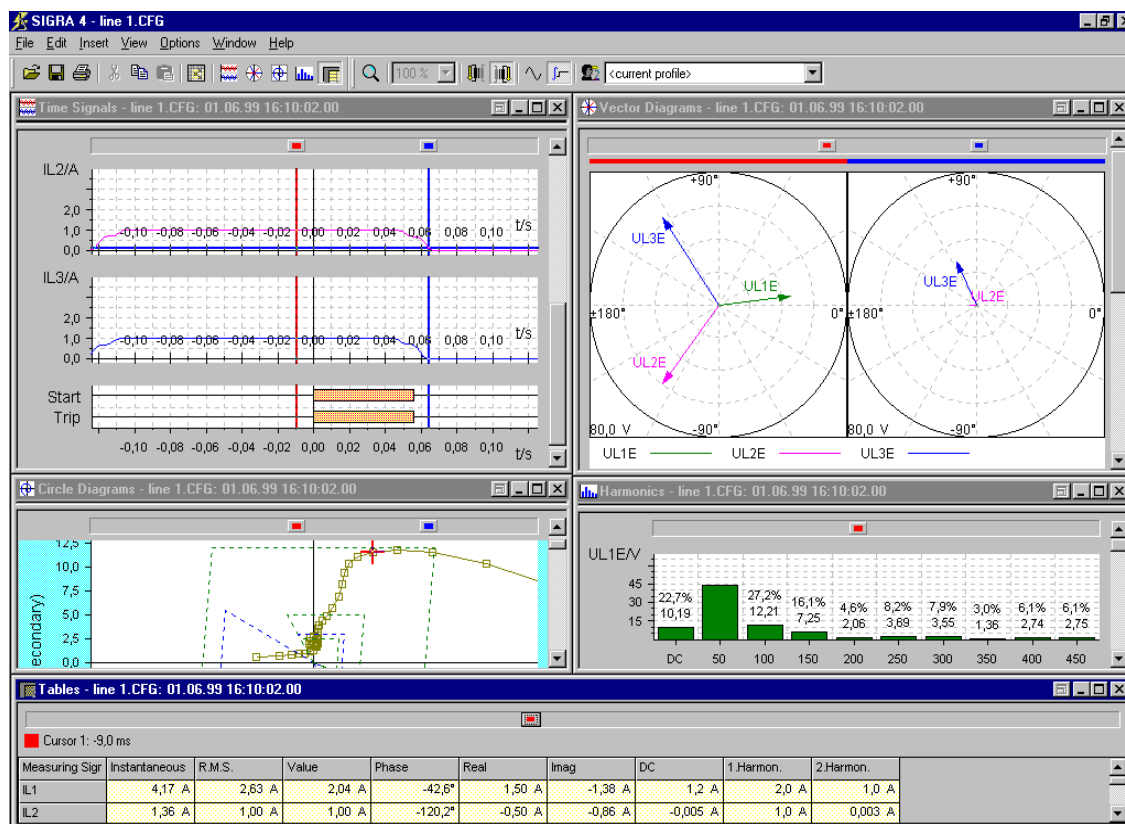

digra009.gif

Fig. 6-30 SIGRA 4, fault record evaluation, example

The current and voltage values of every phase and of the ground path are displayed separately. In addition the date and time of the read-out process are noted.

You can choose between the representation of primary and secondary quantities. The reference values for the currents and voltages are the respective secondary nominal values of the transformers. An identical scale is used for all currents referenced to the highest occurring secondary current value (instantaneous value) and for all voltages referenced to the highest occurring secondary voltage value (instantaneous value).

When time signal is selected as the view, several binary signal traces (such as general device pickup, general trip) contained in the fault record can be recorded as event marks.

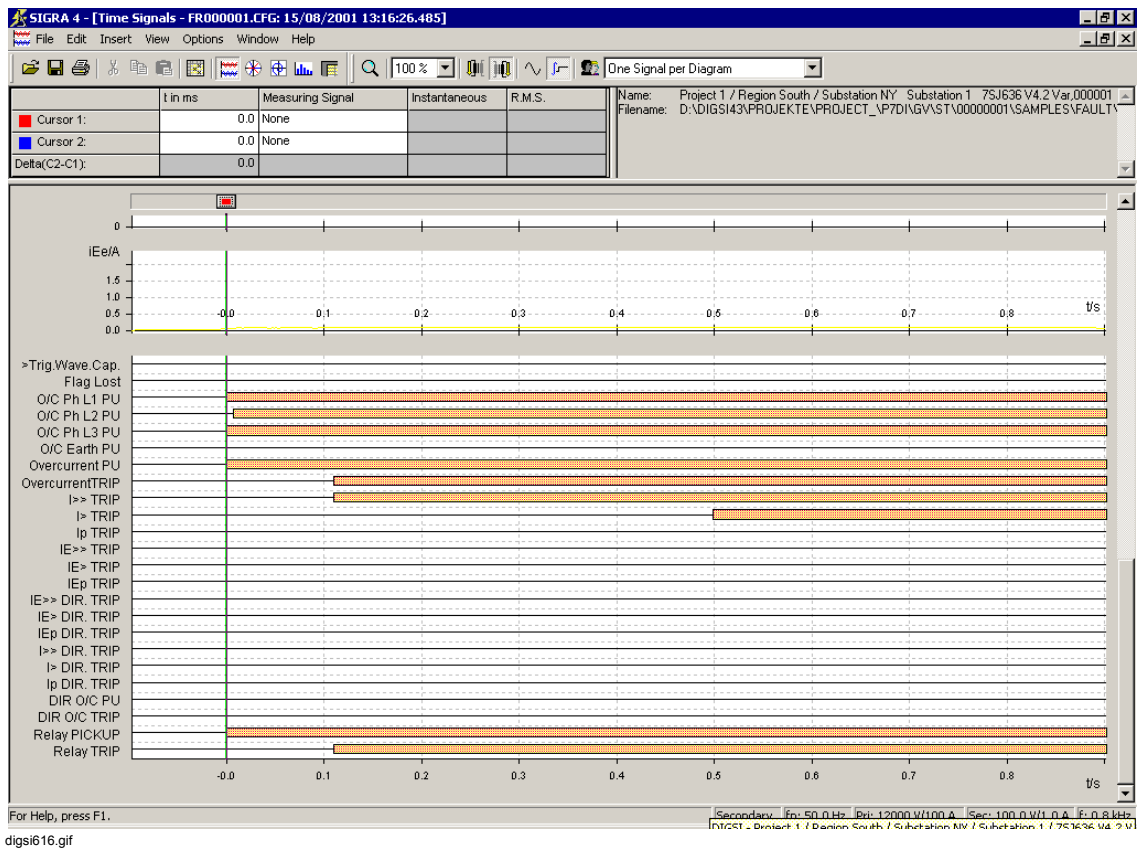

Fig. 6-31 SIGRA 4 View of time signals with binary signal traces, example

The two cursors are assigned to the time axis. In the Time Signals view the cursors are displayed as vertical lines across all the diagrams. In the case of Locus Diagrams as a crosshair. If you are interested in the exact value of a signal at a defined instant, assign a cursor to this signal. The signal name, value and instant are then displayed in the table.

There are zoom functions which can assist you in analyzing the fault.

You can print out complete fault records or selected diagrams of a view. The layout can be adapted. The definition of **user profiles** can be used to specify the assignment of the signals to the individual diagrams, labeling, line styles, etc. These are then available permanently and can be used to evaluate different fault records.

Please refer to the *SIPROTEC SIGRA 4, Manual /3/* for information on using **SIGRA 4**.

6.4.2 Saving the Fault Recording Data

Saving Fault Recording Data

The received fault recording data is not saved automatically in the PC. The fault recording data must therefore be saved explicitly.

Proceed as follows:

- Select the fault recording data and select **File > Save**.

This menu command is not active until there is fault recording data which has not yet been saved. DIGSI 4 automatically creates a directory in which the fault recording data is saved.

The fault recording data saved in the device does not have to be deleted since it is saved in a circulating buffer in which the oldest records are overwritten by the most recent ones.

6.5 Controlling Device Functions

During operation of the device, it is possible to change certain functions and indications. In addition to the reset functions of memories and the modification of event counters already mentioned these include:

- Correction of date and time
- Changing over function parameters (setting group change-over function)
- Test messages to the SCADA interface during test operation
- Changing over the operating mode



DANGER

Those carrying out operator actions must be suitably qualified and have a good knowledge of system conditions. Improper handling can cause death as well as serious injury or damage to property.

6.5.1 Reading and Setting the Date/Time

At a device startup a plausible time is usually displayed. This time can be updated automatically in case of an external synchronization, for example DCF77 or GPS, or adjusted manually.

Different times can be displayed on the device until synchronization has been carried out and a valid time exists:

Time Status

In addition to the date and time themselves their status is also displayed. With regular states in the clock setup the status display can have the following form:

Table 6-1 Time status

No.	Status text	Status
1	--- ---	Synchronized
2	--- --- ST	
3	--- ER --	Not synchronized
4	--- ER ST	
5	-- UG ER --	
6	-- UG ---	

The identifiers in the status text have the following meaning:

UG	Time invalid	After startup the time was neither set manually nor synchronized In case of synchronization via the system interface the transmitted time value is identified as "invalid", cyclic synchronization continues to be carried out
ER	Time fault	At present there is no cyclic synchronization in the context of the tolerance time (time can jump).
ST	Summer time	The last synchronization time which was received supplied a summer time bit (Central European Summer Time)



NOTE

An error-free state is identified by the texts Number 1 or 2 in accordance with Table 6-1.

Display of the Time

Different times can be displayed in the device display and in the time stamp of the indications and measured values.

No	Displayed		Year	Time fault	Time invalid
	Date	Time			
1	**.*.*.****	15?07:15	Year = 1990	Irrelevant	
2	04.09.1998	15?07:15	1990<Year<2090	Yes	No
3	04?09.1998	15?07:15		Yes	Yes
4	04.09.1998	15:07:15		No	No
5	**?*.*.****	15?07:15		No	Yes

No. 1 occurs when the RTC did not supply a valid time during the startup. In the message buffers the messages have the date 01.01.1990.

- Set the date and time manually.

No. 2 occurs when the time has been set but not synchronized. This can happen:

- Briefly when the device starts up,
- When the cyclic synchronization is interrupted for longer than the set tolerance time.
- Check the function and correct connection of the external synchronization unit.

No. 3 is displayed when the internal clock block supplied a valid value during the device startup and the time was neither set manually nor synchronized.

- Set the time and date manually or wait until the cyclic synchronization takes effect.

No. 4 shows the normal state, the time is synchronized cyclically in accordance with its operating mode.

No. 5 is displayed when the transmitted time value is identified as "invalid" during synchronization via the system interface.

Changing the time

The time can be changed

- By manual time setting via the integrated operation or via DIGSI 4,
- By changing the parameters for the clock setup.

Setting is possible at any time both in the "Internal" mode as well as at "Pulse BE". The resulting time jump is displayed with the operational indications **Fault Clock ON** and **Fault Clock OFF**. In case of **Pulse BE** the indication **Fault Clock OFF** is displayed as soon as a pulse edge has arrived after a time adjustment.

In order to avoid time jumps, manual adjustment is only accepted in the other modes if the synchronization is marked as faulty. IRIG-B adjustment of the year is possible at any time, accompanied by the indications **Fault Clock ON** and **Fault Clock OFF**.

The date and time can be adjusted relatively (+/- 23:59:59) via the "Diff.-time" input field. This input possibility should not be confused with the parameter **Offset** (see Chapter 5) that acts on the synchronization time of the radio clock receiver.

Setting the Date/Time

Please note that the internal clock only runs for a maximum of one day if the supply voltage fails. If the supply voltage fails for a longer period, the date and time have to be reset.

From the Device Front

- In the **MAIN MENU** select the **Settings** menu item and change to the **SETUP/EXTRAS** submenu.
- There select the **Date/Time** menu item and change to the **DATE/TIME** menu.

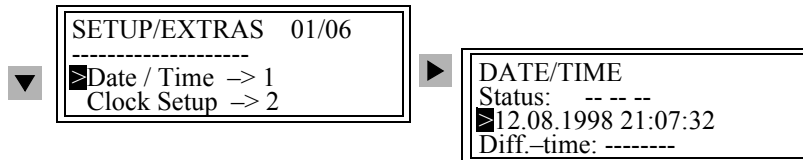

Fig. 6-32 Operating menu for manual setting of the date and time

- Use the paging keys to select the date/time or differential time and confirm with **ENTER**.
- Enter the password for **parameter changes**.
- Overwrite the previous setting in the text box with a blinking text insertion cursor. Be sure to write the entry correctly.
- Confirm with **ENTER**.

In order to change the **Time offset** or **Tolerance time** when there is a fault in the time signal:

- **Setup/Extras** submenu.
- In the **SETUP/EXTRAS** submenu select the **Clock Setup** menu item and change to the **CLOCK SETUP** menu.
- Overwrite the time offset under **Offset** or overwrite the time delay for the indication after failure of the time synchronization and the source of the time synchronization under **Error Time**.
- Confirm with **ENTER**.

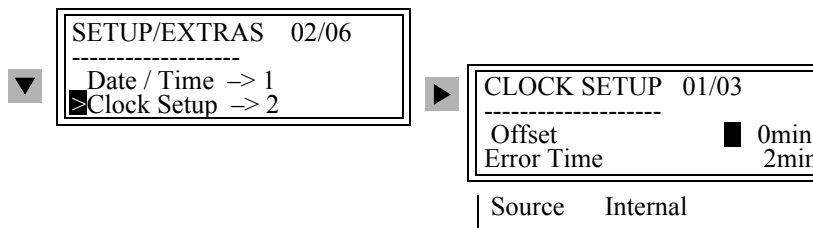

Fig. 6-33 Operating menu for the date and time setup

From PC with DIGSI 4

Proceed as follows in order to enter the date and time manually:

- Open the device in the **Online** mode.
- Click **Device > Set Date and Time**.

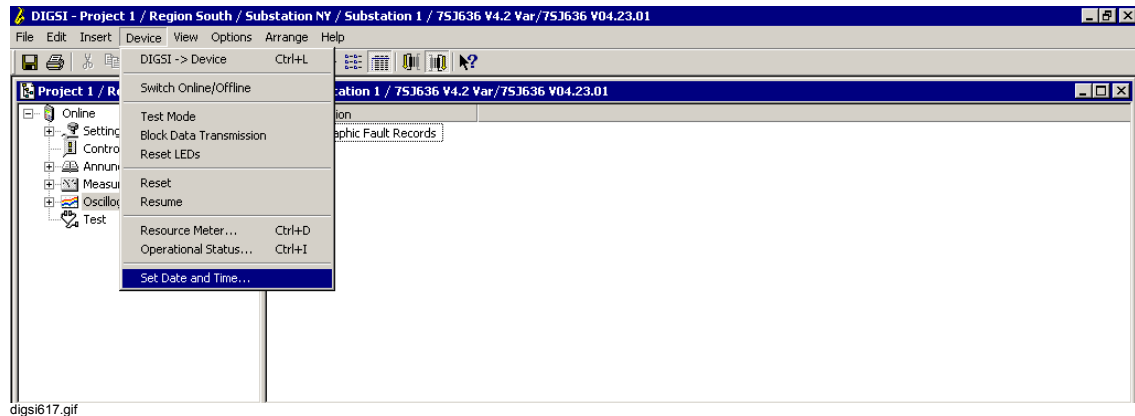
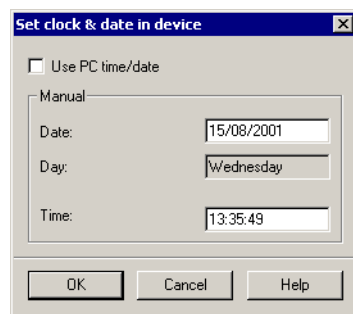

Fig. 6-34 DIGSI 4 Setting the time, example



digs1618.gif

Fig. 6-35 DIGSI 4 Setting the date & time in the device

The values displayed in the **Set clock & date in device** dialog box correspond to the current date and the current time. The day of the week is automatically calculated from the date and cannot be changed.

- Enter the new values for the **date** and **time**. Be sure to write the entry correctly.
- Confirm by clicking **OK**.

The set values are transferred to the device.

Time Offset / Tolerance Time

Proceed as follows to change the **time offset** or **tolerance time** if the clock signal is faulty:

- Double-click **Settings** and double-click in the function selection on **Time Synchronization**.

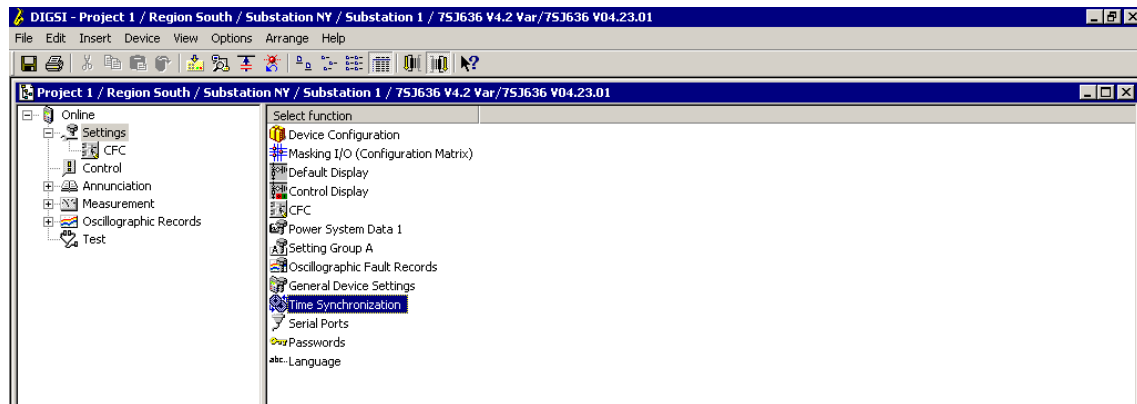

Fig. 6-36 DIGSI 4 Selection of time synchronization

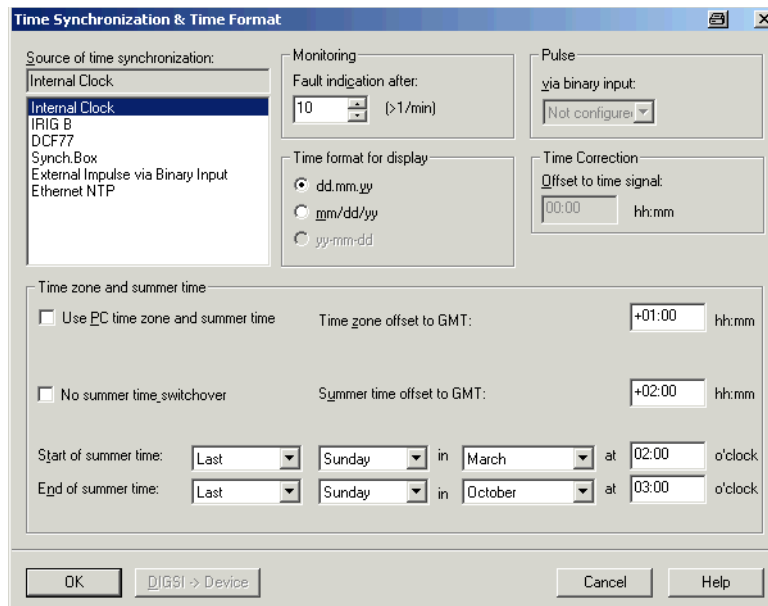

Fig. 6-37 DIGSI 4 Time synchronization and time format

- Change the "Fault indication after" in the **Monitoring** section and the time offset in the **Offset to time signal** input box.

6.5.2 Settings Group Change Option of the Functional Settings

Up to four different setting groups A to D can be set for the protective-function-specific groups. You can change these over during operation. The changeover possibility is set during the configuration.

From the Device Front

- In the **MAIN MENU** select the **Settings** menu item and change to the **SETTINGS** submenu.
- There select the **Change Group** menu item and change to the **CHANGE GROUP** menu. The currently active settings group is displayed.
- Select **CHANGE to** and confirm with **ENTER**.
- Enter the password for **individual parameters** and use the paging keys to select the new group.
- If you select **Via Binary Input**, the group changeover is controlled via binary inputs provided corresponding configurations and wiring exist.
- If you select **Via Protocol**, the group changeover can be controlled via the system interface (IEC 60870-5-103).

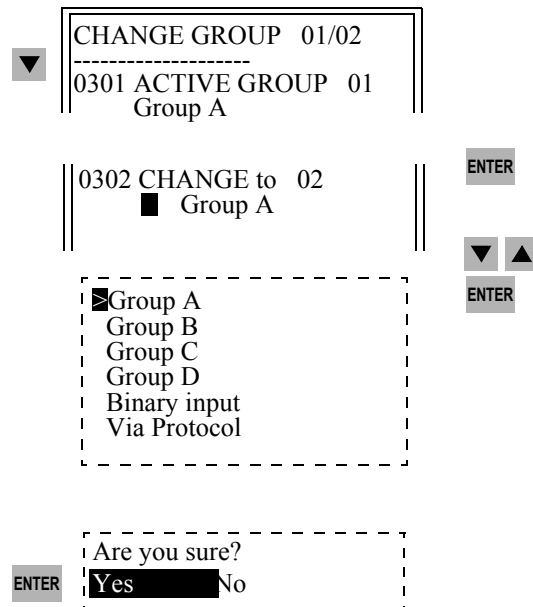
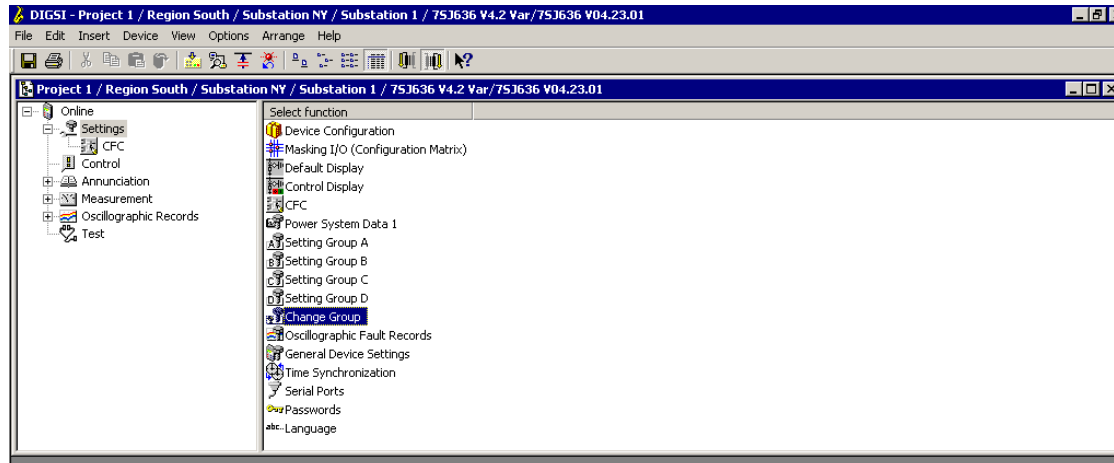

Fig. 6-38 Changeover of settings groups

From PC with DIGSI 4

- Open the device in the **Online** mode.
- Double-click **Settings** and double-click in the function selection on **Change Group**.



digsig621.gif

Fig. 6-39 DIGSI 4 Selecting the settings group change option

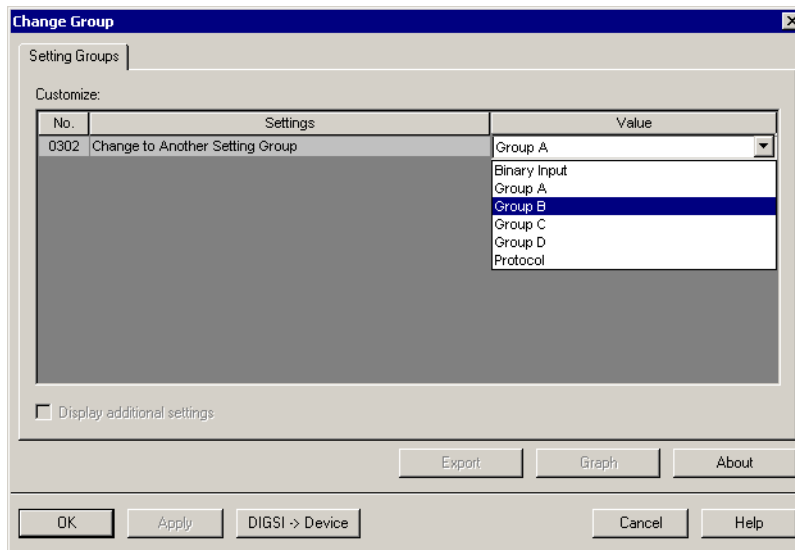

digsig622.gif

Fig. 6-40 DIGSI 4 Settings group change option

The settings group currently active is displayed.

- In the **Value** box use the drop-down list box to select the **Group** or **Binary Input** or **Protocol** and click on the **DIGSI > Device** command button.
- Enter the password for individual parameters and confirm it with **OK**.

6.5.3 Changing Information on the System Interface during Testing Operation

If the device is connected to a centralized control or storage system, you can change the information which is transmitted to the control center.

Some of the protocols offered allow the transfer of all the indications and measured values to the control center when the device is being tested locally. In order to identify this special operating state the indication cause **Test mode** is assigned to the information.

If you set the **transmission block**, no indications are transmitted via the system interface during the test. (For a PROFIBUS FMS connection, indications will be transmitted with the status bit set.)

Blocking data transmission can be accomplished by controlling binary inputs, by using the operating panel on the device, or with a PC and DIGSI via the operator interface.

From the Device Front

- In the **MAIN MENU** select the **Test / Diagnose** menu item and change to the **TEST/DIAGNOSTICS** submenu.
- There select the **Test Enable** menu item and change to the **TEST ENABLE** menu.

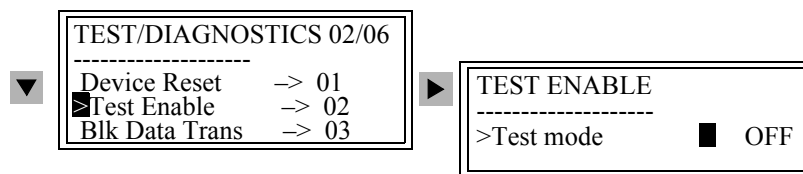

Fig. 6-41 Operating menu for test mode on the front panel

- Select **Test mode** and confirm with **ENTER**.
- Enter the password for **testing and diagnostics** and confirm it with **ENTER**.
- In the subsequent window select **ON** or **OFF** and confirm the confirmation query.

If the mode was changed, the indication **Change OK** is displayed briefly in the footer.

The state **OFF** is preset for test operation.

In the **ON** setting **Test mode** is transferred as the indication cause for IEC 60870-5-103 compatible indications.

- Set the transmission block similarly to the described procedure.

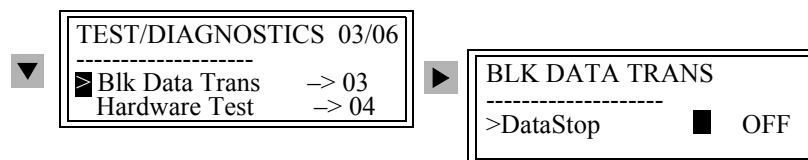
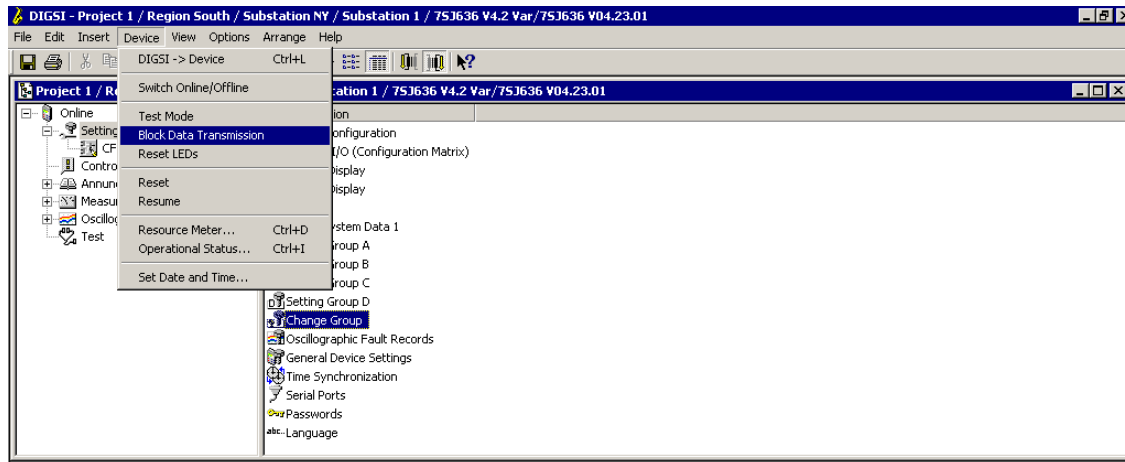

Fig. 6-42 Operating menu for setting the transmission block (simplified)

The **ON** state means that no messages and measured values are transferred.

From PC with DIGSI 4

- Carry out selection via **Device > Test Mode** or **Block Data Transmission**.



digs623.gif

Fig. 6-43 DIGSI 4 Setting transmission blocking

Activation of the test mode or of the transmission blocking is identified by a check mark before the command.

- Click on **Test Mode** or **Block Data Transmission** in order to activate or de-activate the function, depending the current state.
- Enter the password for **testing and diagnostics** and confirm it with **OK**.

**NOTE**

After you have completed the tests set all the activated blockings back to OFF!

6.5.4 Changing Over the Operating Mode

In case of tests and plant revision it is possible to change the operating mode of a device in order to carry out such work with a minimum effect on the operation. This applies in particular for differential protection devices.

The function is not implemented in all the devices. Therefore please refer to the device manual for further details.

6.5.5 Allocating an Operator Level to Function Keys

DIGSI 4 offers the option to allocate operator levels of the device operating tree of SIPROTEC 4 devices to function keys. When you press the function key on the device, it jumps to the configured operator level directly.

To allocate an operator level to a function key, proceed as follows:

- Select **Options > Set function keys** from the menu of the configuration matrix. You reach the **Set function keys** dialog box.

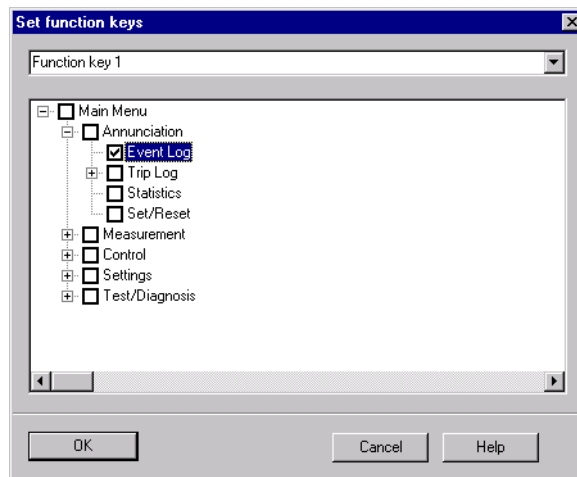

digsi633.gif

Fig. 6-44 Set function keys

- Select the function key which you would like to set from the drop-down list box. If this function key has already been allocated to an operator level, it will be indicated via a check in the relevant select box of the operating tree.
- Click the desired operator level in the displayed operating tree. Note that the operator levels *Default Display*, *Control Display* and *Start-up Display* are not offered.



NOTE

If the function key has already been allocated to single indications (see Chapter 5.5.4), you will receive an indication to that effect.

- Click **OK** to save the allocation. Any allocation already present in the device matrix will be deleted.

6.6 Circuit Breaker Test Function

The possibility of testing circuit breakers is provided in particular for protection devices without integrated control. In case of protection devices which can output single-pole tripping commands, the circuit breaker test is also designed for individual testing of the switching poles.

You can carry out a test of the trip circuits and circuit breakers during operation by carrying out a TRIP and CLOSE circuit operation via the device.

Prerequisite is that the corresponding test commands are configured to the command relays during the configuration. It is possible to check the circuit breaker poles individually provided that the device is capable of single-pole tripping, the circuit breaker is capable of single-pole tripping and the wiring and configuration has been implemented correspondingly.

A maximum of four test programs are available.

One- and three-pole TRIP/CLOSE test cycles can be triggered for the circuit breaker. In the case of three-pole tripping only the test program No. 4 applies.

Table 6-2 Circuit breaker test programs

Serial No.	Test programs	Operational indications
1	1-pole TRIP/CLOSE-cycle phase L1	CB1-TEST TRIP command - Only L1
2	1-pole TRIP/CLOSE-cycle phase L2	CB1-TEST TRIP command - Only L2
3	1-pole TRIP/CLOSE-cycle phase L3	CB1-TEST TRIP command - Only L3
4	3-pole TRIP/CLOSE-cycle	CB1-TEST TRIP command L123
	Associated close command	CB1-TEST CLOSE command

If the circuit breaker auxiliary contacts pass the position of the switch via binary inputs to the device, the test cycle can only be initiated when the circuit breaker is in closed position.

A further prerequisite for test initiation is that no protection function in the device has picked up and that the circuit breaker is ready.

The device indicates the respective status of the test sequence by corresponding indications in the display or on the PC screen. If the device refuses to run the test or aborts it, one of the test preconditions for the execution of the test cycle is not fulfilled. The reason for the refusal or for aborting is indicated in the device display or on the PC screen.

CB-TEST running	Circuit breaker test running
CB-TSTstop FLT.	Circuit breaker test cannot be started since there is a system fault
CB-TSTstop OPEN	Circuit breaker test cannot be started since the circuit breaker is not closed
CB-TSTstop NOT	Circuit breaker test cannot be started since the circuit breaker is not ready
CB-TSTstop CLOS	Circuit breaker test has been terminated because the circuit breaker is still closed (prior to circuit breaker test reclosure)
CB-TST .OK.	Circuit breaker test has been completed successfully

The following diagram shows the test sequence in principle:

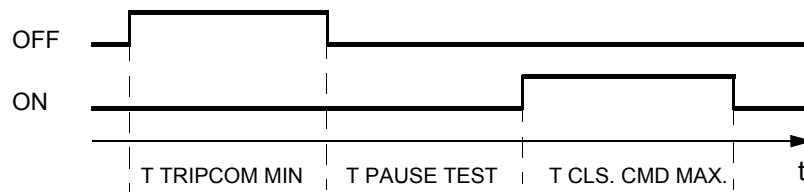

Fig. 6-45 TRIP-CLOSE test cycle



DANGER

The successful initiation of a test cycle can cause the circuit breaker to close!

From the Device Front

- In the **MAIN MENU** select the **Test / Diagnosis** menu item and change to the **TEST / DIAGNOSIS** submenu.
- There select the **CB Test** menu item, change to the **CB TEST** menu in order to select the test program and confirm with **ENTER**.
- Enter the password for **test and diagnostics**, confirm with **ENTER** and respond to the confirmation query **Breaker closed?** with **Yes** and **ENTER** if the circuit breaker is closed.

When circuit breaker auxiliary contacts are connected and configured, the device refuses the test cycle if the auxiliary contacts signal a circuit breaker which is not closed, even if the operator confirms the opposite. Only if the auxiliary contacts are not configured does the device respond to the confirmation by the operator.

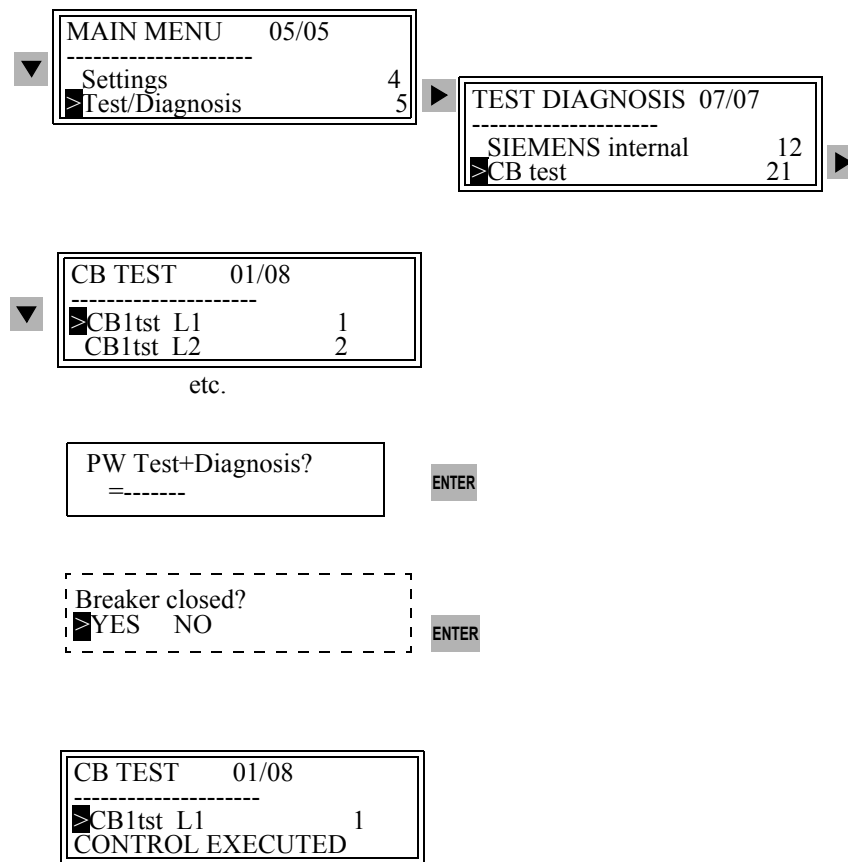
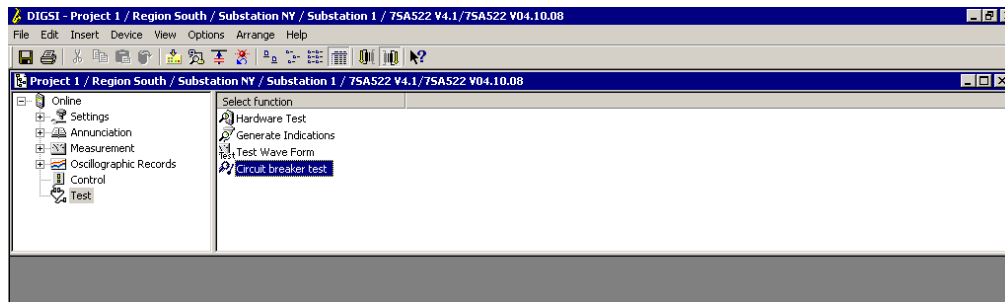

Fig. 6-46 Circuit breaker trip test cycle at the operator control panel of the device

From PC with DIGSI 4

- Open the device in the **Online** mode.
- Double-click **Settings** and double-click in the function selection on **Circuit Breaker Test**.



digsi627.gif

Fig. 6-47 DIGSI 4 Selection of circuit breaker test

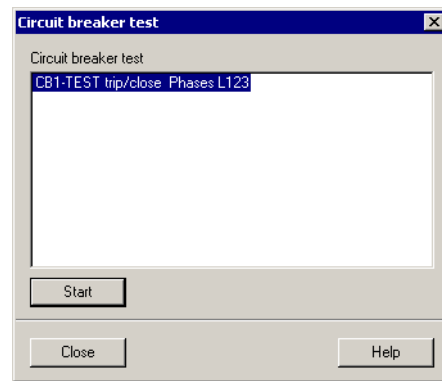

digsi628.gif

Fig. 6-48 DIGSI 4 Circuit breaker test, example

- Double-click in the **Circuit breaker test** dialog box on the test program, enter the password for **test and diagnostics** and confirm with **OK**.

The course of the test with command feedbacks and indications is displayed in the **Spontaneous Annunciation** window.

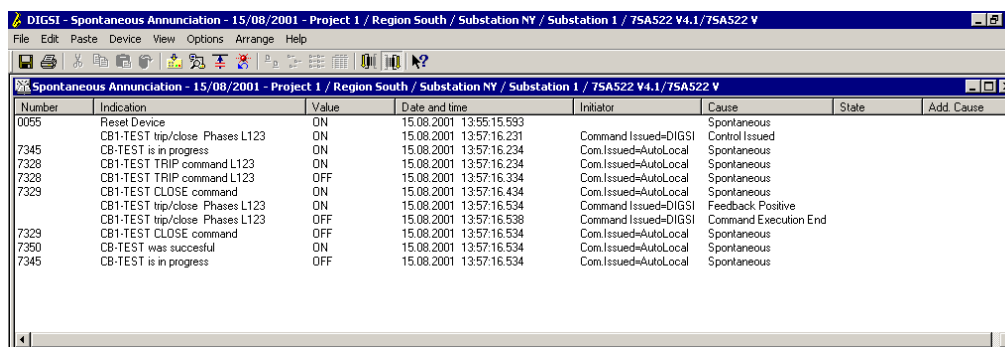

digsi629.gif

Fig. 6-49 DIGSI 4 Circuit breaker test spontaneous annunciation, example

6.7 Control of Switchgear

SIPROTEC devices contain control functions for processing

- Unsynchronized switching commands for the operation of circuit breakers, disconnectors and ground electrodes
- Step commands for increasing and decreasing transformer LTC steps and
- Setpoint commands with configurable time settings for controlling Petersen coils.

Safety mechanisms in the command sequence ensure that a command can only be released after a thorough check of preset criteria has been successfully concluded (interlocking checks).

Switchgear of your plant can be switched on and off by means of the operator control panel of the device and via DIGSI 4.

During the configuration process configure the binary inputs and outputs of your device correspondingly and use DIGSI 4 CFC to define the interlock conditions of your plant.

If an auxiliary contact pair (on and off) is available on a switching device and if you have taken this into consideration while configuring the device, you can monitor these switch position feedbacks for plausibility.

If there is no ON or OFF position indication from a switch, the device is displayed as faulty and all the switching operations are blocked in the interlocked switching mode.

Switching operations are carried out via:

- Local operation using the integrated operator control panel,
- Operation via the operator interface with DIGSI 4,
- Binary inputs,
- Remote control using the system interface.

The switching priority is configured by means of the **switching authority**.

In the case of **interlocked switching** the observance of all the configured interlocking conditions is checked before a switching operation is carried out. If a condition is not fulfilled, the command is refused and a corresponding operating fault message is issued.

Predefined interlocks are implemented device-specifically in the device. These can be adapted project-specifically during the configuration.

The following tests can be activated or de-activated for a switching device:

- Switching authority,
- Bay interlocking (for example via CFC),
- Station interlocking (for communication with a control center),
- Double operation locking (interlocking against parallel switching operations),
- Protection Blocking (blocking of switching operations by protective functions),
- Device position monitoring (Setpoint = Actual comparison).

6.7.1 Control by Means of a Higher-level Control System

If your SIPROTEC device is integrated in a control system for example the SICAM SAS station control system, it can be controlled from there by means of the SICAM WinCC operator control and monitoring system.

The device has an interface which is used for the connection to higher-level control centers. Via that interface the device can receive standardized command messages and pass them to the affected switching devices, set flags, or trigger logic tests configured via CFC such as interlock conditions or switching sequences.

Depending on the device you can communicate via PROFIBUS, directly or via modem.

6.7.2 Displaying the Switch Position and Switching

From the Device Front

Devices with graphical display enable the user to read out the current switching device positions in the default and control display. You can control the process by means on the control display, the ON/OFF switch and keyswitches at the operator control panel.

Proceed as follows:

- Press **CTRL** and use the paging keys to navigate in the control display to the switching device which you want to switch.
- Press the **ON** or **OFF** switch in order to select the switching direction.

The switch symbol in the control display flashes in the target setting.

- Confirm the switching operation with **ENTER**.
- Confirm the confirmation query with **ENTER** or abort with **ESC**. If you do not confirm within a minute, the setpoint flashing returns to the actual state.

If the switching command can be executed, the switching device is displayed in the new actual state and the indication **End of command** at the lower display edge. The indication **FB reached** is displayed briefly before the final indication in the case of switching commands with a feedback.

If the switching command is refused because an interlocking condition is not met, then an operation response appears in the display indicating the reason for the rejection.

- Confirm this operating response with **ENTER**.

You can read out the switch positions via display menus and initiate switching operations for of all devices (with 4-line or graphical display).

- In the **MAIN MENU** select the **Control** menu item and change to the **CONTROL** submenu.
- There select the **Breaker/Switch** menu item and change to the **BREAKER SWITCH** menu.

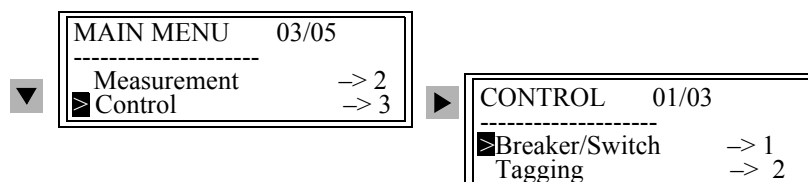

Fig. 6-50 Operating menu for selecting the control of switchgear in the display

- There select the **Display** menu item and change to the **DISPLAY** menu. The switch positions of the planned switching devices are displayed.

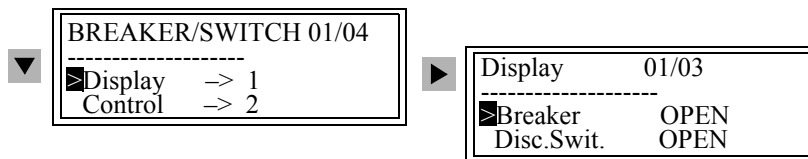

Fig. 6-51 Operating menu for displaying switch positions in the display — example

Proceed as follows if you want to control a switching device:

- Select the **Control** menu item and change to the **CONTROL** menu. The actual state of the switch positions of the planned switching device is displayed.
- Use the paging keys to select the switching device and confirm with **ENTER**.
- Enter the password for **interlocked switching** and confirm it with **ENTER**.

The enable for further state changes remains active until you close the **BREAKER/SWITCH** menu.

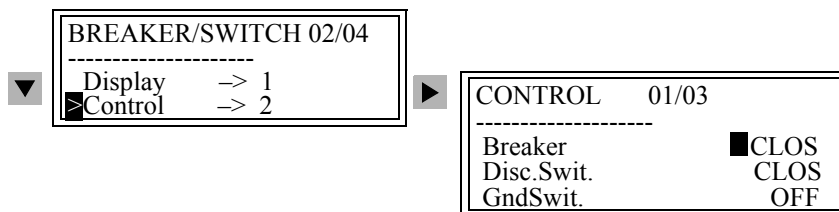

Fig. 6-52 Controlling the switching devices in the display, example



NOTE

If the switching mode is **NON-INTERLOCKED**, all switching operations are possible. A password is required for **non-interlocked switching**.

- Various options are offered depending on the operating and command type of the selected switching object. Select the switching direction and confirm with **ENTER**.
- Confirm the confirmation query with **Yes** and **ENTER**.



Fig. 6-53 Selection window for the switch operation in the display — example

If the switching command is refused because the user has no switching authority or an interlocking condition is not met, then an operation response appears in the display. The response indicates why the control command was not accepted.

- Confirm this operating response with **ENTER**.

From PC with DIGSI 4

- Open the device in the **Online** mode.
- Double-click **Control** and double-click in the function selection on **Breaker/Switches**.

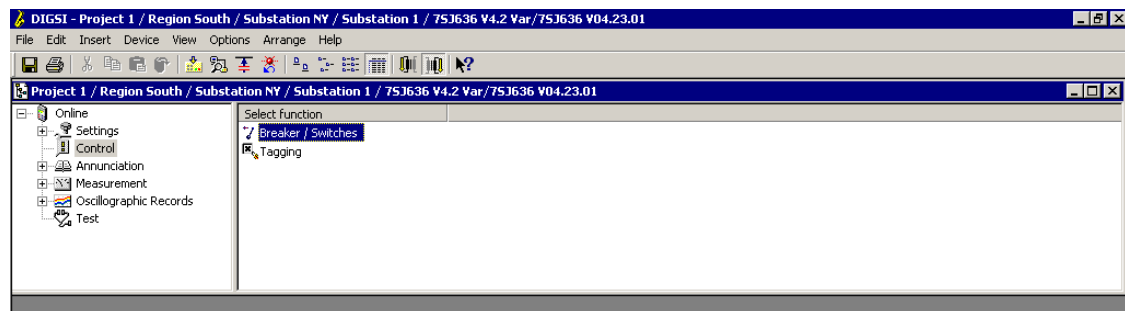

digsi625.gif

Fig. 6-54 DIGSI 4 Controlling, selecting the devices



NOTE

You require the **REMOTE** switching authority in order to carry out switching operations via DIGSI 4. The switching authority is transferred to DIGSI 4 when you call up the **Control** function.

If the switching mode is **NON-INTERLOCKED**, all switching operations are possible. You require the password for **non-interlocked switching** to this purpose.



DANGER

Non-interlocked switching requires a high qualification and exact knowledge of the plant conditions. Illegal switching operations can cause death or serious injuries and damage to property.

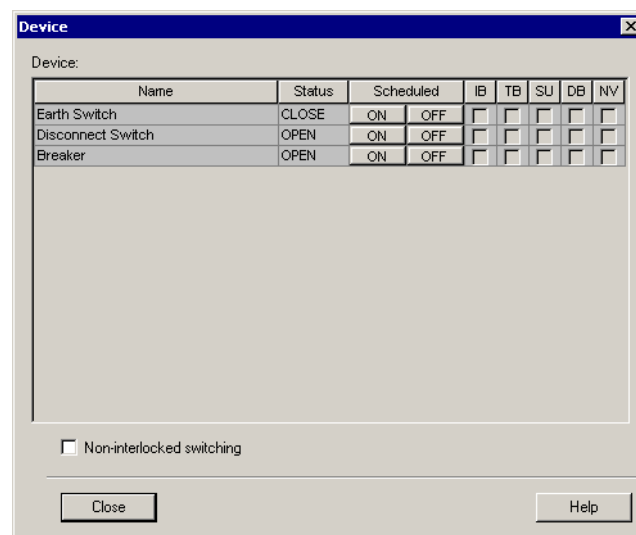

digsi626.gif

Fig. 6-55 DIGSI 4 Controlling

The **Device** dialog box shows the actual state of the switching device.

If the columns input block (IB), transmission block (TB), substitution (SU), and chatter blocking (CB) are selected, the respective function is active or the switching state of the switching device was substituted.

- Click on the **Scheduled** column on the **OFF** or **OFF** command button in order to specify the setpoint position and respond to the confirmation query.
- Enter the password for **interlocked switching** and confirm it with **OK**.

The enable for further changes in state remains in force until the **Device** dialog box is closed or the switching mode is changed.

If the switching command was transmitted successfully the display of the actual state is updated in the **Device** dialog box.

6.7.3 Manual Overwriting

If a switch position feedback fails, switch operation is blocked. If the respective switch has to be operated nevertheless, it is possible to specify the current switch position by manual overwriting. The overwritten switch position continues to be used in the device and, for example is taken into consideration in the interlock conditions.

Manual overwriting is only possible if the **input block** is set for the switching device (see Chapter 6.7.4).

From the Device Front

Proceed as follows:

- In the **MAIN MENU** select the **Control** menu item and change to the **CONTROL** submenu.
- There select the **Breaker/Switch** menu item and change to the **BREAKER SWITCH** menu.
- Select the **Man. Overwrite** menu item and change to the **MAN. OVERWRITE** menu.

The actual state of each switching device is displayed.

- Page to the switch whose switching state is to be overwritten manually and confirm with **ENTER**.
- Enter the password for **non-interlocked switching** and confirm it with **ENTER**.

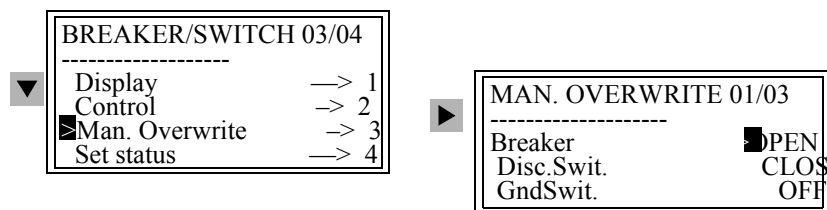

Fig. 6-56 Manual overwriting of the switching devices in the display

- Select the switching state CLOSE or OPEN and confirm with **ENTER**.



Fig. 6-57 Selection window for manually substituting a switch position in the display

- Respond to the confirmation query with **Yes** and **ENTER**.

A corresponding indication is displayed if manual overwriting is not allowed, for example because the input block is not set.

- Acknowledge the indication with **ENTER**.

From PC with DIGSI 4

For safety reasons manual overwriting is only allowed directly locally by using the operator control panel of the device, but not via DIGSI 4.

6.7.4 Set Status

During commissioning or testing it can be useful to briefly remove the coupling between the switching device and the device or between the device and the central device without having to disconnect the connection physically. Such a separation can be necessary for example when a switch position feedback does not function correctly. This function can be carried out by means of **Set status**. The status of a switching device is identified by a character.

- T** Device is tagged (manually overwritten)
- I** Input blocked set, signal input decoupled
- B** Blocked, transmission to the central device blocked
- C** Chatter block active due to frequent indication changes
- O** Output block active, i.e. the command output is decoupled
- None of the specified limitations applies.



NOTE

The input block only acts on the inputs of the device.
Do not set an input block for manually overwritten indications which were created by CFC configuration. In these indications the input block does not lead to the plant being decoupled.

From the Device Front

- In the **MAIN MENU** select the **Control** menu item and change to the **CONTROL** submenu.
- There select the **Breaker/Switch** menu item and change to the **BREAKER SWITCH** menu.
- There select the **Set status** menu item and change to the **SET STATUS** menu.
- Scroll in the **I** (input block) or in the **O** (output block) column of the switch whose status you wish to change and confirm it with **ENTER**.
- Enter the password for **non-interlocked switching** and confirm it with **ENTER**.

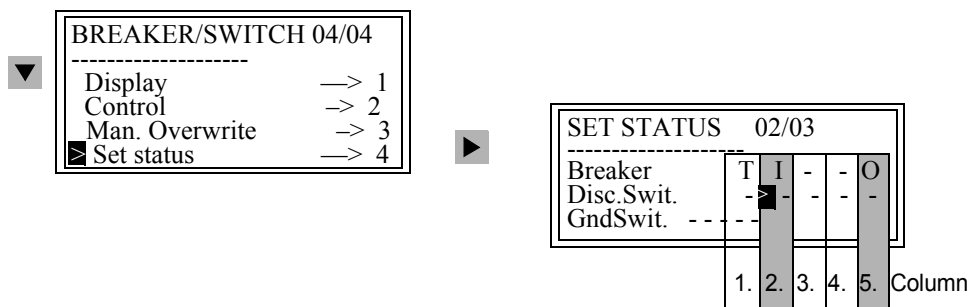

Fig. 6-58 Operating menu for setting the status in the display

- Select the status and confirm with **ENTER**.
- Respond to the confirmation query with **Yes** and **ENTER**.

**NOTE**

The 2nd column is reserved for setting the input block **I**, the 5th column for setting the output block **A**. Columns 1, 3 and 4 can only be read out.

The example above shows that the switch position of the circuit breaker Q0 has been manually corrected **T** after the input block **I** has been set, meaning that the message input has been decoupled from the plant. In addition the output block **O** is active meaning that the command output has been decoupled from the plant. No limitations are set for the disconnecter Q1 and ground switch Q8.

From PC with DIGSI 4

For safety reasons a **status change** is **only** allowed directly locally by using the **operator control panel** of the device, but not via DIGSI 4.

6.7.5 Interlockings

The devices such as circuit breakers, disconnectors, ground electrodes, etc. are subject to specific interlock conditions. These can be read out at the device but not modified.

The configured interlock reasons are indicated by a character for each switching device.

- **L** Check for switching authority;
- **S** Object subject to plant interlocks (commands entered locally are sent to the control center);
- **Z** Check zone interlocking,
- **P** Check switch position (check actual = setpoint);
- **B** Blocking by picked-up protection elements;
- **-** Non-interlocked.

From the Device Front

Proceed as follows:

- In the **MAIN MENU** select the **Control** menu item and change to the **CONTROL** submenu.
- There select the **Interlock** menu item and change to the **INTERLOCK** menu.

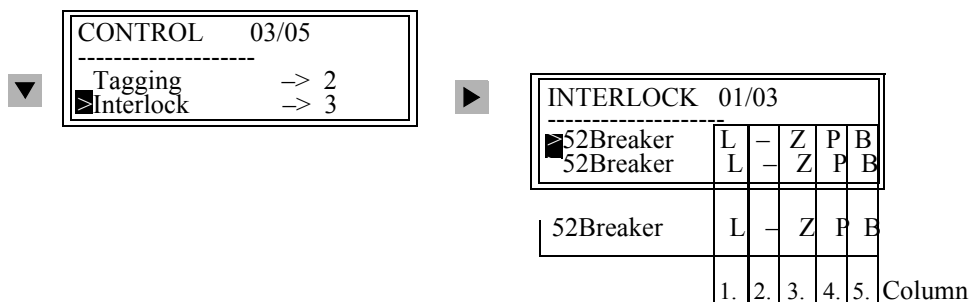

Fig. 6-59 Reading out the interlocks of devices in the display, example

From PC with DIGSI 4

Proceed as follows:

- Open the device in the **Online** mode.
- Double-click **Settings** and double-click in the function selection on **Masking I/O**.
- Select the switching device and open the **Object properties** dialog box via the **Object properties** context menu.

Active test conditions for interlocked switching are identified by a check mark.

Password input is not required.

6.7.6 Tagging

In order to identify unusual operational statuses in your plant you can set taggings, for example grounded. These taggings can, for example, be included as additional operating conditions in interlock checks. Taggings are configured like devices.

From the Device Front

- In the **MAIN MENU** select the **Control** menu item and change to the **CONTROL** submenu.
- There select the **Tagging** menu item and change to the **TAGGING** menu.
- Select **Display** or **Set**.

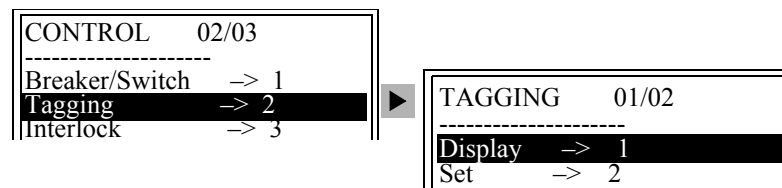

Fig. 6-60 Displaying settings in the display

From PC with DIGSI 4

For safety reasons **tagging** is **only** allowed directly locally by using the **operator control panel** of the device, but not via DIGSI 4. Switching Authority

The switching authority determines from where a switching command may be triggered, for example **REMOTE** via a control center or DIGSI 4 or **LOCAL** via the operator control panel of the device.

6.7.7 Switching Authority

The switching authority determines from where a switching command may be triggered, for example **REMOTE** via a control center or DIGSI 4 or **LOCAL** via the operator control panel of the device.

From the Device Front

In the case of devices with graphical display the switching authority is specified by the upper of the two keyswitches.

When the keyswitch is in a horizontal position (Local) local control is activated. In a vertical position (Remote) remote control is permitted.

Proceed as follows in the case of devices with 4-line display and without keyswitch:

- In the **MAIN MENU** select the **Control** menu item and change to the **CONTROL** submenu.
- There select the **Control Auth.** menu item and change to the **CONTROL AUTH.** menu.
- Enter the password for **non-interlocked switching** and confirm it with **ENTER**.
- Select **Remote** or **LOCAL** and confirm with **ENTER**.
- Confirm the operating response with **ENTER**.

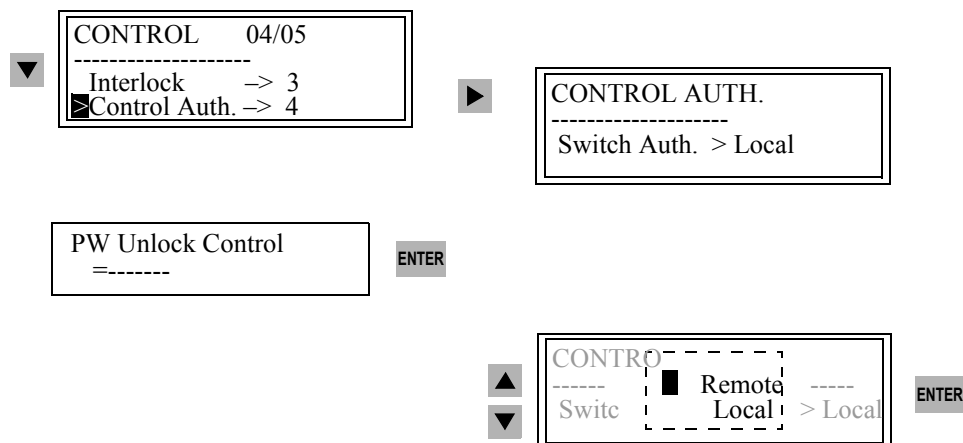

Fig. 6-61 Operating menu for the switching authority (example for non-interlocked switching mode)

From PC with DIGSI 4

For safety reasons the switching authority can only be changed directly locally via the operator control panel of the device, but not via DIGSI 4.

In order to switch from DIGSI 4

- The switching authority at the device has to be set to REMOTE or
- The check condition of the switching authority has to be inactive at remote control.

The switching authority is not transferred to DIGSI 4 until the moment in which the **Control** function is called up.

6.7.8 Switching Mode

If you have to switch non-interlocked, for example during commissioning, you can change the switching mode during operation.



DANGER

Non-interlocked switching requires a high qualification and exact knowledge of the plant conditions. Illegal switching operations can cause death or serious injuries and damage to property.

From the Device Front

In the case of devices with graphical display, the switching mode is specified by the lower of the two keyswitches. When the keyswitch is in a horizontal position (Interlocking OFF) non-interlocked switching is allowed. In a vertical position only interlocked switching is allowed.

Proceed as follows in the case of devices with 4-line display and without keyswitch:

- In the **MAIN MENU** select the **Control** menu item and change to the **CONTROL** submenu.
- There select the **Switch mode** menu item and change to the **SWITCH MODE** menu. The current setting is displayed.
- Enter the password for **non-interlocked switching** and confirm it with **ENTER**.
- Select **INTERLOCKED** or **NON-INTERLOCKED** and confirm with **ENTER**.
- Confirm the confirmation query with **ENTER**.

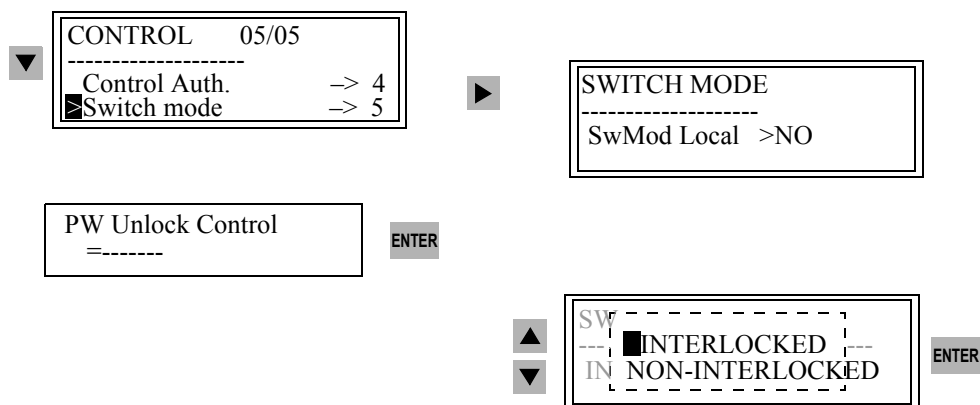

Fig. 6-62 Operating menu for the switch mode in the display

From PC with DIGSI 4

- Open the device in the **Online** mode.
- Double-click **Control** and double-click in the function selection on **Breaker/Switches**.
- In the dialog box select the **Non-interlocked switching** option and confirm with **OK** if you want to switch without any further test.
- De-activate the **Interlocked switching** option and confirm with **OK**, if the switching conditions are to be subject to the configured interlock conditions.
- Enter the password for **non-interlocked switching** and confirm it with **OK**.

The enable for further switching operations remains active until you close the **Devices** dialog box or have changed the switching mode.

6.7.9 Control Indications

In the course of system control, the device outputs indications which document the course, for example the end of a command or the reasons for a refusal. Table 6-3 explains these indications and their causes together with further indications on controlling device functions.

Table 6-3 Possible control indications

Indication text	Indication cause
System Error	Interruption by system error
Man. Overwrite OK	Manual overwrite carried out
Man. Overwrite Fail	Manual overwrite cannot be carried out
Control Abort OK	Command interruption carried out correctly
Control Abort Fail	Process cannot be interrupted because no command has been issued or the command runs in a different switching direction or interruption is not planned or configured
Control Executed	Command was executed and ended correctly
Control Failed	Refusal because the command number or the source of cause is not permitted
Interlocked	Refusal because the communication interface was blocked or the command object is blocked by a protective function
Switchgr. Interlocked	Refusal because the command is subject to field interlocking
Switch in Position	Refusal because the current switch position = command direction
Setting Error	Refusal because of a setting error, such as unknown command type
Not Authorized	Command from LOCAL refused because the command object is subject to switching authority which is set to REMOTE
Control Expired	Refusal because command is too old (expiry monitoring)
No Control Device	Information address is not configured as a command output
Config. Error	Refusal because no binary output is assigned to this object or the configured binary output does not exist in the device
Control Blocked	Refusal because an output block is set
HW: 1 to n error?	Refusal because a binary output to be controlled is already active (e.g. common contact relay by another command)
SW: 1 to n error?	Refusal because another binary output is already controlled
System Overload	No more free timers available
Upper Sett. Limit	For transformer LTC step commands, highest level already reached
Lower Sett. Limit	For transformer LTC step commands, lowest level already reached
Executing Control	New command is refused because a command is already executing
Command Timeout	Feedback indication missing
BinaryInp. Ignored	Input block set
Chatter active	Chatter block is active
Setting active	Refusal because parameter loading process is running
Status Change OK	Status command executed
Status Change Fail	Status command cannot be executed
Change OK	Tagging executed

Table 6-3 Possible control indications

Indication text	Indication cause
Change Failed	Tagging cannot be executed
Checking Interlock	Command is sent to the central unit to check system interlocking
Settings are OK	Parameter change was correctly accepted
Time Limit Expired	Parameter change was interrupted because time expired
Terminated-Pickup	Parameter change interrupted because a fault became active during parameter configuration
Restore Parameters	As a reaction to a fault recognized during parameter configuration the last active parameter set is activated again
Please Wait...	Initiated process running and requires some more time
Checking Settings	The changed parameters are checked before acceptance
Swgr. Feedback OK	Feedback: destination reached
Swgr. Feedback Fail	Feedback: destination not reached
Change Rejected	Parameter change was rejected (e.g. because time expired, or abnormal occurrence during parameter configuration)
Control OK	Positive conclusion indication for commands
Value Incorrect	Plausibility error in command

■

Communication

This chapter explains the most important terms and the basic procedure for configuring the communication connections between your SIPROTEC device, DIGSI 4 and control centers.

Contents

7.1	General	368
7.2	Establishing a Connection via Plug and Play	372
7.3	Establishing a Connection	374
7.4	Initializing a SIPROTEC 4 Device	376
7.5	Transmitting the Parameter Set	377
7.6	Direct Connection in Accordance with IEC 60870-5	378
7.7	Central / Remote Control	382
7.8	PROFIBUS FMS	391
7.9	Supplementary Protocols	439
7.10	Connection via Ethernet	446

7.1 General

DIGSI 4 provides several communication possibilities between the computer and the SIPROTEC 4 device.

- ❑ Communication via a direct connection,
- ❑ Communication via a modem line in connection with the optional software **DIGSI 4 Remote**,
- ❑ Communication via a PROFIBUS FMS network by means of the implemented PROFIBUS FMS functionality. If your device communicates with a SICAM control center, you require the full version of STEP 7, otherwise DIGSI 4 is sufficient.

For SIPROTEC devices from system firmware Version 4.2 up communication with a control center via the system interface is also possible on the basis of the PROFIBUS DP, DNP 3.0 and MODBUS protocols.

In addition DIGSI 4 allows the configuration of an Inter Relay Communication as well as a process bus link via submodules and PCUs which pass field information on to a process control device for some device types.

Further information can be found in the manual of your SIPROTEC 4 device.

Addresses

For the communication between DIGSI 4 and a SIPROTEC device as well as other communication, unique addresses have to be specified. Assignment is carried out by the user or by DIGSI 4 depending on the respective address.

An example configuration is shown in Figure 7-1. This figure also shows at which points within the communication system the addresses explained below are required.

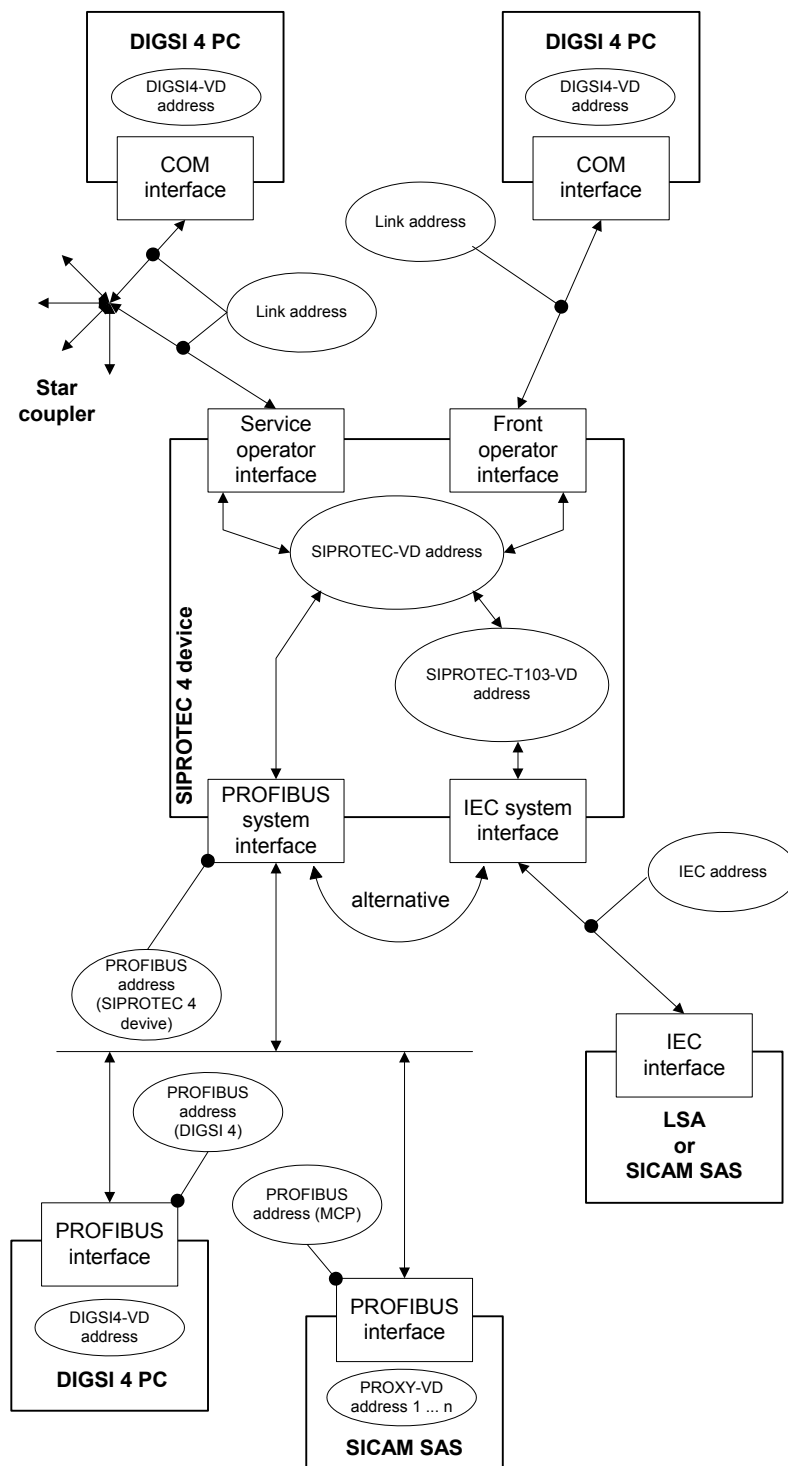

Fig. 7-1 Sample configuration

VD Addresses

A unique VD address (**Virtual Device address**) is assigned to every component within a plant or station. A component can be the device (e.g. SIPROTEC 4 device), the module of a device, or a software module (for example DIGSI 4). VD addresses are differentiated according to the type of component:

❑ **DIGSI4 VD address**

This address is used for unique identification of DIGSI 4 (i.e. the PC on which DIGSI 4 is operated) within a station or substation. The preset address can normally be used as it is. You only have to change this address if simultaneous access to the two operating interfaces of a SIPROTEC 4 device must be possible. In this case, enter a new address for one of the two DIGSI4 VD addresses used. To accomplish this, change to **DIGSI device configuration**, open the object **Interfaces** and change in the tab **VD addresses** the **DIGSI VD address**.



NOTE

As of now the interfaces is not prioritized so that access via the one interface can influence the simultaneous communication via the other (changes in the baud rate, transfer of parameters).

❑ **SIPROTEC-VD-Addresses (VD, Mirror-VD and redundant Mirror-VD)**

VD addresses are assigned automatically by DIGSI Manager. They exist only once in the entire project for objects of the type SIPROTEC 4 device and thus they unambiguously identify a real SIPROTEC 4 device. The VD addresses assigned by DIGSI Manager must be transmitted to the SIPROTEC 4 device in order to enable the communication with DIGSI Device Editor.

VD addresses may change if you save a project using the Reorganize option or directly via the menu item **File > Reorganize**.

After reorganizing a project, you should therefore compare the VD addresses in the SIPROTEC 4 device with the corresponding object. If the addresses are no longer identical, you must reinitialize the SIPROTEC 4 device.

You can also manually change addresses. DIGSI Manager will then verify your entries. Permitted addresses are between 10000 and 20000. DIGSI Manager automatically rejects addresses outside this range or addresses which are already assigned.

❑ **SIPROTEC-T103 VD address**

This address is used for unique internal identification of an IEC 60870-5 system interface of a SIPROTEC 4 device. It is assigned by DIGSI 4 and cannot be changed.

❑ **SICAM-Proxy VD address**

This address is used for unique identification of the image of a SIPROTEC 4 device within a SICAM SAS. It is assigned by DIGSI 4 and cannot be changed. A SICAM-Proxy-VD address is taken into consideration when the SICAM SAS is configured for every SIPROTEC 4 device participating in communication.

Except for the DIGSI4 VD address that the user might have to change, the VD addresses are initially not relevant to operation from the point of view of the user. They are only displayed for testing and diagnostic purposes.

IEC Address

This address is relevant in as far as a SIPROTEC 4 device has an IEC 60870-5 system interface. Within an IEC bus a unique IEC address has to be assigned to each SIPROTEC 4 device. A total of 254 IEC addresses are available for each IEC bus. Both the IEC address of a SIPROTEC 4 device as well as its assignment to a specific IEC bus are specified by you in DIGSI 4.

PROFIBUS FMS Address

This address is relevant in as far as a SIPROTEC 4 device has a PROFIBUS FMS system interface. A unique PROFIBUS FMS address must be assigned to each SIPROTEC 4 device in a PROFIBUS FMS network. A total of 254 PROFIBUS FMS addresses are available for each PROFIBUS FMS network. Both the PROFIBUS FMS address of a SIPROTEC 4 device as well as its assignment to a specific PROFIBUS bus are specified by you in DIGSI 4.

IEC Link Address

This address is relevant in as far as you want to implement communication via the rear or front operating interface of a SIPROTEC 4 device. If there is a point-to-point connection between the PC and SIPROTEC 4 device, use the address **1** as a rule. If a star coupler is used, a unique IEC-Link address has to be assigned to each SIPROTEC 4 device. You can assign addresses in the range from 1 to 254.

Operating Modes

Processing of the data of SIPROTEC 4 devices by means of DIGSI 4 is possible in the operating modes off-line or on-line.

There is no connection to the device in the **Offline** operating mode.

In the **Online** operating mode there is a connection to the device.

In this operating mode it is possible to:

- transfer parameter values from the temporary memory of the PC to the SIPROTEC 4 device,
- transfer parameter values from the SIPROTEC 4 device to the temporary memory of the PC and then save them in the permanent memory of the PC (see Chapter 4.4),
- transfer indications, measured values and fault records from the SIPROTEC 4 device to the temporary memory of the PC and then save these in the permanent memory of the PC (see Chapter 4.4),
- execute test functions,
- control the equipment and set taggings,
- Initiate a restart or a resume of the SIPROTEC 4 device,
- Set the date and time of the SIPROTEC 4 device.

In addition, the editing possibilities of the **Offline** operating mode are also available with the exception of access to saved measured values, indications and fault records.

7.2 Establishing a Connection via Plug and Play

Plug & Play is used to establish a direct connection to a SIPROTEC device for which you have not saved a parameter set in the PC. To this purpose you only require a DIGSI 4 project.

Proceed as follows:

- Establish a direct connection in accordance with IEC 60870-5 between the computer and the SIPROTEC 4 device. To do so use a free serial COM port at the computer and the operator or the service interface at the device.
- Click in the DIGSI 4 project view with the right-hand mouse button on a **folder** and open the **Plug & Play** dialog box via the **Device > Create device via Plug & Play** context menu.

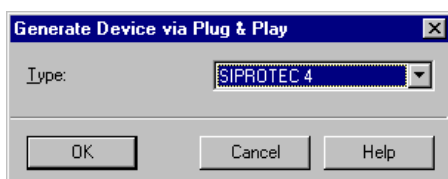

Fig. 7-2 Plug & Play

- Select the **type** of the device and click **OK**. The **Plug & Play** dialog box opens.

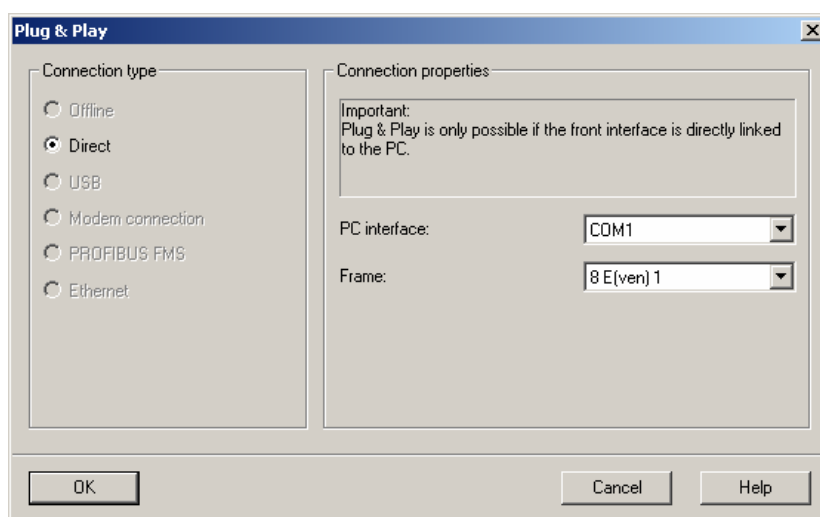

Fig. 7-3 Plug & Play

- From the **PC interface** drop-down list box select the name of the serial PC port to which the device is connected.
- From the **Frame** drop-down list box select the transmission format with which the connection is to be established.
- Click **OK**.

DIGSI 4 determines the device type, reads the parameter set from the SIPROTEC 4 device and recombines this with the default parameter set of the existing device type. It generates a **SIPROTEC 4 variant** and assigns the parameter set to it.

**NOTE**

In order to establish a Plug and Play connection, the default parameter set of the target device type must be installed on your computer. If this default parameter set is not installed, an error message is displayed. The connection establishment is canceled. Install the standard parameter set using the DIGSI 4 installation wizard and repeat the process.

**NOTE**

Not all the information of the device is available after the Plug & Play connection has been established (for example, there are no long texts from user-definable indications).

7.3 Establishing a Connection

If you want to establish a connection to a SIPROTEC 4 device whose parameter set is already contained on your PC, proceed as follows:

- In your DIGSI 4 project view select the **SIPROTEC 4 device** and open the **Open Device** dialog box via the context menu on **Open Object**.

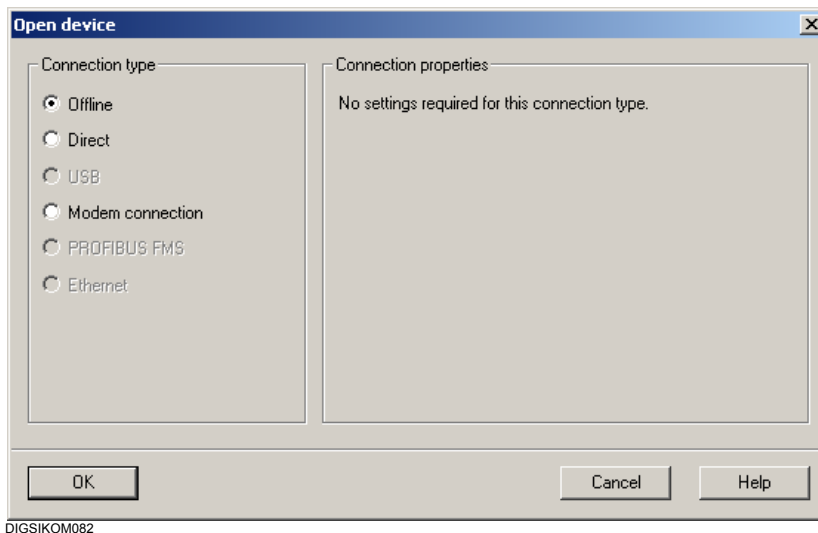

Fig. 7-4 Opening a device

- Select **Direct** if a direct connection to the device is to be established via a serial port on your PC, and select the **PC interface** and the **Device interface** from the drop-down list box.
- Select **USB** to establish a connection from the computer's USB port to the USB port of the SIPROTEC 4 device.
- Select **Modem connection** if a modem connection via the rear device interface is used as the communication connection to your device.
- Select **PROFIBUS FMS** if your device communicates via PROFIBUS FMS.
- Select **Ethernet** if your devices communicates via an Ethernet connection with DIGSI.
- Click **OK**.

Establishing a Connection

The connection to the SIPROTEC 4 device is established. During this operation, messages are displayed indicating the progress of connection. If a connection cannot be established, DIGSI 4 signals this fact.



DIGSIGB017

Fig. 7-5 Failed establishing of a connection

- Check whether the physical link between the computer and the SIPROTEC 4 device is correct. Eliminate the fault and then click **Repeat**.
- Click **Initialize**, if the SIPROTEC 4 device does not have a valid parameter set. Repeat the connection procedure.

Loading Parameter Values

While the connection is being established, the parameter values of the device in the PC are compared with the parameter values from the connected SIPROTEC 4 device. If inconsistencies arise, a message is displayed.

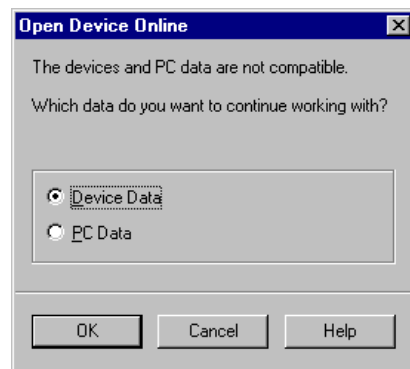

DIGSIGB018

Fig. 7-6 Different data in the device and computer

- Select one of the two options and click **OK**.
- The data stored in the files of your PC are not affected by your selection.

7.4 Initializing a SIPROTEC 4 Device

In order to be able to work with a SIPROTEC 4 device in the **Online** operating mode, the device must first be initialized **once**.

During initialization, the complete parameter set is transferred to the SIPROTEC 4 device. When a device is initialized, the VD address, which is used for unique identification of the device within a project, is transferred in addition to the parameter set. It is assigned automatically by DIGSI 4 while a **SIPROTEC 4 device** is being generated.

Proceed as follows:

- Prepare the **parameter set** for the SIPROTEC device in the **Offline** mode.
- In order to carry out initialization, establish a direct connection in accordance with IEC60870-5-103 between the computer and the device. Use a free serial COM port on the computer and the operator or the service interface on the device.
- Click with the right mouse button on the **SIPROTEC 4** device and open the **Initialize Device** dialog box via the **Initialize Device** context menu.

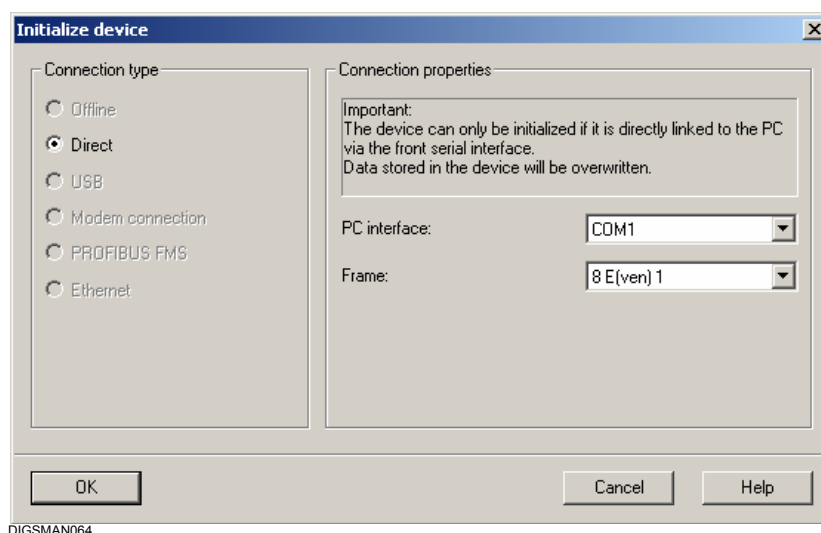

Fig. 7-7 Initializing a device

Setting Connection Parameters

Set the connection parameters.

- From the **PC interface** drop-down list box select the name of the serial PC port to which the device is connected.
- From the **Frame** drop-down list box select the transmission format with which the connection is to be established.
- Click **OK** to start the initialization.

The following actions occur:

- The connection to the device is established.
- The data is transferred to the device.
- A restart of the device which is logged on in the device display is initiated.
- The connection is closed automatically.

7.5 Transmitting the Parameter Set

All values of a parameter set stored in files can be transferred to the memory of a SIPROTEC device that has already been initialized. You can use any of the available communication links to that end provided that the device is equipped with the required ports. DIGSI checks the consistency of the parameter set from the files and the parameter set of the connected SIPROTEC device. Incorrect settings caused by the conversion from primary and secondary values are automatically reset to the minimum value. An error message is then displayed telling you that the parameter set could not be transmitted. You can view the setting values concerned in the **Report** window.

Before it is transmitted, the size of the parameter set is calculated. A message box will inform you if the size exceeds the maximum memory space which is available for this parameter set in the SIPROTEC 4 device. The parameter set is not transferred to the device. You must first try to reduce its size. To this end, you should check whether you can delete some of the user-defined information items. Multiple activated functions, such as the protection threshold, contribute to the size of the parameter set. Reduce the amount of data in DIGSI Device Editor and check the size by clicking **File > Save** in the menu bar. If no message is displayed, the size of the parameter set is within the allowed limits.

Proceed as follows:

- Right-click an object of the type **SIPROTEC x device** or **SIPROTEC x variant**.
- Click **Transmit parameter set** in the context menu. The **Transmit parameter set** dialog box opens.
- Select the desired connection type. If you have selected the option **Direct**, you must also specify the PC port and the device port to be used for the communication link. You can also define whether the connection is established via a channel switch. This requires, however, that a SIPROTEC device has already been assigned to a channel switch in DIGSI Manager.

If you have selected the **USB** option, you may have to select one of the SIPROTEC 4 devices which are currently connected to the PC's USB port.

Two Ethernet interfaces may be installed in the 7SJ80 and 7SK80 devices. If you have selected the **Ethernet** option for one of these devices, you must also specify to which of the two ports the PC is connected.

A modem connection can generally not be used for this purpose.

- Click **OK**. The connection is being established.
- If the password for the parameter set is activated, you will be prompted to enter it before the setting values are transferred. **Enter password** dialog box
- Enter the correct password into the **Password** field and click **OK**. If the password is correct, the parameters are transmitted. If not, an error message will appear. After the data transfer is complete, the connection is closed automatically.

7.6 Direct Connection in Accordance with IEC 60870-5

Proceed as follows in order to establish and configure the direct connection between the PC and the device via a serial port:

- Install the hardware.
- Set the communication parameters.
- Establish the connection, if appropriate via Plug & Play.
- Close the connection manually.

In the case of a direct connection in accordance with IEC 60870-5 hardware installation is limited to connecting a common connecting cable to the two connection users. Use the 7XV5100-4 cable to this purpose. The wiring diagram can be found in Appendix A.4.

- Connect one end of the cable to a free serial port on the computer and connect the other end of the cable to the operator interface or the service interface of the device.

7.6.1 Setting Communication Parameters

The communication parameters are preset in DIGSI 4 so that they can be used for normal operation.

If you nevertheless need to change the values:

- Change the values of the respective communication parameters **offline** and initialize the SIPROTEC 4 device with the new settings. Proceed as follows:
- First establish a connection to the SIPROTEC 4 device with the currently valid settings and change the values of the corresponding communication parameters in the **Online** operating mode. Transfer the new settings to the SIPROTEC 4 device.

Proceed as follows:

- Open the device in DIGSI 4 and double-click **Interfaces** in the data window. The **Interface Settings** dialog box is displayed.
- Select the **Serial port on PC** tab.

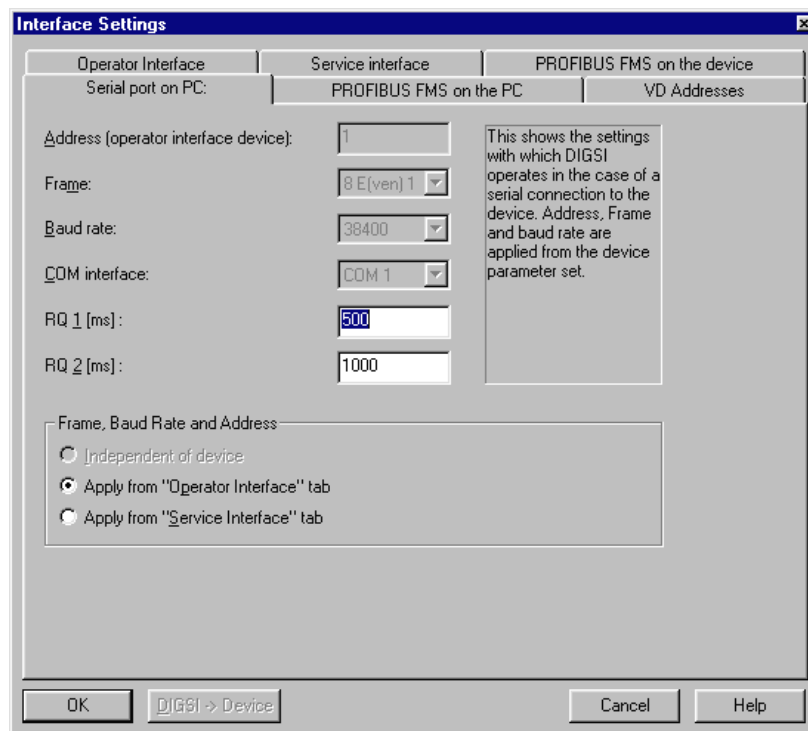

DIGSIKOM060.GIF

Fig. 7-8 Interface settings, Serial port on PC tab

- In the **Frame, Baud rate and Address** section select **Apply from "Operator Interface" tab** or **Apply from "Service Interface" tab**, depending on which interface of your device is connected to the PC. This ensures that the communication parameters of the PC and SIPROTEC 4 device have identical settings.

The settings for **Address (device operator interface)**, **Frame** (parity) and **Baud rate** are taken from the **Operator interface** tab or from the **Service interface** tab depending on the option selected. They cannot be changed at this point.

The setting for the **COM port** used on the PC is taken from the **Open device** dialog box. It cannot be changed at this point.

PC Port and Service Port

The setting possibilities of the **operator interface** and **service interface** tabs are identical with regard to the communication parameters.

- Change to the **Operator Interface** tab.

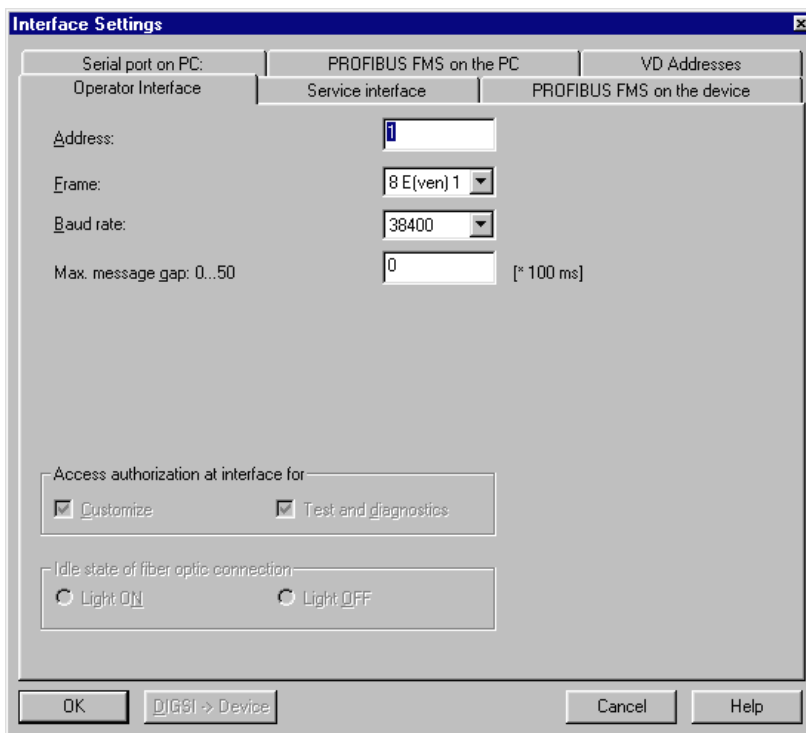

DIGSIKOM062

Fig. 7-9 Interface Settings, Operator interface tab

- Enter a value for the IEC link address in the **IEC-Link Address** box. If a direct link between the PC and the device is established, enter the default value 1. If you are using a hub, you must assign a unique IEC link address to each SIPROTEC 4 device. You can assign addresses in the range from 1 to 254.
- Select the parity setting in the **Frame** box.
- Select the baud rate setting in the **Baud rate** box.
This entry is used for the normal establishing of a connection. In the case of a connection being established in the context of the SIPROTEC 4 device being initialized or in accordance with the Plug & Play process, this value corresponds to the transmission speed with which an attempt is made to establish a connection. If this attempt is not successful, another attempt is made with lower baud rate. This procedure is repeated until the link is established successfully or the preset baud rate has been reached.
- Enter a value for the maximum message gap in the **Max. message gap** box. This value multiplied by 100 ms results in the maximum permissible interval between two transmitted bytes. The parameter is only relevant for communication via a modem line.

Light OFF is the default for the sign idle state for optical fiber connections.

- Select the option **Light ON** if you want to change the sign idle state.

7.6.2 Establishing a Direct Connection between DIGSI 4 and the Device

Establish the connection between your device and the PC via

- Plug & Play
- Open Device in the **Direct Online** operating mode.

The procedure is described in Chapter 7.2 and Chapter 7.3.

7.6.3 Closing a Direct Connection

You have various possibilities of closing an existing direct connection.

Close a SIPROTEC 4 Device

- Close the opened device via **File > Close**.

The direct connection is closed automatically. If changes to the parameter set have not been saved, the confirmation box is displayed.

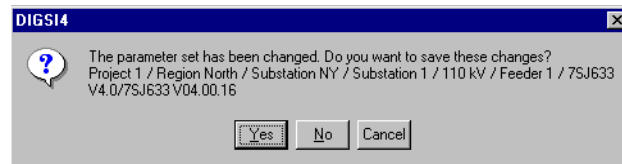

DIGSIGB057

Fig. 7-10 Confirmation box after a parameter set has been changed

- Click **Yes** if you want the changed parameter set to be saved before the connection is closed.
- Click **No** if you want to close the connection without saving the parameter set.
- Click **Cancel** to abort the whole process. The connection will not be closed, the parameter set is not saved.

Terminating Device Editing

- Close the device editing via **File > Close**.

An existing direct connection is closed automatically. All the opened devices are closed or a confirmation box is displayed for every device asking whether the parameter set is to be saved.

7.7 Central / Remote Control

7.7.1 Introduction

The central or remote control using DIGSI 4 is a comfortable tool that allows users to quickly operate SIPROTEC protection relays which are located in a far distance or which are difficult to access. Also, it enables reading fault data and fault records stored in the relay in order to quickly diagnose a fault. There are different ways of implementation that have to be adapted to the local communication structures, to the different types of protection relays and above all to the safety requirements.

Central operation is used wherever the devices in a system are assigned to a fixed "control center". A PC gives the operator access to all devices without having to leave the control center.

Remote control is used if several persons in different locations want to access devices in installations located at different distances. The connection is established via the public telephone network, corporate networks or dedicated lines using dial-up modems or dedicated line modems.

7.7.2 Central Control

Easy central control requires all devices to feature a suitable serial port that may be designed differently in physical terms. A specified data protocol makes sure that all devices "speak the same language" while they can be distinguished from each other by their address. The devices are connected to a central device using a point-to-point connection or a data bus. Depending on the topology and safety requirements, either electrical RS485 structures, Ethernets or optical fiber structures are used.

7.7.3 Remote Control

The remote operation of several devices in an installation always requires that a central operation already exists. When configuring the central operation it is thus extremely important to allow for retrofitting of the remote control with modems at a later time.

The selection of the modems primarily depends on the available transmission lines and facilities but also on the protection relays to be operated. Devices that process great amounts of data (e.g. SIPROTEC 4) should be operated via fast modems (e.g. ISDN or analog 56k). However a fast modem used in combination with poor transmission lines does not make much sense. It is recommended to use the same modem types at both ends of the transmission path.

The Ethernet (intranet or internet) is used increasingly for fast data transmission. Special "Ethernet modems" or the "serial hub" are available to this end.

7.7.4 Analog Modems

Analog modems can be used worldwide in any kind of analog telephone networks.

The word modem is made up of the words **modulate** and **demodulate**. A digital signal is modulated on a carrier signal and regained at the remote end via demodulation. The transmission of a character to the remote station that undergoes this process takes approx. 60-80 ms and is constant. The transmission of a byte (8N1=10 bits) at 9600 bauds (bit/s) takes only about 1 ms, i.e. the total speed of data transmission is not doubled by doubling the baudrate. This explains the relatively long transmission times of SIPROTEC 4 since the devices have to transmit many short messages with acknowledgement of the remote end.

7.7.5 ISDN Modems (Terminal Adapter/Controller)

"ISDN modems" can only be used in digital communication networks such as Euro-ISDN.

Actually, using the word 'modem' is not correct in this context as no demodulation takes place. This is why these devices are also called terminal adapter or controller. There are no modulation and demodulation times as in analog modems. The transmission of a character to the remote station takes only about 10 ms and is also constant. With 64 kbauds transmission path the SIPROTEC 4 relays can be operated comfortably at 57.6 kbauds.

7.7.6 Ethernet Modems

The Ethernet has become widely known owing to the globe-spanning internet and has been commonly used in the business world for quite a while. Even small companies are increasingly using local network structures networking their sites via secure VPN connections (**V**irtual **P**rivate **N**etwork). Most effective "firewalls" secure the access to the internet by means of password protection and sophisticated encryption methods.

7.7.7 SIPROTEC 3 Devices

The SIPROTEC 3 devices with baudrates of up to 19.2kb are often used together with the recommended modems up to 28.8 kb.

The modems supported by the DIGSI 3 software (MT2834 and LOGEM 928 or LGH28.8D) with the data format 8E1 ensure the safe, fast and comfortable operation of the V3 protection relays.

When DIGSI 3 power system data including remote control are converted to DIGSI 4, a modem driver has to be installed and the modem settings need to be adjusted.

7.7.8 SIPROTEC 4 Devices

The introduction of the new SIPROTEC 4 product range and the DIGIS 4 operating program has boosted transmission rates to up to 115 kb increasing also the amount of transmitted data drastically. Fast analog modems, e.g. the MT5600 (7XV5800-3xA00), the even faster ISDN modems LOGES 64k (7XV5810), the new Ethernet modems or serial hubs largely meet these requirements. In order to operate the SIPROTEC 4 devices comfortably, we recommend using digital ISDN or Ethernet modems.

7.7.9 SIPROTEC 3 and 4 Devices

If an installation with SIPROTEC 3 devices is to be expanded by SIPROTEC 4 devices and if 28.8 kbaud modems are already in use, the SIPROTEC 4 relays have to be set to the same transmission parameters (e.g. 9600 8E1). Even the use of a faster modem, it is not possible to use the maximum baudrate of 19200 bauds (SIPROTEC 3) since all devices **must** work with the same baudrate.

But the SIPROTEC 4 relays can be operated comfortably nevertheless by retrofitting an "active mini star coupler" 7XV5550-0xA00, faster modems and DIGSI 4. First, drag all devices and the active mini star coupler (channel switch) into the Device Manager of DIGSI 4 or create them anew. Then install the new modems and adjust the modem settings (see catalog sheet 7XV5550).

Alternatively, it is possible to use several Ethernet modems or serial hubs in the installation.

DIGSI 4 sends the data with the highest permissible baudrate (e.g. 57 kbauds 8N1); the selected substation modem forwards the messages without gap (buffered) using the baudrate and the data format of the connected protection relays (e.g. 9600 bauds 8E1).

7.7.10 V1/2 Protection Devices

V 1/2 protection relays can also be dragged into the Device Manager or created in DIGSI 4.

Since these protection relays can not be addressed, an "active mini star coupler" (channel switch) is required and one optical plug converter each for the front port for the central or remote control of several protection relays.

Again, the alternative is to use several Ethernet modems or serial hubs (7XV5655).

A modem or hub is required for each protection relay. The front port of the protection relay can be connected directly to the serial RS232 interface of the modem/hub.

7.7.11 Data Format/Secure Transmission

The analog modem MT5600 and many commercial "internet modems" no longer support our so far preferred data format 8E1, or have problems supporting it.

This is increasingly also the case for standard software products and operating systems such as Windows.

The data format 8N1 (8 data bits, no parity, 1 stop bit) has established itself as the standard.

The missing parity bit (error detection bit) has been **more than replaced** by new error detection and elimination features in data transmission through modem lines.

To follow this trend, SIPROTEC 4 devices and DIGSI 4 have been upgraded for this format, and provided with even better error detection features such as checksum calculation (CRC32).

For future installations, we therefore recommend to use the standard 8N1 data format and the maximum transmission rate of 57.6 kbauds.

7.7.12 Approvals

Analog modems are commonly used worldwide. In order to be operated in a public communications network, the modem also needs a country-specific approval. Most modems are prepared and suitable to operate in different networks but still they require a valid approval. Please pay attention to the approval when placing your order. Private networks, e.g. corporate networks, usually do not require an approval.

Digital modems or network adapters are designed for use on a limited national or international scale (e.g. Europe) and as such they can only be operated in this region. The correct approval must also be considered in this case.

7.7.13 Selection Criteria

As the above specifications show, there are several ways we can achieve our target depending on topology, desired comfort and safety requirements.

The modems play a central role in this context, particularly regarding their application in substations and their transmission behavior in critical applications, e.g. of gap-intolerant V3 devices.

We have worked out the most viable solutions for you and tested them with our recommended components DIGSI, modems, star coupler and various converters.

The results of our work can be viewed in the "SIPROTEC Download Area" on the internet providing detailed application examples (some selected examples are given in section 7.6.15). They are intended to help you choose the right components, set up the system in short time and commission it safely.

www.siprotec.de > Applications

The following presents some important criteria for the selection of communication equipment.

Central or Remote Control?

If you opt for the central operation, you should make provisions for a future enlargement by remote operation. Central operation is often only the first step.

Optical Star Structure or Electrical RS485 Bus?

The optical star structure is the most fail-safe way of device communication in substations. It is recommended for applications where utmost importance is attached to security standards or if communication takes places over great distances or spans several buildings.



NOTE

Not all devices are equipped with FO interfaces, but appropriate converters are available (see Accessories)

The RS485 bus is preferably used inside a building or room to connect devices in one or more different cabinets. An optical isolation to the substation modem **should always** be provided for. Not all devices are equipped with a RS485 interface (see Accessories).

Are the Protection Relays Addressable?

All addressable SIPROTEC 3 and SIPROTEC 4 protection relays can be operated on a modular 7XV5300 star coupler, 7XV5450 mini star coupler or on the RS485 bus.

Central or remote operation of not addressable V1 or V2 protection relays can only be achieved via a 7XV5550 active mini star coupler or Ethernet modems/7XV5655 hubs.

Do the Protection Relays Tolerate Gaps?

If all devices are gap-tolerant, e.g. all SIPROTEC 4 devices or the 7SA511/7SA513 version V3.2x and higher, they can be operated using nearly any modem via star coupler or RS485 bus (see the below note).

If other devices are installed, our recommended modems 7XV5800/7XV5810 must be used.

Which Modems Are Recommended?

If only SIPROTEC 4 devices are installed, we recommend analog 56k, ISDN or Ethernet modems depending on which telephone system is used. The communication system must enable the fast transmission.

If, for instance, SIPROTEC 3 protection relays are used with a maximum speed of 19.2 kb or if transmission lines are poor, it is equally possible to employ the "slow" analog 28.8 kb modems.

We recommend our own components, especially the modems, since we have tested them and know about any weak spots. Should problems occur nevertheless, you can contact our Support who will help solve the problem (see below note).

Where Do I Get Support?

Our "SIPROTEC Download Area" on the internet contains detailed application examples (some selected examples are given in section 7.6.15) to help you select the right components, quickly set up the system and safely commission it.

www.siprotec.de > Applications

If Nothing Works Anymore

See **Hotline** in the Preface of this manual.

**NOTE**

The support by our Customer Care Center (Services) is limited to the modems 7KV5800 and 7XV5810 recommended and tested by us since we are not familiar with the manufacturer specific settings of other modems and can not test them either.

7.7.14 Application Examples

The figures 7-11 to 7-13 show some selected application examples:

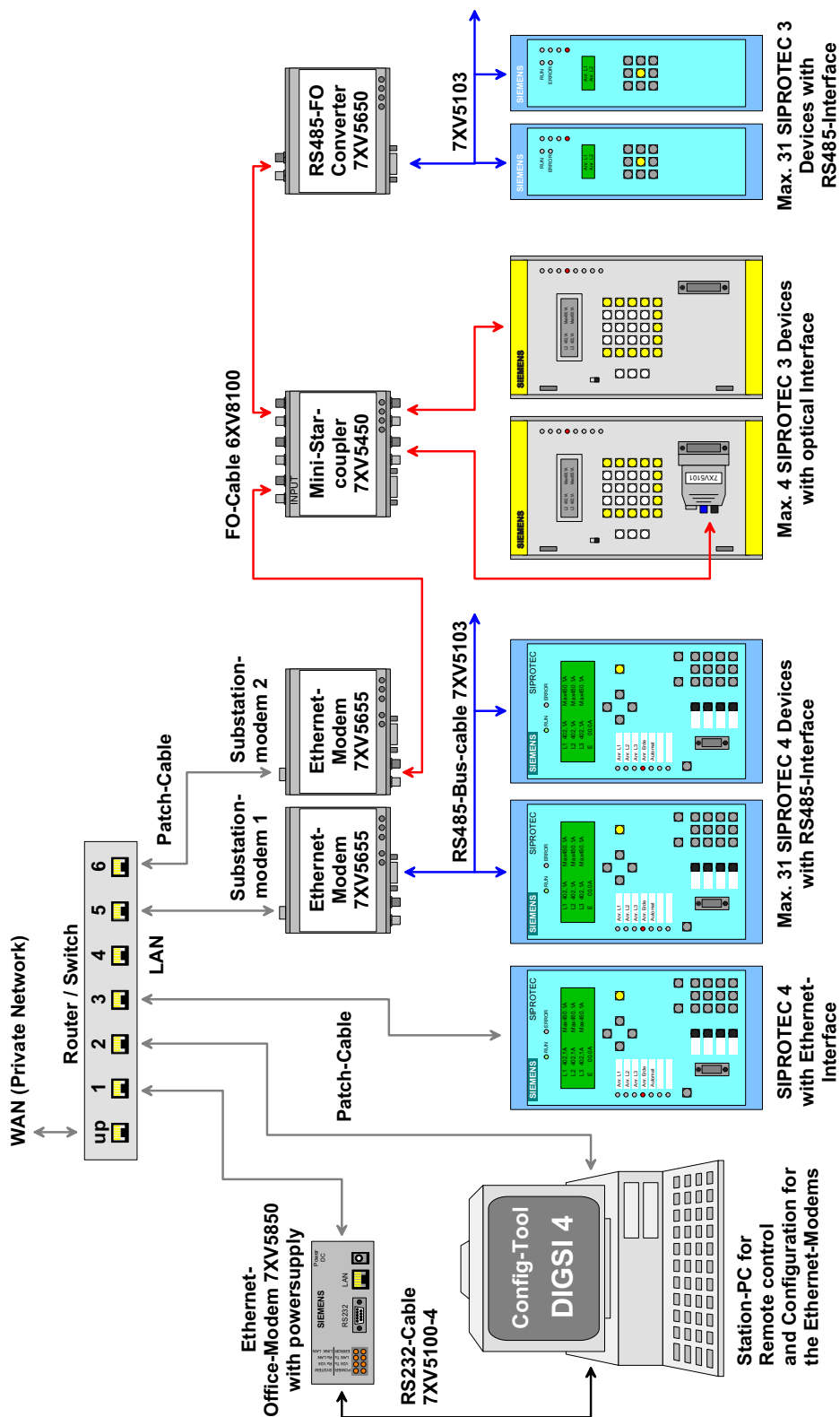

APPL_A_DIG4_SIP3-4_Ethernet-Modem_en_1.pdf

Fig. 7-11 Remote control of SIPROTEC 3/4 devices over Ethernet modem

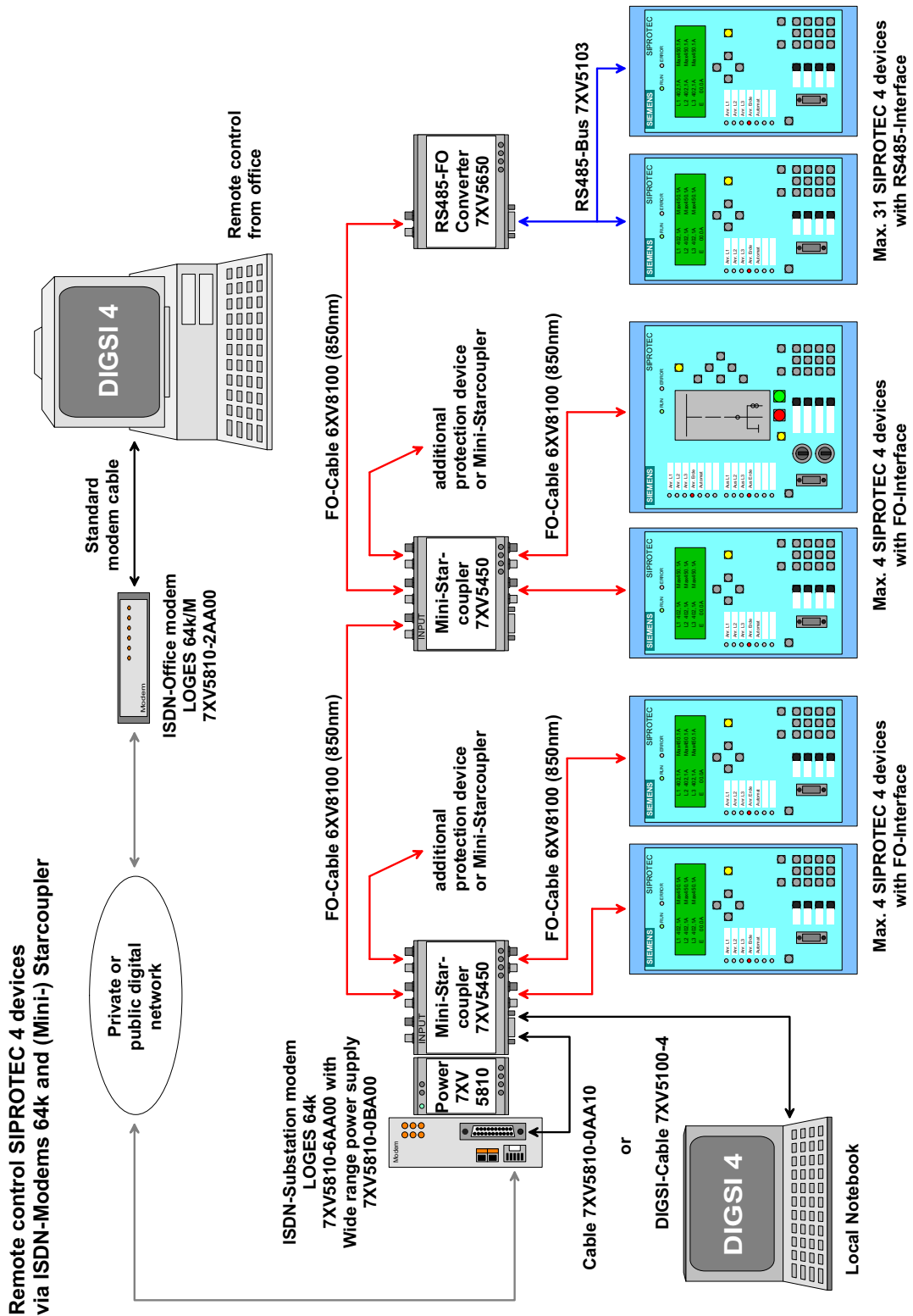

APPL_E_DIG4_SIP4_LWL_KE64K_KE64k_1.pdf

Fig. 7-12 Remote control of SIPROTEC 4 devices via ISDN-Modems 64k and (Mini-)Star coupler

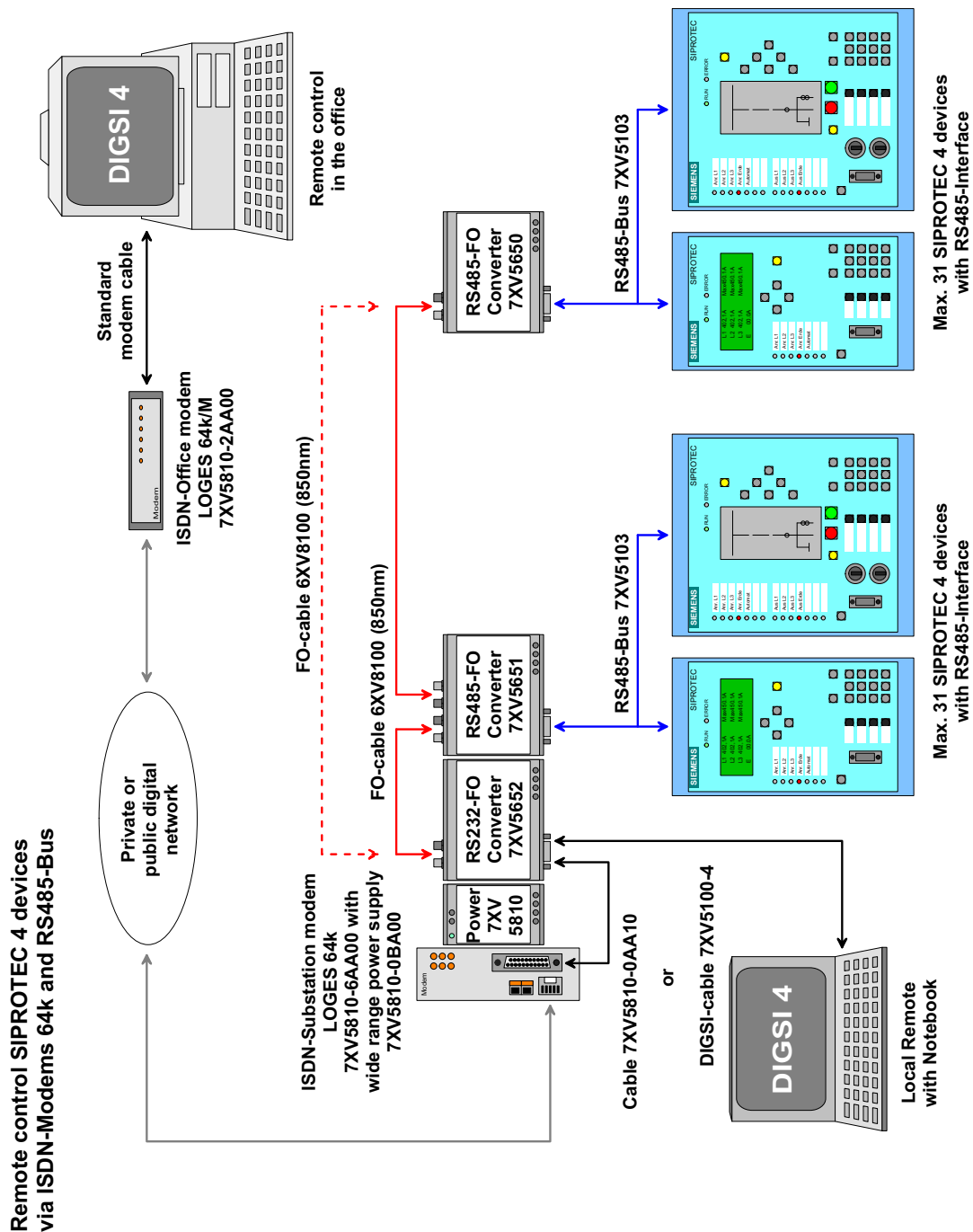

APPL_A_DIG4_SIP4_RS485_KE64k_KE64k_oH_en.pdf

Fig. 7-13 Remote control of SIPROTEC 4 devices via ISDN-Modems 64k and RS485-Bus

7.8 PROFIBUS FMS

Variants

We differentiate between the following variants:

- PROFIBUS FMS with SIMATIC NET software **05/2000 + SP2**; see Chapter 7.8.1
- PROFIBUS FMS with SIMATIC NET software **11/2002 + SP1**; see Chapter 7.8.2
- Procedure with SIMATIC NET NCM PC Edition; see Chapter 7.8.3

7.8.1 PROFIBUS FMS with SIMATIC NET Software 05/2000 + SP2

Operations

Proceed as follows in order to establish and configure communication between the PC and device via a PROFIBUS FMS:

- Install the hardware.
- Install the software for CP 5613
- Create a new master system
- Insert SIPROTEC 4 FMS Slave into the master system
- Save the settings
- Export the NCM database
- Set the programming device/PC interface
- Prepare operation without a SICAM station
- Prepare operation with a SICAM station
- Check and modify the variable addresses and lengths
- Establish the PROFIBUS FMS connection
- Close the PROFIBUS FMS connection

7.8.1.1 Installing Hardware

In order to implement communication via PROFIBUS FMS the **CP 5613** communications processor interface card is required. For information on installing the card as well as on the physical connection to the PROFIBUS FMS network please refer to the documentation on the **CP 5613** communications processor.

7.8.1.2 Installing the PROFIBUS FMS driver and COM PROFIBUS

Install the driver for the **CP 5613** communications processor and the **COM PROFIBUS** program for configuring communication via PROFIBUS FMS.

Proceed as follows:

- Place the **SIMATIC NET Software (05/2000 + SP2)** CD in the CD-ROM drive of your PC and start the **setup.exe** file.
- Click **Install SIMATIC NET Software** and follow the instructions of the installation program.
- Select **PB FMS-5613 V2.1** in the **SIMATIC NET Setup: Components** dialog box and click **Next**.

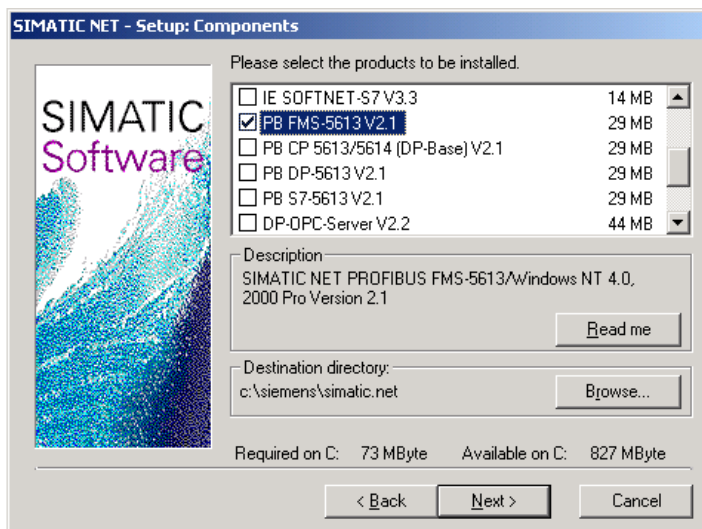

DIGSIKOM074a.gif

Fig. 7-14 SIMATIC NET Setup: Components dialog box

- Restart the operating system after installation has been completed successfully.



NOTE

If you would like to use the communications processor **CP 5613** together with **SIMATIC NET Software (05/2000 + SP2)**, you have to install a hotfix from a disk. For this hotfix, please contact your A&D sales representative.

Installing Drivers in the System

During installation of the SIMATIC NET software, the drivers for the **CP 5613** communications processor are copied onto the hard drive of the PC. Install this driver in the system so that you can access the **CP 5613** communication processor.

- Click in the Windows start menu on **Settings > Control Panel**. Double-click in the **Control Panel** Window on the **PG/PC interface** icon.

The **Set the PG/PC Interface** dialog box is opened.

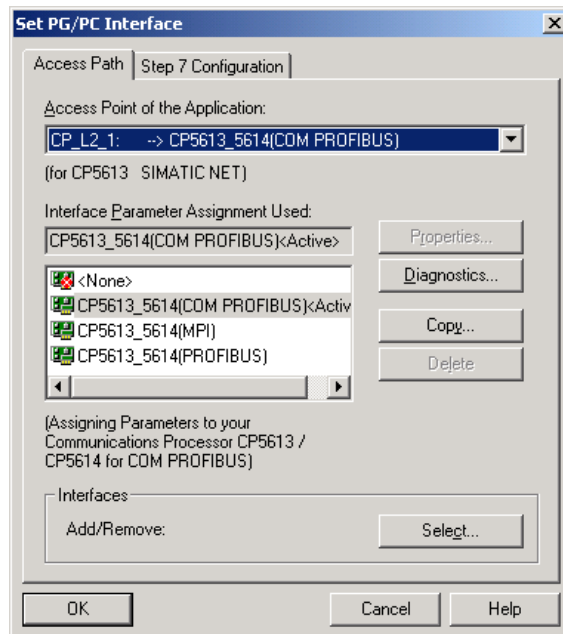

DIGISKOM014a.gif

Fig. 7-15 Setting the PG/PC interface

- Click **Select**.

The **Installing/Uninstalling Interfaces** dialog box is opened.

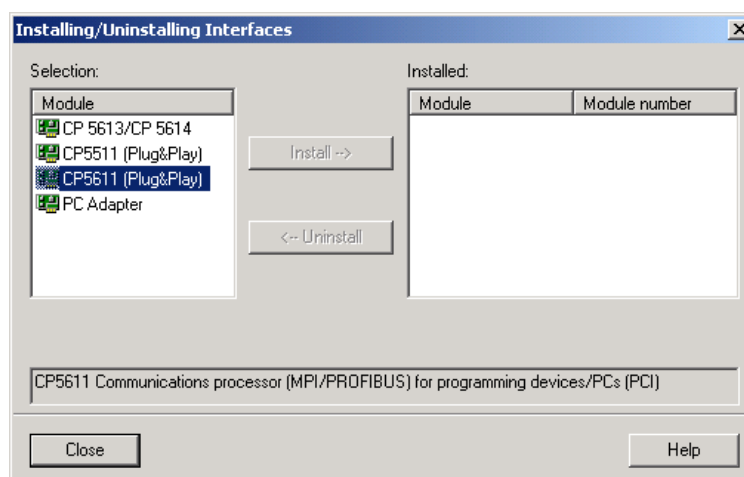

DIGISKOM075a.gif

Fig. 7-16 Installing/Uninstalling interfaces

- Select the entry **CP5613/CP5614** in the **Select** box and click **Install**.
- In the subsequent dialog box, select the model name of the installed communications processor.
- Click **OK**.

The drivers are installed. The resources assigned by Windows are displayed in an indication box after installation has been completed successfully.

- Click **Close** in the **Installing/Uninstalling Interfaces** dialog box.

A query appears regarding the changed settings. However, as further settings still need to be entered, it doesn't make much sense to restart the system at this point.

- For this reason, click **Cancel**.
- Click **OK** in the **Set the PG/PC interface** dialog box. The dialog box closes.

7.8.1.3 Creating a New Master System

Configuration of the **CP 5613** communications processor is carried out by means of the **COM PROFIBUS** program. For details please refer to the COM PROFIBUS manual. On the **SIMATIC NET Software (05/2000 + SP2)** CD you will find the version COM PROFIBUS V5.0. However, Windows 2000 users need the version V5.1. To obtain COM PROFIBUS V5.1, please contact your A&D sales representative.

DIGSI 4 functions in the PROFIBUS FMS network as a master. Since DIGSI 4 is connected to the PROFIBUS FMS network via the **CP 5613** communications processor, a new master system is first created for this card.

Proceed as follows:

- Start **COM PROFIBUS**.
- Drag & drop the FMS master CP5613/CP5614 from the selection list onto the working area (see Figure 7-17).
- Select **Object properties...** via the context menu:

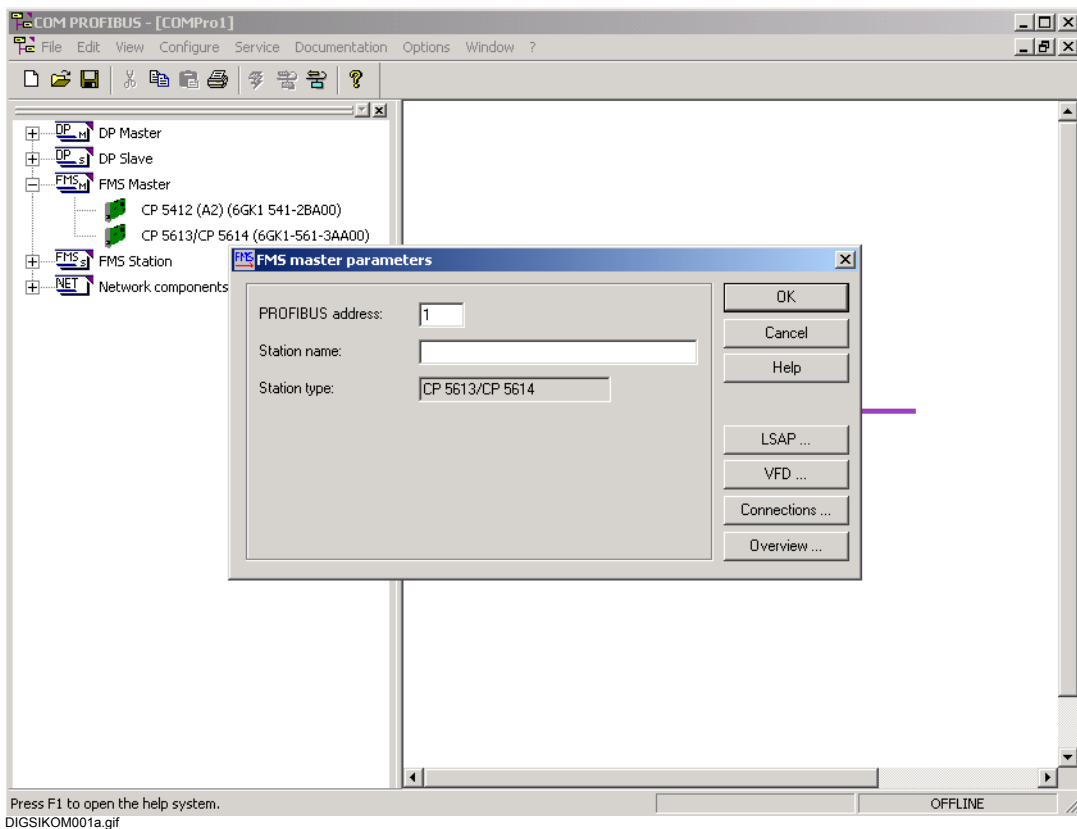

Fig. 7-17 New master system

Specifying the Bus Address and Station Name

- Select a PROFIBUS address and the station name in the **FMS master parameters** dialog box. Please select only even addresses (in this case "2").

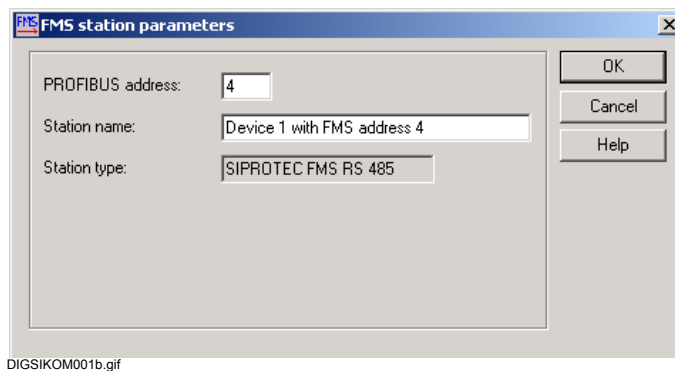

Fig. 7-18 FMS master parameter

- Click **OK** to apply your entries.

7.8.1.4 Inserting a SIPROTEC 4 FMS Slave in the Master System

SIPROTEC 4 devices which communicate with DIGSI 4 function in the PROFIBUS FMS network as slaves. You must therefore add a SIPROTEC 4 FMS Slave into the master system for each device.

Proceed as follows:

- Double-click the SIPROTEC 4 device in the selection list to move it to the working area. Select the symbol with the type of connection which you would like to use.

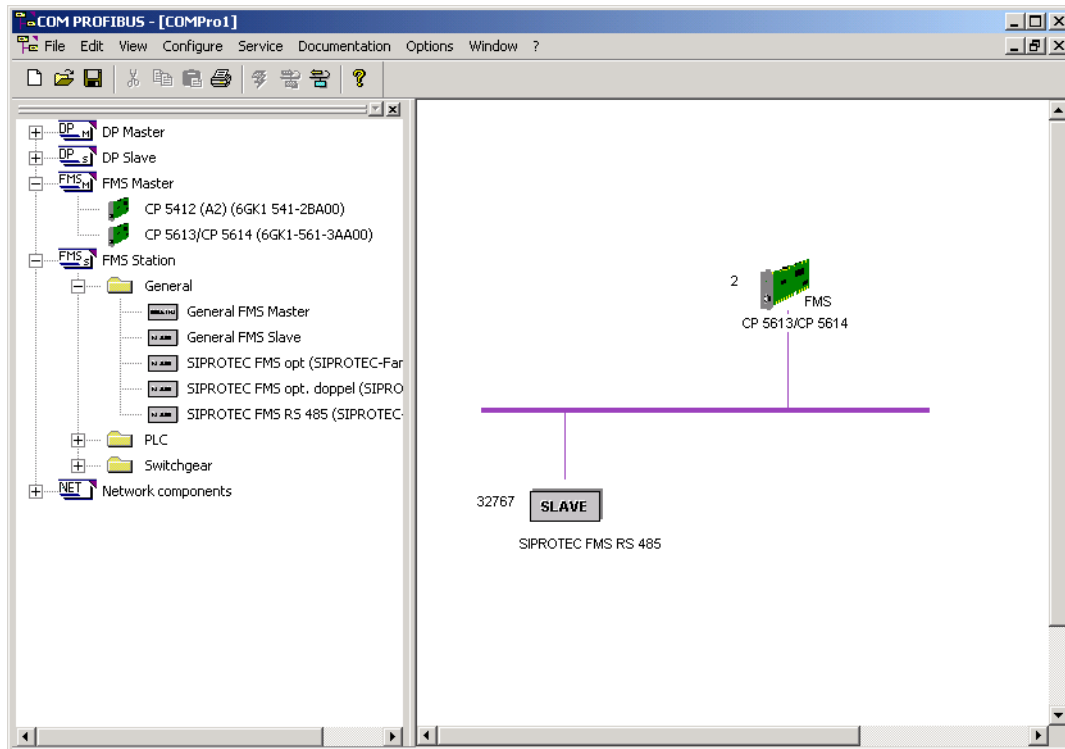

DIGSIKOM004a.gif

Fig. 7-19 SIPROTEC 4 device inserted as a slave

- Select **Object properties...** via the context menu.

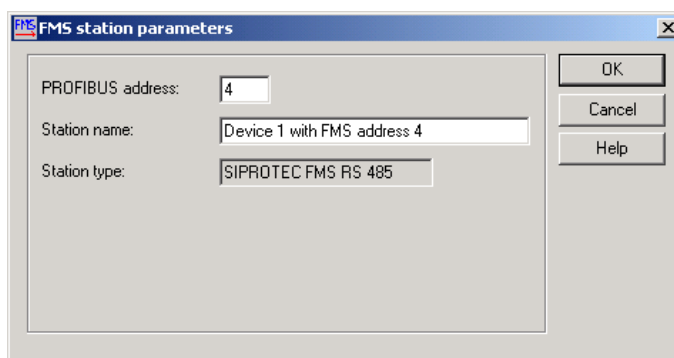

DIGSIKOM001b.gif

Fig. 7-20 FMS Station parameter

- Select a PROFIBUS address and the station name in the **FMS station parameters** dialog box. Please select only even addresses (in this case "4").



NOTE

Make a note of the PROFIBUS address. You require it in order to set the communication parameters in DIGSI 4 (see Chapter 7.8.1.8 and Chapter 7.8.1.9).

- Click **OK** to apply your entries.

Establishing a Connection

- Select the symbol CP5613/CP5614 in the working area.
- Select **Object properties...** via the context menu.
- Click **Connections** in the **FMS master parameters** dialog box.

The **Edit FMS Connections** dialog box is opened.

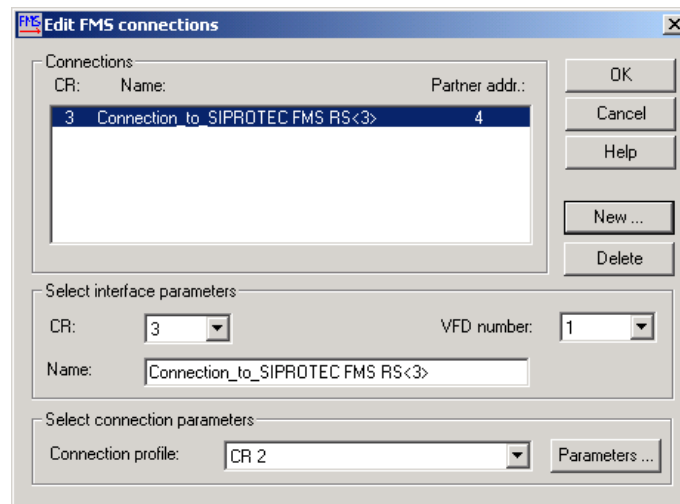

DIGSIKOM010a.gif

Fig. 7-21 Editing FMS connections

- Click **New**.

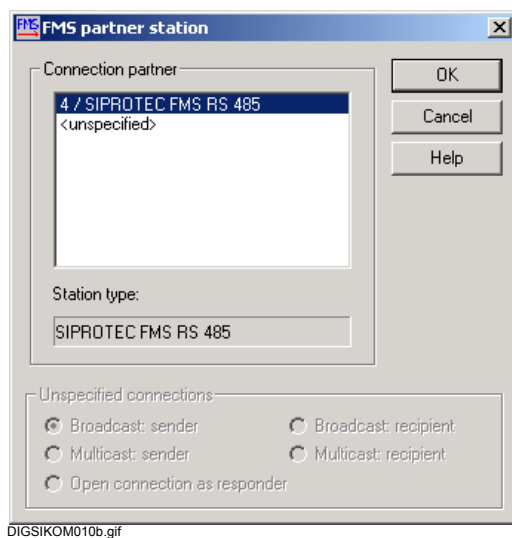

Fig. 7-22 Select FMS partner station

- Select the FMS partner station which you created.
- Accept the values with **OK**. The dialog box closes.

**NOTE**

Make a note of the value for the communication reference. You require this value in order to set the communication parameters in DIGSI 4 (see Chapter 7.8.1.8 and Chapter 7.8.1.9).

- Create the required SIPROTEC 4 FMS slaves for all the devices in the PROFIBUS FMS network.

7.8.1.5 Saving Settings

Save the configured settings of the master system.

Proceed as follows:

- Use **File > Save As** to open the **Save As** dialog box.

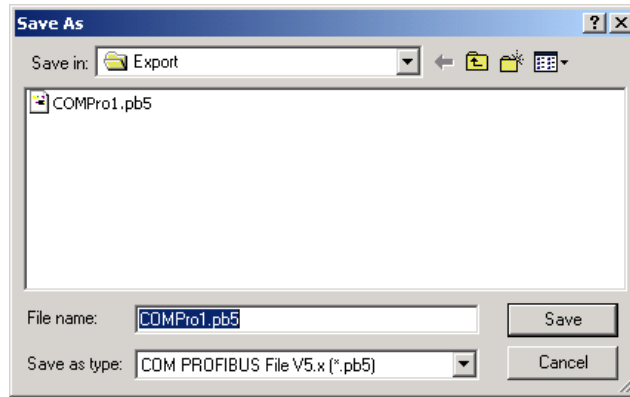

DIGSIKOM012a.gif

Fig. 7-23 Save As

- Enter a name with the extension **PB5** in the **File name** box. Select the drive and directory and click **OK**.

The settings are saved.

7.8.1.6 Exporting the NCM Database

The configured settings must exist as an NCM database in order for the **CP 5613** communications processor to process them. You must therefore export the settings as an NCM database.

Proceed as follows:

- Use **File > Export > NCM File** to open the **Save As** dialog box.

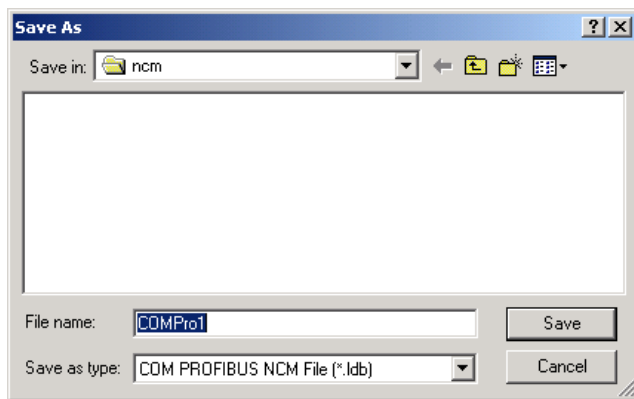

DIGSIKOM013

Fig. 7-24 Saving file as

- Enter a name with the extension **ldb** in the **File name** box. Observe the DOS conventions. Select the drive and directory and click **Save**.

The settings are saved as an NCM database.

7.8.1.7 Setting the PG/PC Interface

Transfer the configured data of the master system to the NCM database in the **CP 5613** communications processor.

Proceed as follows:

- Click in the Windows start menu on **Settings > Control Panel**. Double-click in the **Control Panel** Window on the **PG/PC interface** icon.

The **Set the PG/PC Interface** dialog box is opened.

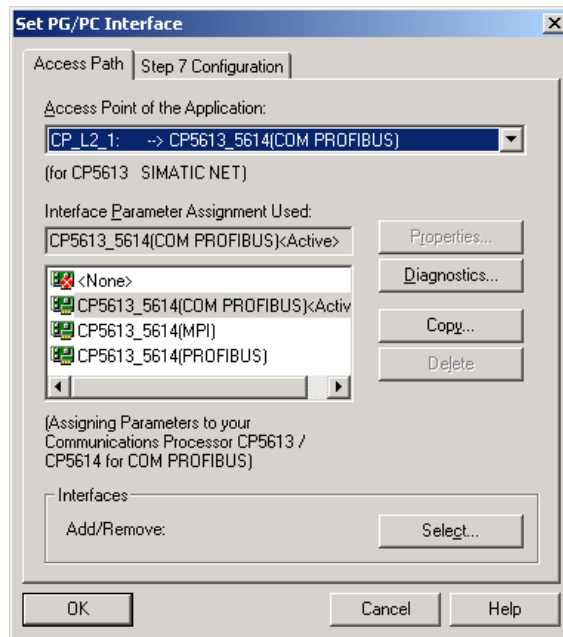

DIGSIKOM014b.gif

Fig. 7-25 Setting the PG/PC interface

- Select the **CP5613_CP5614(COM PROFIBUS)** entry in the **Interface Parameter Assignment Used** box as the active PROFIBUS FMS interface.
- Select the **CP_L2_1** as the **Access point of application**.

Properties

- Click the **Properties** command button

The **Properties - CP5613_5614(PROFIBUS)** dialog box is displayed.

- Change to the **FMS/DP Protocol** tab.

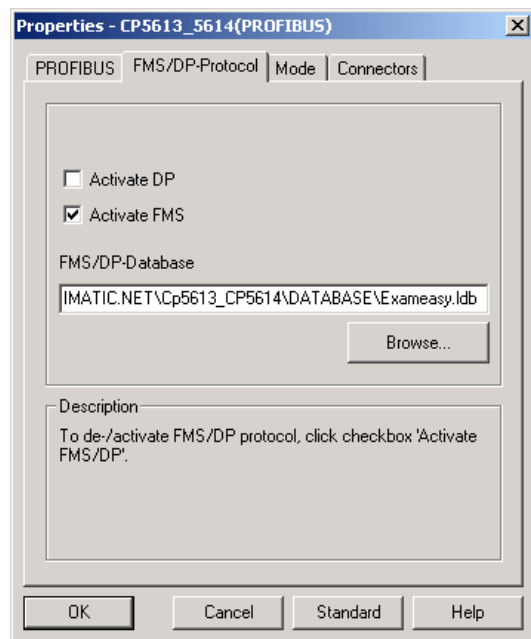

DIGSIKOM015a.gif

Fig. 7-26 Properties - CP5613_5614(PROFIBUS),
FMS/DP-Protocol tab

Activating FMS

- Activate the **Activate FMS** check box. The **Activate DP** check box must not be checked.
- In the **FMS/DP Database** input box enter the name of the NCM file including the complete path designation directly or search for the file by using the **Search** command button in the **Select Database** dialog box.

Resetting and Restarting

- Change to the **Mode** tab and click the **Restart** command button. This resets the CP and restarts it.

The course of the processes is displayed in the lower section of the dialog box.

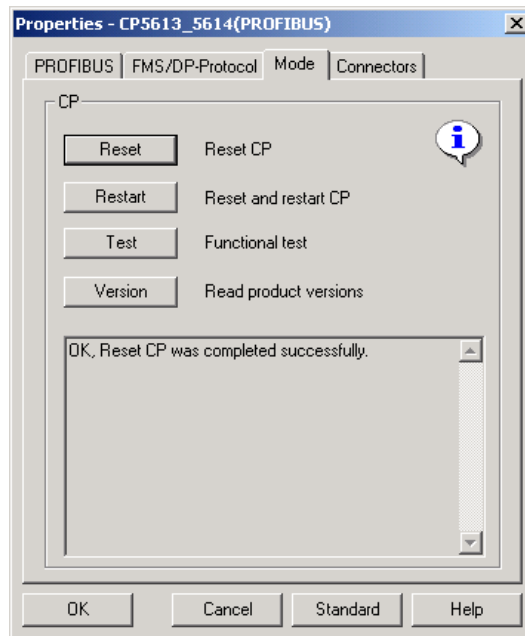

DIGSIKOM018a.gif

Fig. 7-27 Properties dialog box, Mode tab

- Click **OK**. Also click **OK** in the **Set the PG/PC interface** dialog box.

7.8.1.8 Preparing Operation without SICAM Control Center

Proceed as follows in order to set the communication parameters in the PROFIBUS FMS network in which you only communicate between DIGSI 4 and SIPROTEC 4 devices:

- Open your project in DIGSI 4.
- Select the **SIPROTEC 4 device** and open the **Object properties** via the context menu.
- Change to the **FMS / IEC setting** tab in the **Properties - SIPROTEC 4 device** dialog box.

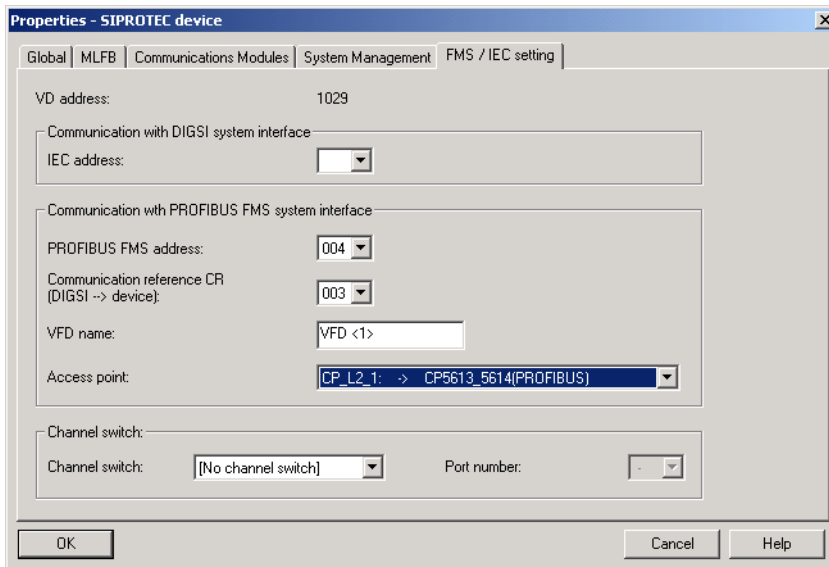

DIGSIKOM058a.gif

Fig. 7-28 Properties - SIPROTEC 4 device, FMS / IEC setting tab

- Select the **PROFIBUS FMS address** and **Communication reference CR** which you assigned when configuring the master system (see Chapter 7.8.1.4).

A VFD name for DIGSI 4 is automatically assigned in the **VFD name** box. Do not change this value.

The designation of the access point of the application corresponds to the designation defined during the setting of the PG/PC interface (see Chapter 7.8.1.7).

- Confirm by clicking **OK**.

7.8.1.9 Preparing Operation with SICAM Control Center

If a SIPROTEC device is to be operated in conjunction with a SICAM control center, a full version of STEP 7 must also be installed in addition to DIGSI 4. For a detailed description of the procedure please refer to the documentation of SICAM SAS and STEP 7.

Proceed as follows:

- Start the SIMATIC Manager and open your project.
- Use **View > Component view** to select the component view of the project.
- Select the **SIPROTEC 4 device** and open the **Properties - SIPROTEC 4 device** dialog box by means of the **Object properties** context menu. Change to the **PROFIBUS FMS Connections** tab.

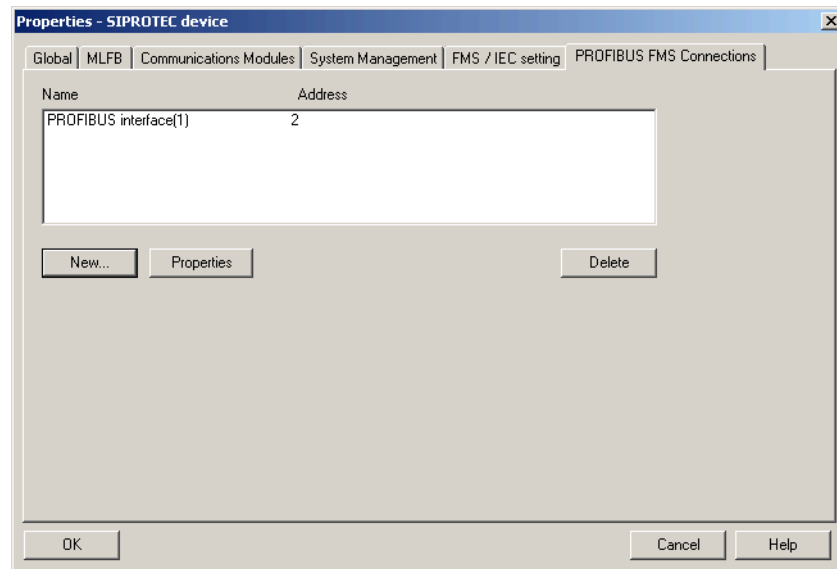

DIGSIKOM019a

Fig. 7-29 Properties - SIPROTEC 4 device, PROFIBUS FMS connections tab

Add Connection

- Click **New** and change to the **Parameters** tab in the **Properties - PROFIBUS interface** dialog box. The names and transmission rates of all the PROFIBUS FMS subnetworks available are displayed.

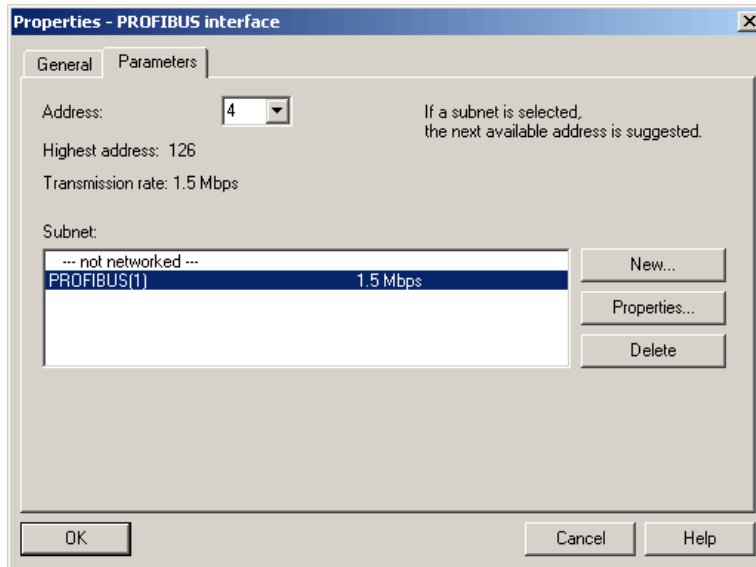
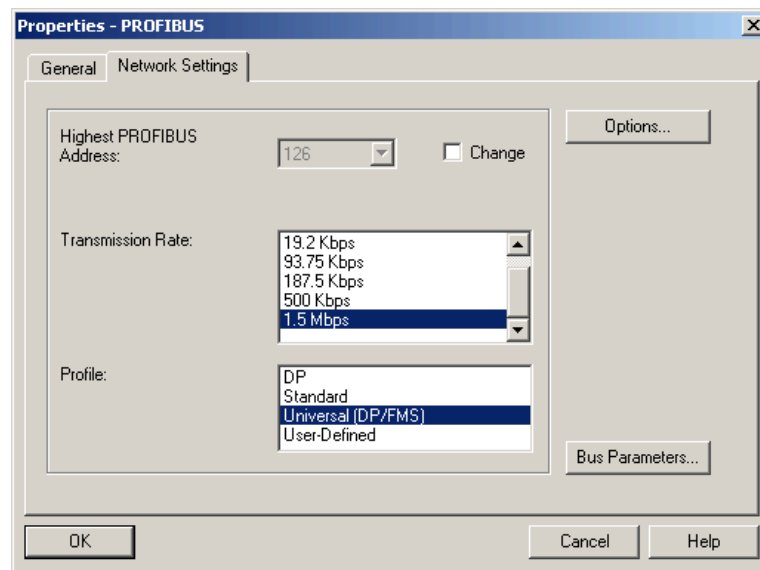

Fig. 7-30 Properties - PROFIBUS interface, Parameters tab

Selecting a Subnetwork

- Select the subnetwork that you want to add as an additional connection for the SIPROTEC 4 device.
- Check the network profile. To do so click on **Properties** and change in the **Properties - PROFIBUS** dialog box to the **Network Settings** tab, where **Universal (DP/FMS)** has to be selected in the **Profile** select box.



DIGSIKOM021a

Fig. 7-31 PROFIBUS Properties, Network Settings tab

- Click **OK**.
- Select the PROFIBUS FMS address which you specified when configuring the master system for the device in the **Address** field of the **Properties - PROFIBUS Node** dialog box.
- Confirm by clicking **OK**.
- Click **OK** in the **FMS / IEC setting** tab of the **Properties - SIPROTEC 4 device** dialog box in order to accept the displayed connections.

Inserting PG/PC

Now insert an object of the type **PG/PC** in your project in order to integrate DIGSI 4 in the project structure.

Proceed as follows:

- Select your project and click **Insert > Station > 7 PG/PC**.
- Assign the name **DIGSI PC** to the inserted object and open the **Properties - PG/PC** dialog box via the **Object Properties** context menu.
- Change to the **Interfaces** tab.

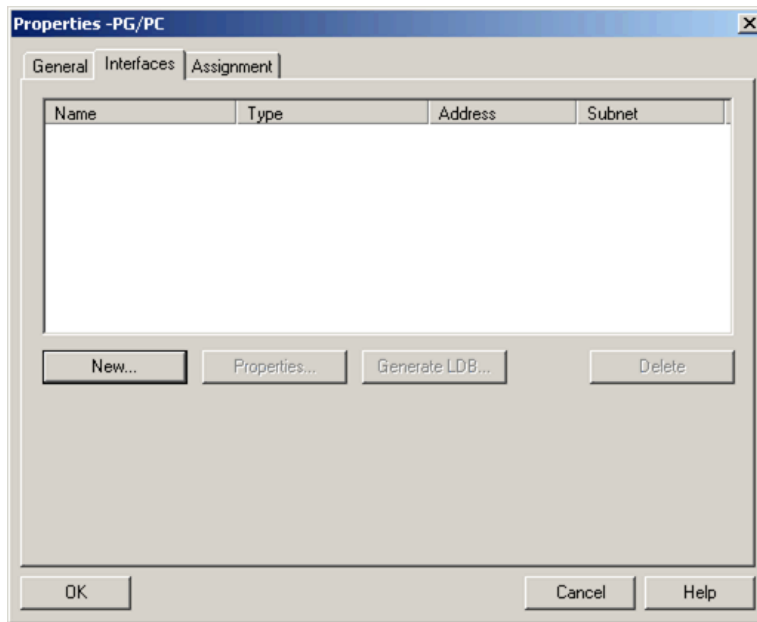

DIGSIKOM024a

Fig. 7-32 Properties - PG/PC, Interfaces tab

- Click **New**.

The **New Interface - Select Type** dialog box is opened.

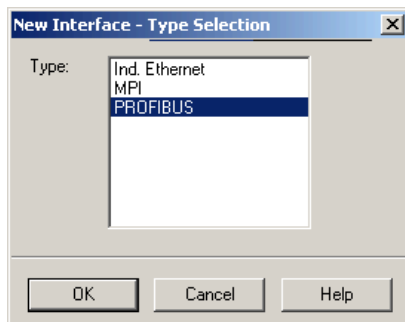

DIGSIKOM027a

Fig. 7-33 New Interface - Select Type

- Select the **PROFIBUS** setting in the select box and click **OK**.

The **Properties - PROFIBUS Node** dialog box is opened.

- Click the **Settings** tab. This tab shows the names and transmission rates of all available PROFIBUS FMS sub-networks.
- Select the subnetwork via which your DIGSI 4 PC is to be connected.
- Check the profile via the **Network Settings** tab in the **Properties - PROFIBUS** dialog box. The **Universal DP/FMS** setting has to be selected.
- Click **OK**.
- Select the PROFIBUS FMS address which you specified when configuring the master system for the device in the **Address** field of the **Properties - PROFIBUS Node** dialog box.
- Confirm by clicking **OK**.

- Click **OK** in the **FMS / IEC setting** tab of the **Properties - SIPROTEC 4 device** dialog box in order to accept the displayed connections.
- Change to the **Assignment** tab in the **Properties - PG/PC** dialog box.

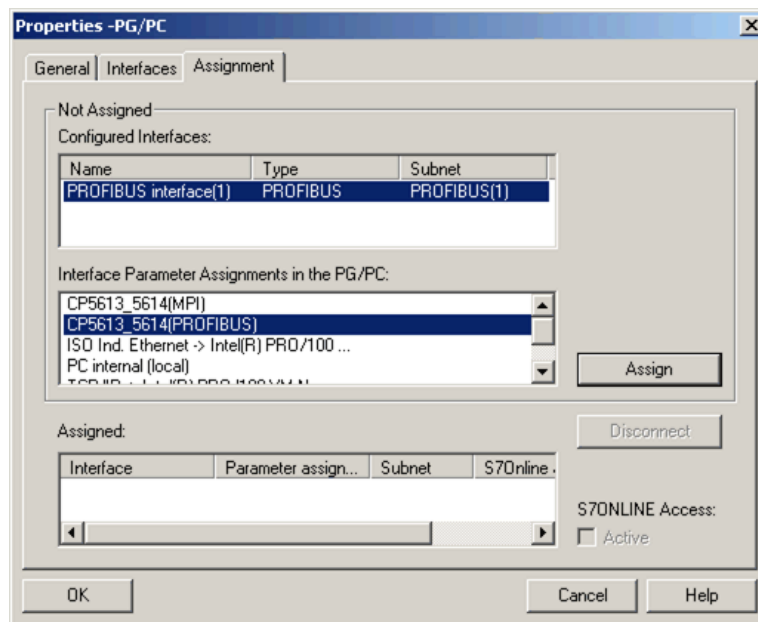

DIGSIKOM026a

Fig. 7-34 Properties - PG/PC, Assignment

- Select the **PROFIBUS interface(1)** entry in the **Configured Interfaces** select box and the **CP5613_5614(PROFIBUS)** entry in the **Interface Parameter Assignments in the PG/PC** select box.
- Click **Assign** and **OK**.

Displaying the Network Configuration

Display the current network configuration in order to check it.

- Double-click the **PROFIBUS** object.

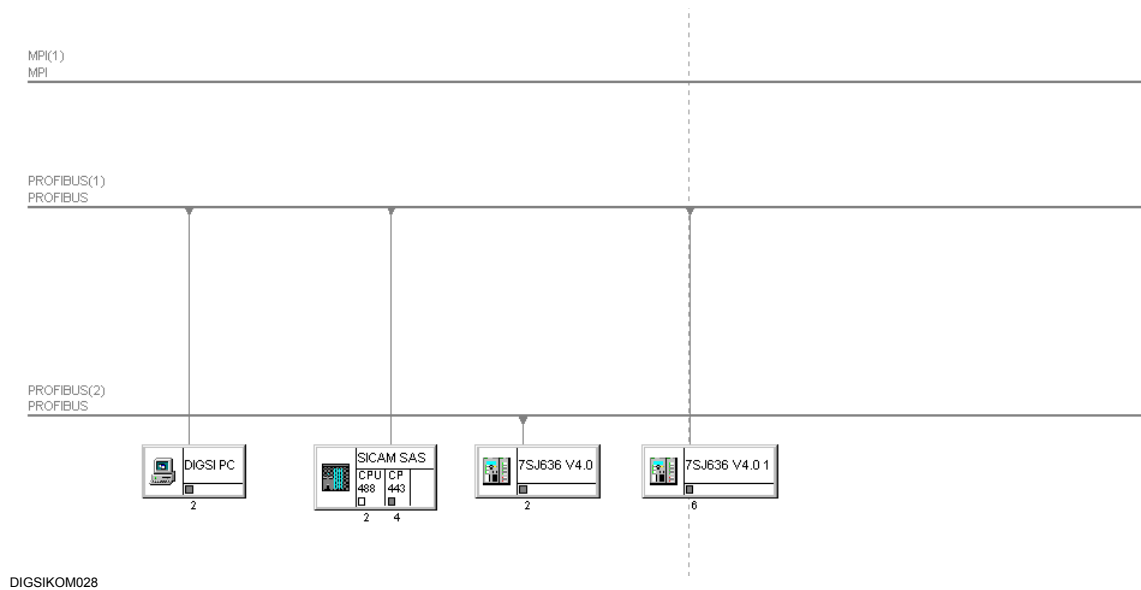

DIGSIKOM028

Fig. 7-35 Example of the network configuration with SICAM Station and DIGSI PC

Updating the Master System

- Extend the master system by a SICAM station. To do so, start the **COM PROFIBUS** program and load the file (.PB5) in which you have saved the data of your master system.
- Click with the left mouse button on the icon for the **CP 5613** component. The **FMS Station Parameters** dialog box is opened.
- Select **Object properties...** via the context menu.

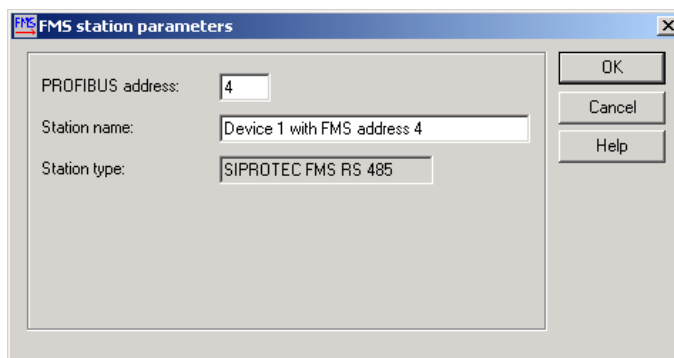

DIGSIKOM001b.gif

Fig. 7-36 FMS Station parameter

- Enter a PROFIBUS FMS address and click **OK**.

Saving and Exporting a Master System

- Save the master system under the same name and location as the original file and export it as an NCM database.

7.8.1.10 Checking or Changing Variable Addresses and Lengths

The variables **Variable 1** and **Variable 2** which contain the information are required to exchange data via a PROFIBUS FMS network. The **Master Ready** variable which has a predefined value is used as soon as the PROFIBUS FMS interface for data exchange is ready.

Proceed as follows in order to check these variables:

- Open your device and double-click in the function view on **Interfaces**.
- Change in the **Interface Settings** dialog box the **PROFIBUS FMS on the PC** tab.

	Write index	Read index	Length
Variable 1:	100	101	44
Variable 2:	102	103	232
Master ready:	104		

DIGSIKOM064a

Fig. 7-37 Interface Settings, PROFIBUS FMC on the PC tab



NOTE

You should normally not change the variables. The specifications for the **Length** must agree with the specifications for the device.

- ❑ The values in the **Write index** box are addresses for write access to the variables **Variable 1**, **Variable 2** and **Master ready**.
- ❑ The values in the **Read index** box are addresses for read access to the variables **Variable 1** and **Variable 2**.
- ❑ The values in the **Length** box specify the length of the variables **Variable 1** and **Variable 2**. They must agree with the corresponding values in the **PROFIBUS FMS on the device** tab.

Parameters for the Device Interface

- Change to the **PROFIBUS FMS on the device** tab.

The screenshot shows the 'Interface Settings' dialog box with the following fields and values:

Field	Value
Module number:	1
Module ID:	1
PROFIBUS FMS address:	4
Type:	1
Length variable 1:	44
Length variable 2:	232
Control value:	0

Access authorization at interface for:

- Customize
- Test and diagnostic

Buttons: OK, DIGSI -> Device, Cancel, Help

DIGSIKOM061

Fig. 7-38 Interface Settings, PROFIBUS FMC on the device tab

- ❑ The values in the **Length variable 1** box specifies the length of the **Variable 1** variable. It must agree with the corresponding value in the **PROFIBUS FMS on the PC** tab.
- ❑ The values in the **Length variable 2** box specifies the length of the **Variable 2** variable. It must agree with the corresponding value in the **PROFIBUS FMS on the PC** tab.

**NOTE**

You should normally not change the variables.

7.8.1.11 Establishing a Connection via PROFIBUS FMS

Proceed as follows in order to establish a connection via PROFIBUS FMS:

- In the DIGSI 4 project view select a **SIPROTEC 4 device** or a **SIPROTEC 4 variant** and click on **Device > Open** in the context menu.
- Select the option Online via **PROFIBUS FMS** and click **OK**.

7.8.1.12 Closing a Connection via PROFIBUS FMS

Existing PROFIBUS FMS connections can be closed manually or time-controlled.

Close a SIPROTEC 4 Device

- Select **File > Close** in order to close the SIPROTEC device. The connection via PROFIBUS FMS is closed automatically.
- Respond to the confirmation box.

If several device windows are open, the operations described refer to the active device window.

Terminating Device Editing

- Quit the Device Editor in DIGSI 4 by means of **File > Exit**. All the devices are closed and any existing connection via PROFIBUS FMS is closed automatically. Respond to the confirmation boxes of the individual devices.

7.8.2 PROFIBUS FMS V6.1 with SIMATIC NET Software 11/2002 + SP1



NOTE

Configurations which were created with an earlier program version of SIMATIC NET are NOT compatible.

Operations

Proceed as follows in order to establish and configure communication between the PC and device via a PROFIBUS FMS:

- Install the hardware.
- Install the software (SIMATIC NET software **11/2002** or **07/2001**, STEP 7 (full version), DIGSI)



NOTE

On the installation CD, you will find the following versions

- V6.1 CD 11/2002 + SP1 (for Windows XP and Windows 2000)
 - V6.0 CD 07/2001 + SP5 + HF2 (not to be used for DIGSI 4.50).
-

- Configure the PC station.
- Create a project.
- Insert SIPROTEC devices.
- Configure the PROFIBUS network.
- Load the configuration data to the CP5613.
- Establish a connection via PROFIBUS FMS.
- Close the connection via PROFIBUS FMS.
- Diagnosis options for problems with the connection establishment

7.8.2.1 Installing Hardware

In order to implement communication via PROFIBUS FMS the **CP 5613** communications processor interface card is required. For information on installing the card as well as on the physical connection to the PROFIBUS FMS network please refer to the documentation on the **CP 5613** communications processor.

7.8.2.2 Installing SIMATIC NET V6.1, STEP 7 (full version) and DIGSI

Install the software components. Please refer to the installation information in the documentation of the respective software package and Chapter 7.8.1.2.

Observe the following notes:



NOTE

- ❑ For STEP 7, you must install the NCM components for PROFIBUS as well.
- ❑ For **SIMATIC NET V6.1**, you may only install the **SIMATIC NET PC software**.
- ❑ DIGSI can be installed before SIMATIC NET V6.1.



NOTE

For SICAM customers: Simultaneous use of DIGSI and Recpro on **a single PC** is possible, but you have to parameterize the DIGSI connection manually.

7.8.2.3 Configuring the PC Station

To configure the PC station, proceed as follows:

- Select **SIMATIC NET > Settings > Set PC Station**. The **Configuration Console** is started.
- Select in the **Tree** tab the **CP5613/CP5614** module, and then select **General**.

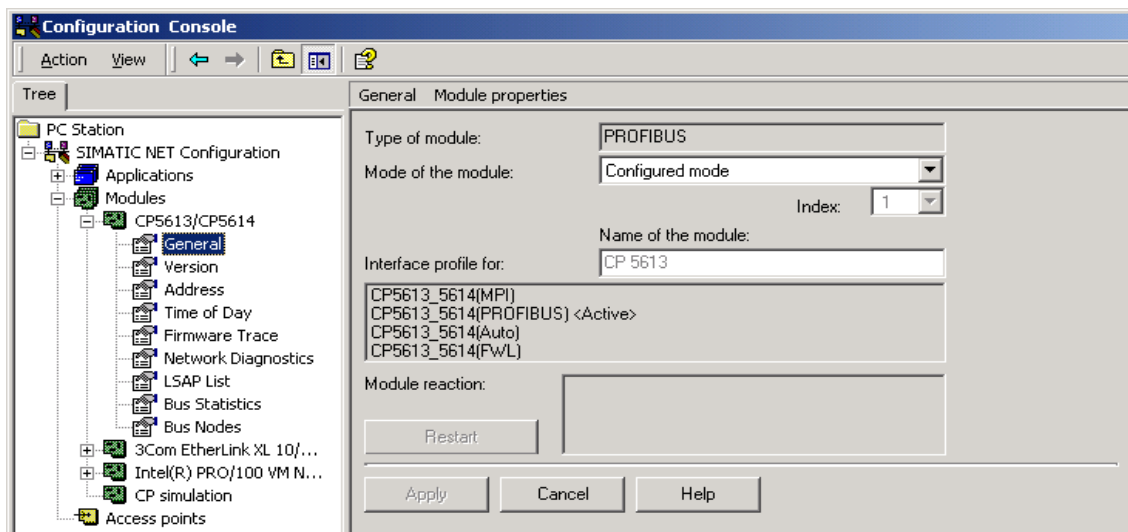
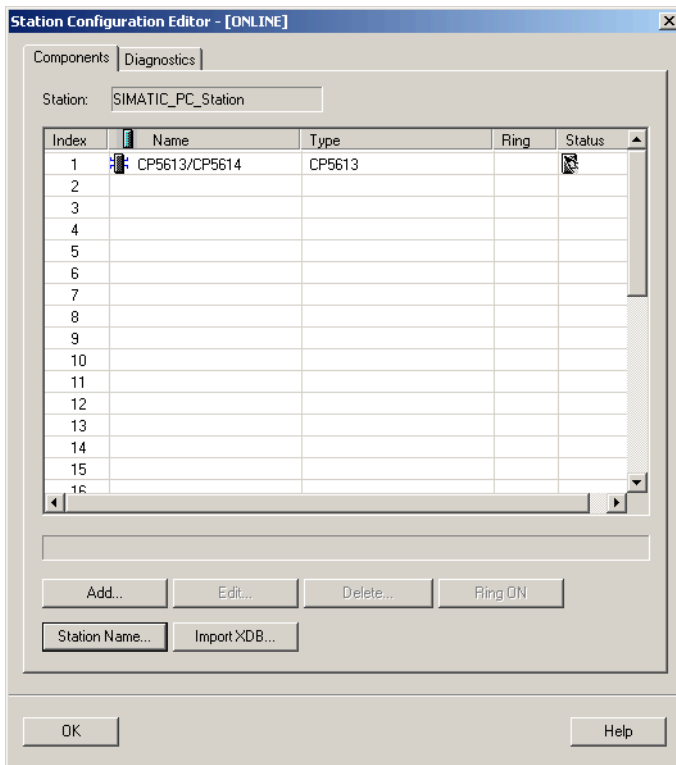

Fig. 7-39 Configuration Console "Set PC Station"

- Select the **Configured Mode** entry under **Mode of the module**.
- Click **Apply**.

- Start the **Station Configuration Editor**. The CP5613 communications processor is already entered.



DIGSIKOM139.gif

Fig. 7-40 Station Configuration Editor

- Click **Station Name...** to issue a name to the station:

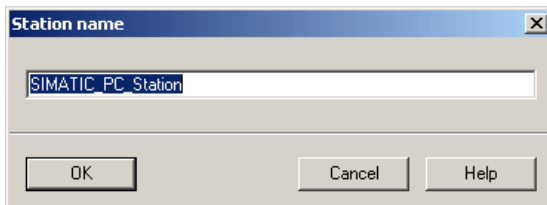

DIGSIKOM140.gif

Fig. 7-41 Issuing a station name

- Click **OK** to save the name.

- Click **Add...** in the **Station Configuration Editor** to configure **DIGSI** as an application.

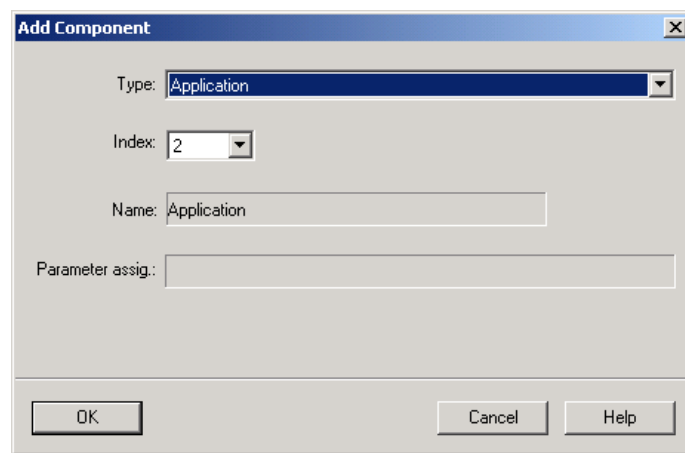

Fig. 7-42 Adding a component

- Click **OK** and then exit the **Station Configuration Editor** with **OK** as well.

7.8.2.4 Creating a Project

To create a project in **SIMATIC Manager**, proceed as follows:

- Start the SIMATIC Manager.
- Select the menu item **File > New** and enter a name for the new project.

Inserting a PC Station

- Select the menu item **Insert > Station > SIMATIC PC Station** to insert a PC station in the project.
- Select **Object properties** from the context menu and enter the same name for the PC station as in the **Station Configuration Editor**.

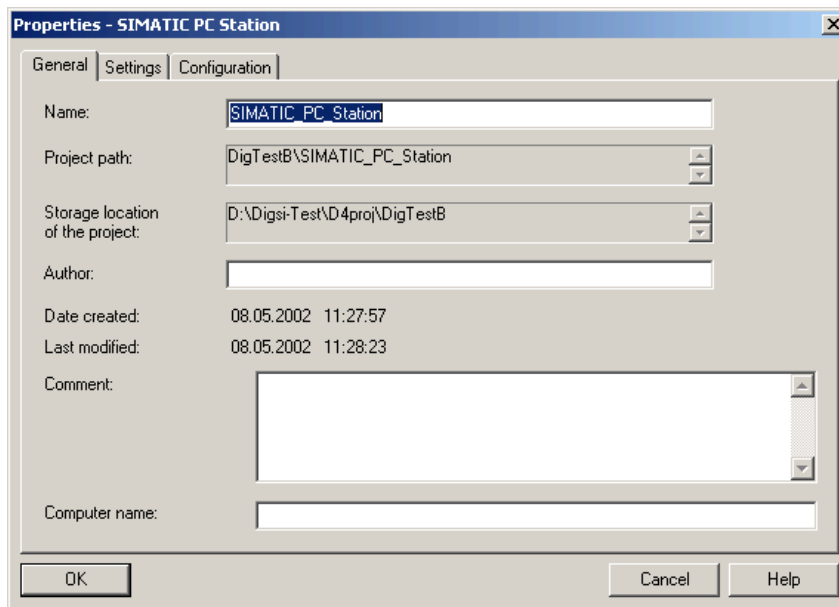

DIGSIKOM142.gif

Fig. 7-43 Properties - SIMATIC PC Station

- Close the **Properties - SIMATIC PC Station** dialog box with **OK**.
- Open the PC station by double-clicking the object.
- Open the **Configuration** entry by double-clicking the object.

Adding a Communications Processor

- Add the CP card via Drag & Drop from the **Hardware Catalog** of the PC station.

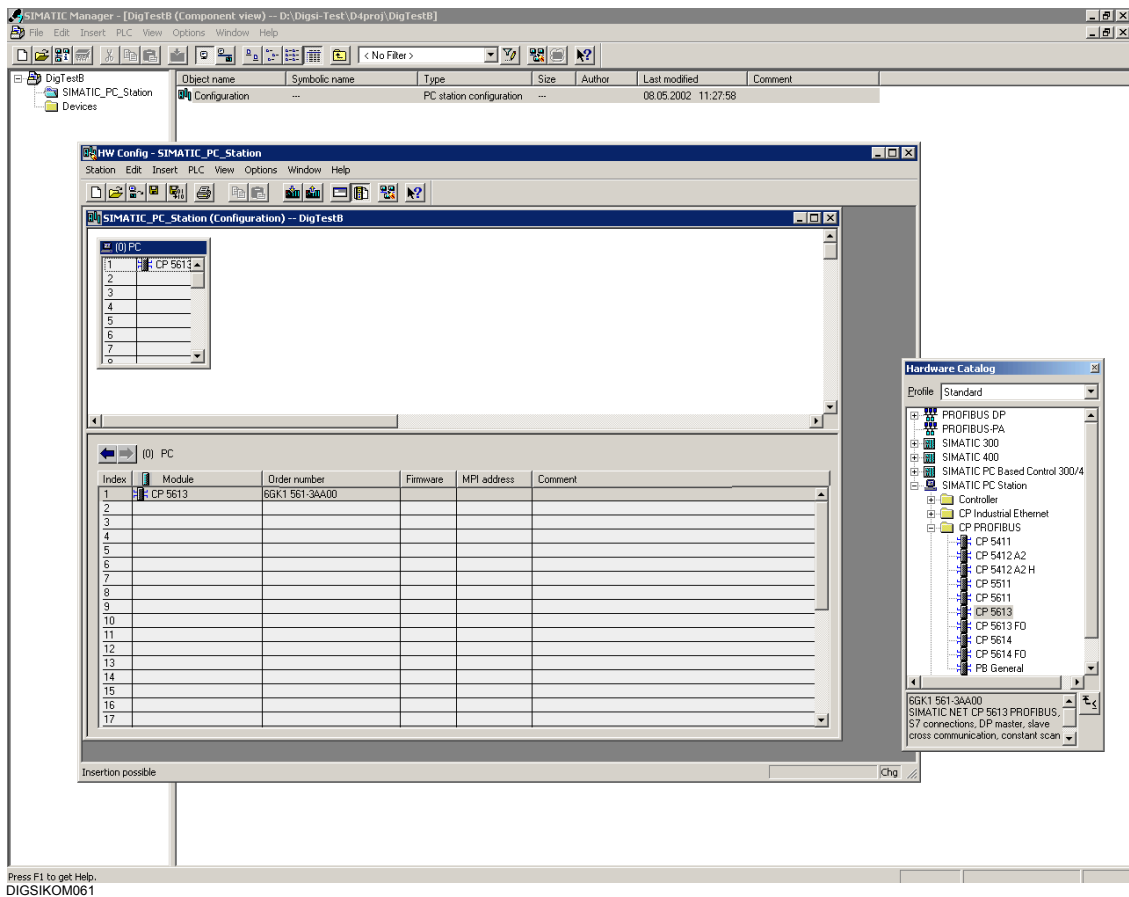
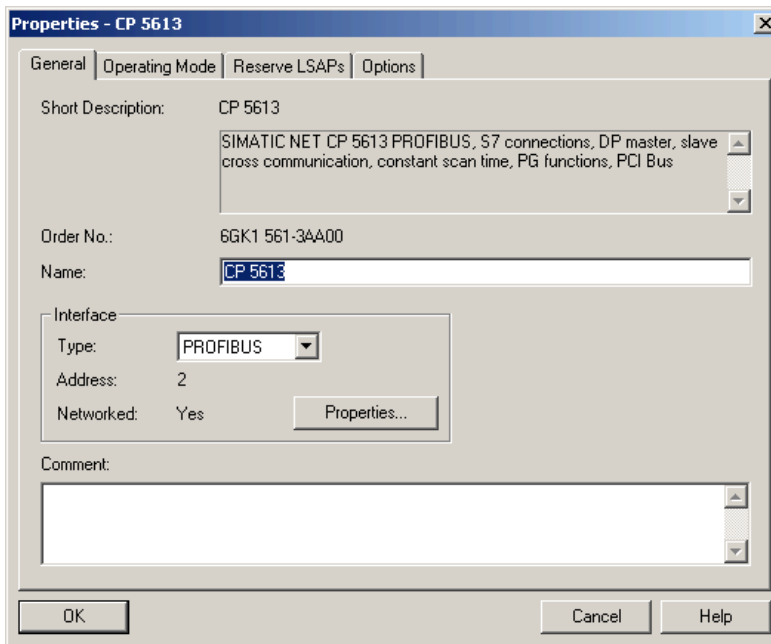

Fig. 7-44 SIMATIC Manager, HW Config - SIMATIC_PC_Station

- Select **Object properties** from the context menu of the CP5613 and set the interface type **PROFIBUS** in the **General** tab.



DIGSIKOM144.gif

Fig. 7-45 Properties - CP 5613

- Click **Properties**.
- Set the subnet and the address of the module in the **Properties - PROFIBUS interface CP5613** dialog box.

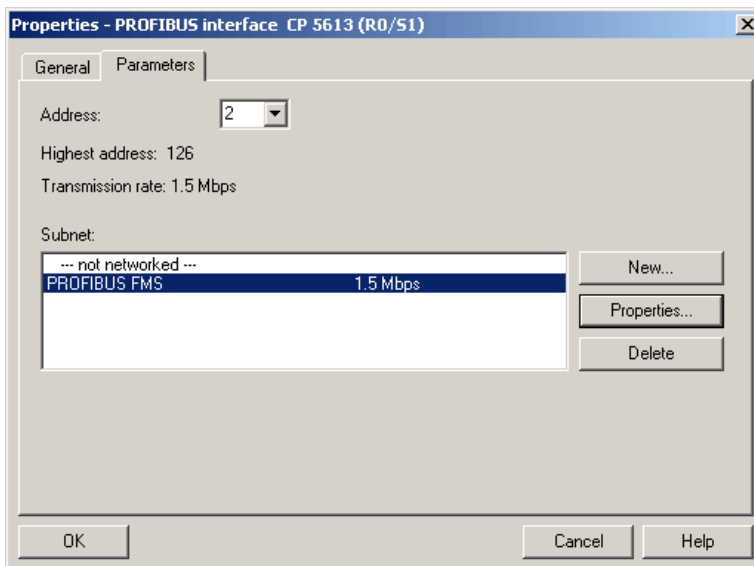

DIGSIKOM145.gif

Fig. 7-46 Properties - PROFIBUS interface CP5613

- Click **Properties**.
- Set the transmission rate and profile in the **Properties - PROFIBUS** dialog box, on the **Network Settings** tab.

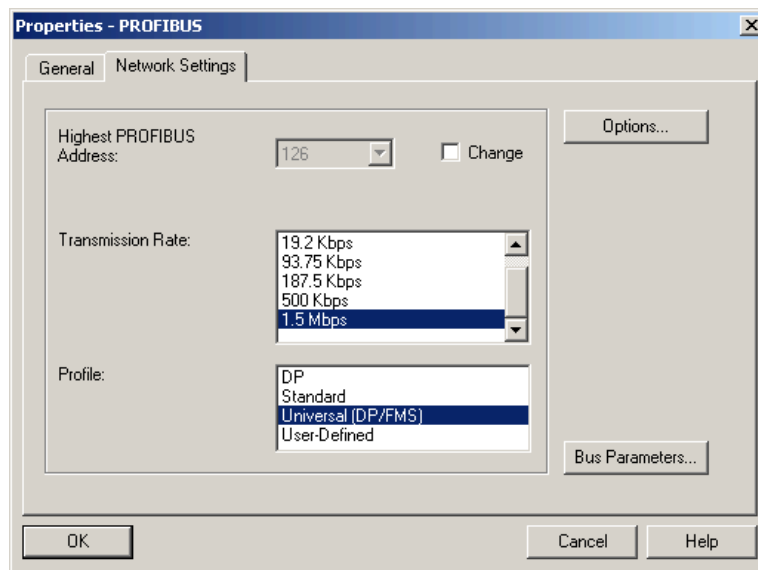

DIGSIKOM146.gif

Fig. 7-47 Properties - PROFIBUS, Network Settings tab

- Close the **Properties - PROFIBUS** dialog box with **OK**.
- Close the **Properties - PROFIBUS interface CP5613** dialog box with **OK**.
- Change to the **Operating Mode** tab in the **Properties - CP5613** dialog box.

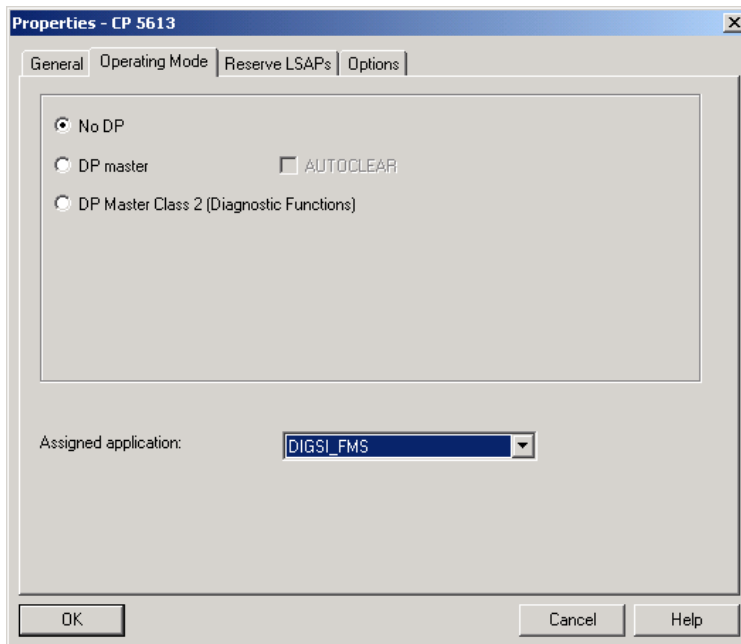

DIGSIKOM147.tif

Fig. 7-48 Properties - CP5613, Operating Mode tab

- Change to the **Options** tab in the **Properties - CP5613** dialog box.

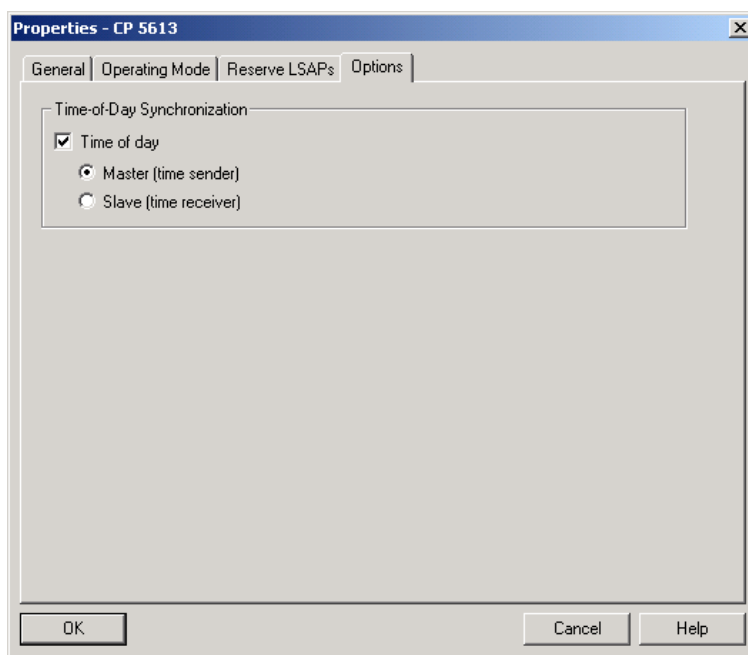

DIGSIKOM147_2.tif

Fig. 7-49 Properties - CP5613, Options tab

- Select the **Time-of-Day Synchronization, Master** option, if you want to use the PC time to synchronize the devices connected to the PROFIBUS net. Click **OK** to close the dialog.

Adding an Application

- Add a user application via Drag & Drop from the **Hardware Catalog** of the PC station.

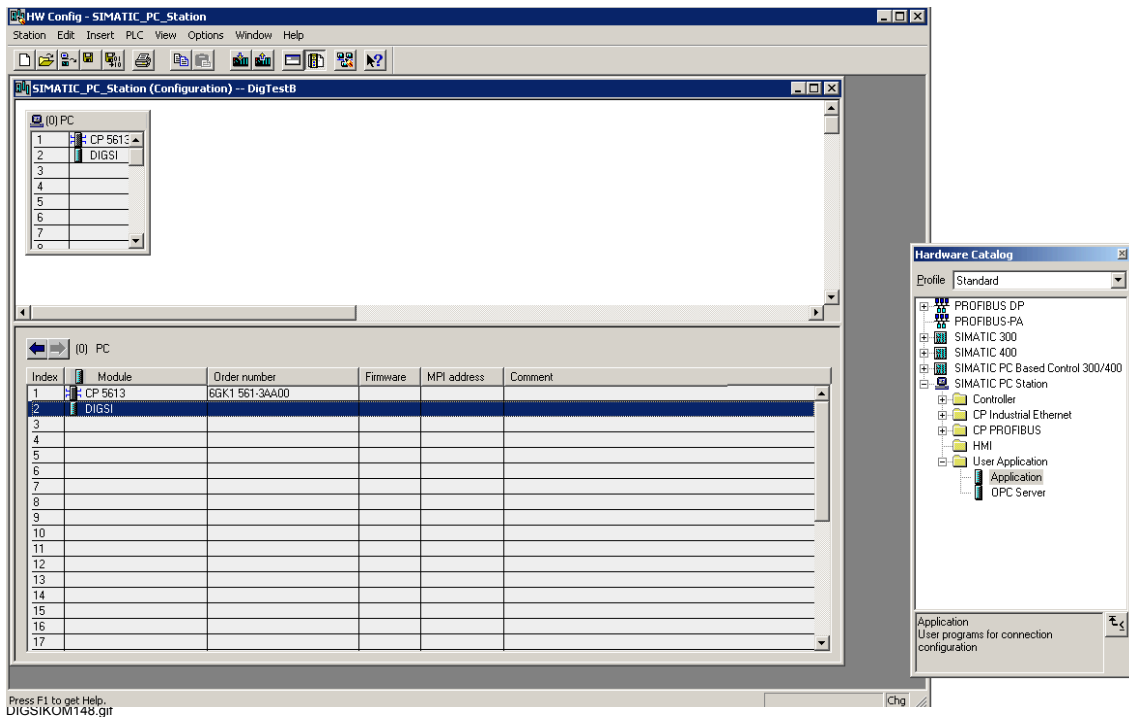

Fig. 7-50 SIMATIC Manager, HW Config - SIMATIC_PC_Station: Adding a user application



NOTE

The name of the application must be identical to the one which you issued in the Station Configuration Editor. The names will be the same when you perform an XDB import.



NOTE

Assign this name to the CP5613 in the dialog **Object properties > Operating Mode**.

- Select **Object properties** from the context menu of the application and click **Edit VFDs** in the **FMS** tab.
- Click **New** to set up a new VFD (Virtual Field Device).

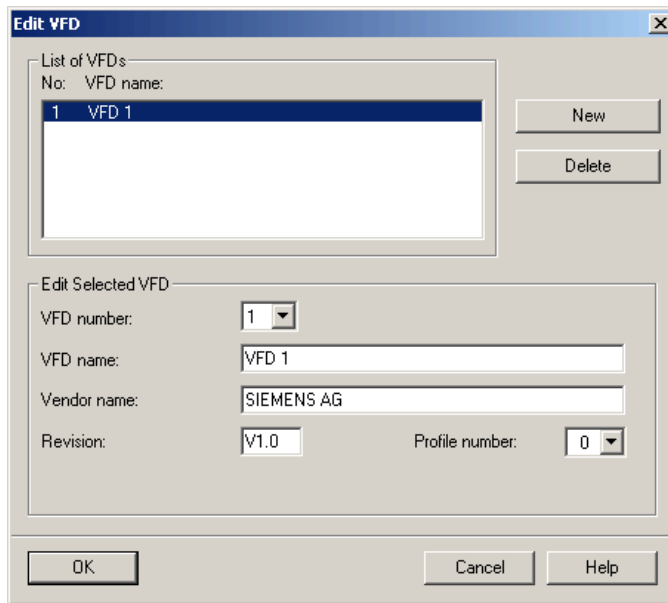

DIGSIKOM149.gif

Fig. 7-51 Edit VFD

**NOTE**

From DIGSI 4.5 the VFD address is assigned via **Options > Configure DIGSI 4, PROFIBUS FMS** tab (see Figure 7-52). The name applies globally and must be identical with the name assigned in the **Edit VFD** dialog box (Figure 7-51).

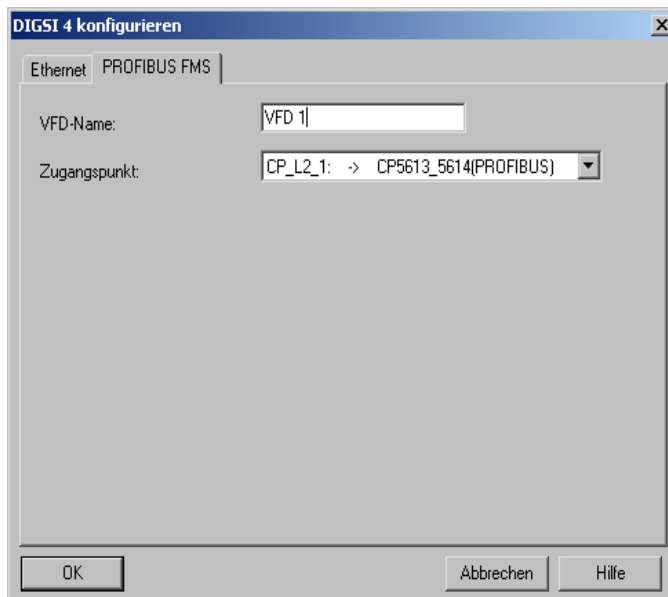

DIGSIKOM149_2.tif

Fig. 7-52 Configuring DIGSI 4

- Close the **Edit VFD** dialog box by clicking **OK**.
- Close the object properties by clicking **OK**.
- Select the menu item **Station > Save and Convert** to save your changes.
- Close the hardware configuration.

Making Sure that the Application Name is Identical

- Select the **Configuration** tab in **Object properties** of the PC station.

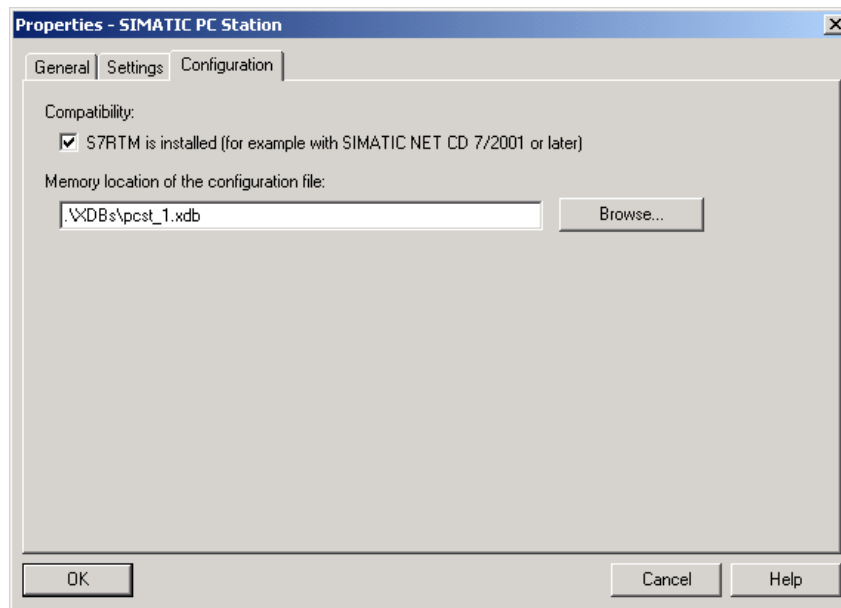

DIGSIKOM149_3.tif

Fig. 7-53 Properties - SIMATIC PC Station, Configuration tab

- Save your configuration file in the **XDBs** directory of your project by clicking **OK**.
- Open the PC station in the **Station Configuration Editor** (see Figure 7-40) and click **Import XDB** to adjust the settings.



NOTE

Importing an XDB file changes the operating mode of the Station Configuration Editor to **OFFLINE**.

7.8.2.5 Inserting SIPROTEC Devices

To insert your SIPROTEC devices, proceed as follows:

- Select the menu item **Insert New Object > SIPROTEC Device** and insert the desired device into your project via Drag & Drop from the device catalog.
- Select **Object properties** from the context menu of the device and click **New** in the **PROFIBUS FMS** tab.
- Select a subnet in the **Properties - PROFIBUS interface** dialog box. The next available address on this network is entered in the Address field.

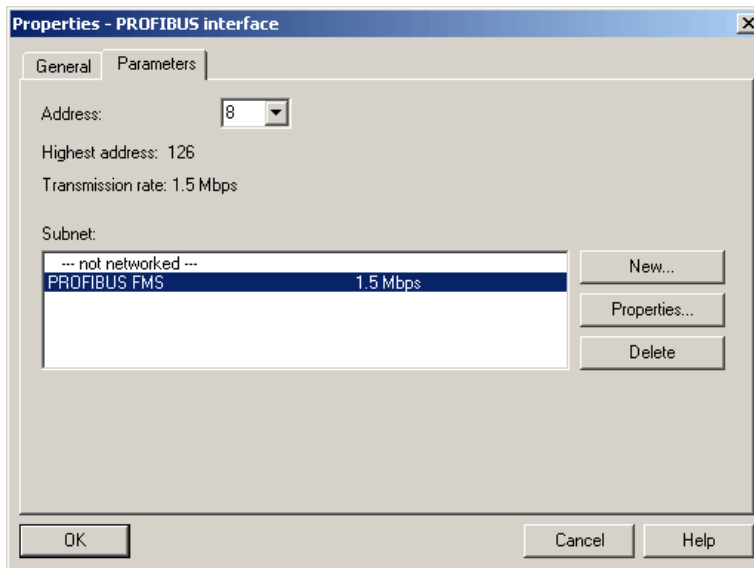

DIGSIKOM150.gif

Fig. 7-54 Properties - PROFIBUS interface

- Close the **Properties - PROFIBUS interface** dialog box with **OK**.

- Select the **FMS / IEC setting** tab in **Properties** and set the communication reference.

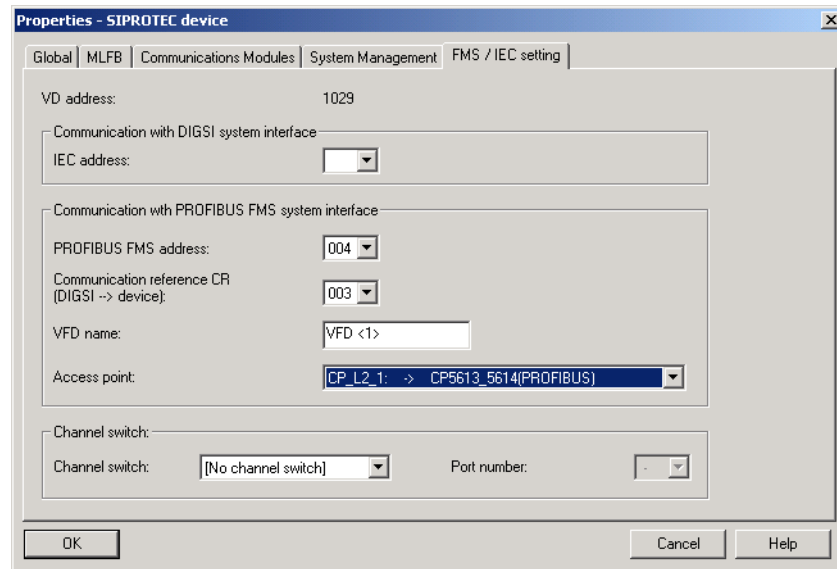

DIGSIKOM058a.gif

Fig. 7-55 Properties - SIPROTEC 4 device, FMS / IEC setting tab

7.8.2.6 Configuring PROFIBUS Network

To configure your PROFIBUS network, proceed as follows:

- Select the menu item **Options > Configure Network**. The NetPro application is started. It contains the configured PC station and the SIPROTEC devices.

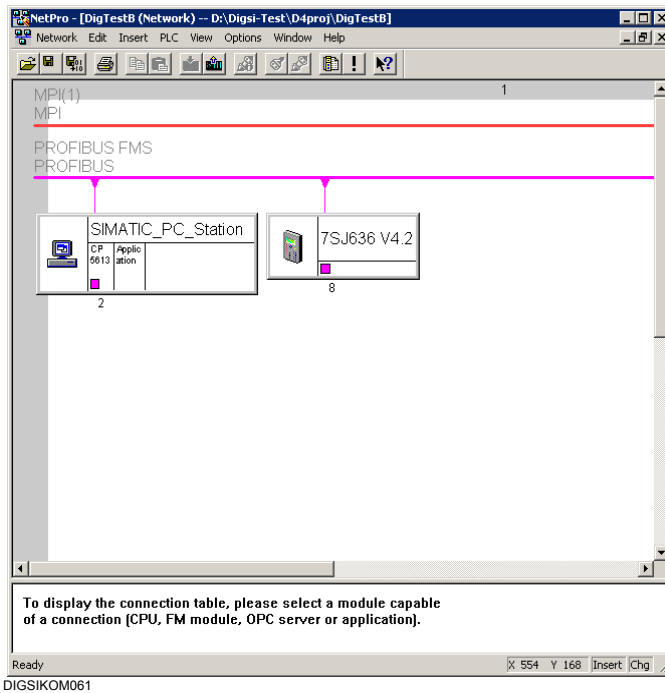
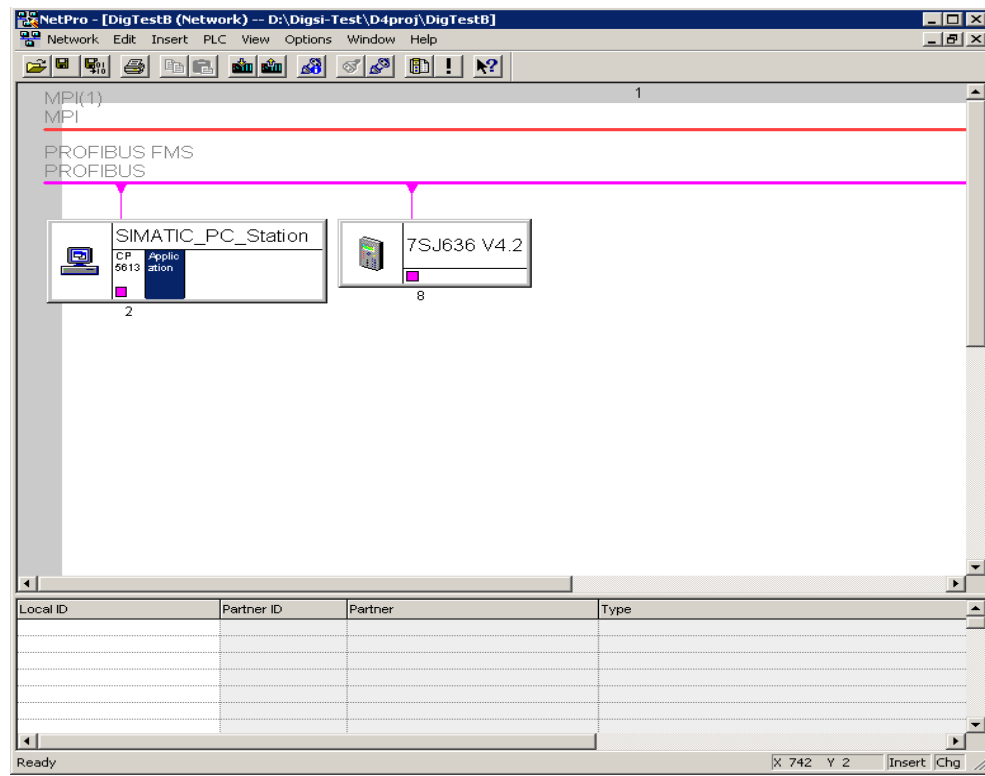

Fig. 7-56 NetPro with configured components

- Click **Application** in the **SIMATIC_PC_STATION**. A table for configuring the SIPROTEC devices is inserted.



DIGSIKOM152.gif

Fig. 7-57 NetPro with a table for configuring the SIPROTEC devices

- Right-click the first empty field in the **Local ID** column and select **Insert new connection**. The **Insert New Connection** dialog box appears.

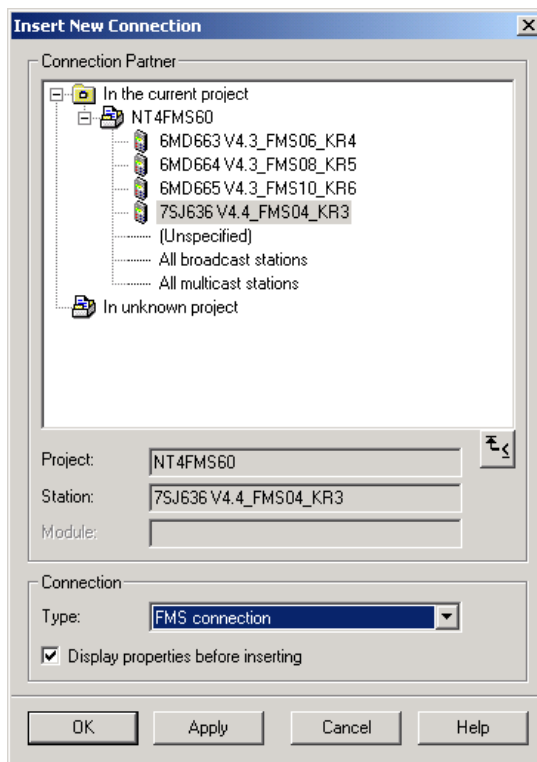

DIGSIKOM153.tif

Fig. 7-58 Inserting a new connection

- Select the SIPROTEC device under **Connection Partner**, select the entry **FMS connection** under **Connection** and activate the option **Display properties dialog**.
- Click **Apply**. The **Properties - FMS Connection** dialog box appears.

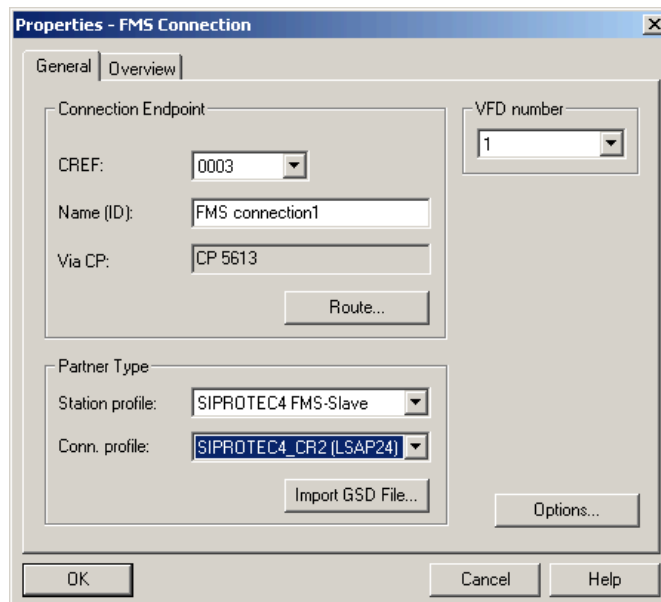

DIGSIKOM154.gif

Fig. 7-59 Properties - FMS connection

- Record the value of the CREF number and set the value **SIPROTEC4_CR2 (LSAP24)** under **Conn. profile**.
- Click **OK**.
- Repeat this procedure for all SIPROTEC devices which are connected to the PROFIBUS network.



NOTE

For a new project, the communication reference (CREF) always starts with "3". This number must be identical to the number assigned to the SIPROTEC device (see **Object properties** of the SIPROTEC device in the **Communication parameter** tab). The communication reference is unique for each device.

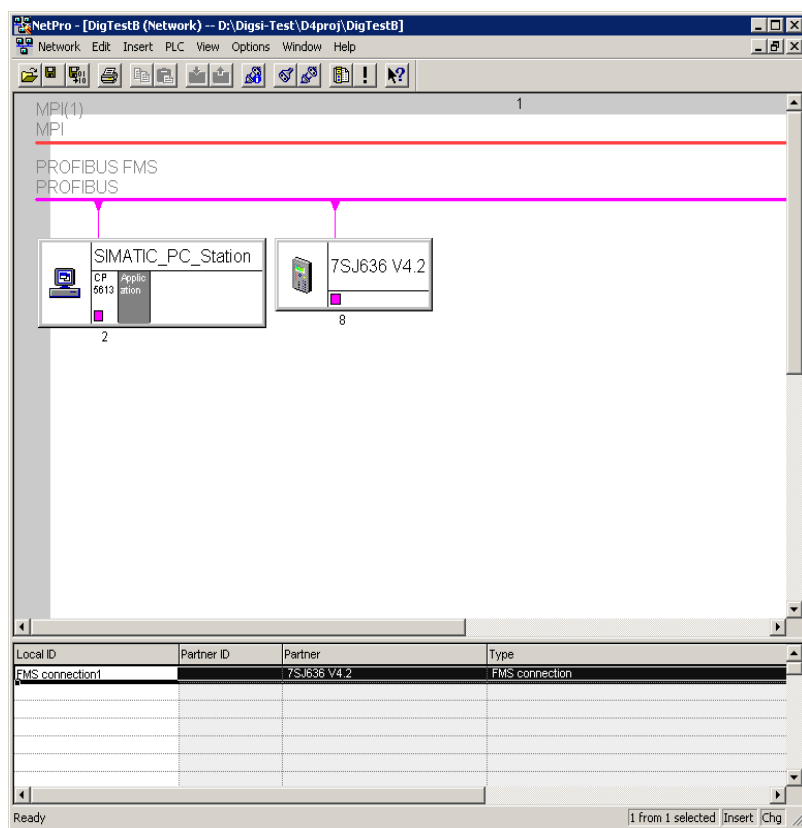

DIGSIKOM155.gif

Fig. 7-60 NetPro with configured SIPROTEC devices

- Select the menu item **Network > Save and Convert** to save your changes.
- Select **Convert and check everything** in the next dialog box and click **OK**.

7.8.2.7 Loading Configuration Data

To load the configuration data to the PLC CP5613, proceed as follows:



NOTE

This actions requires the operating mode ONLINE.

- Start the **Station Configuration Editor**.
- Click the button **Change Operating Mode** (only available in the **OFFLINE** operating mode) and answer the following query with **Yes**. The operating mode changes to **ONLINE**.

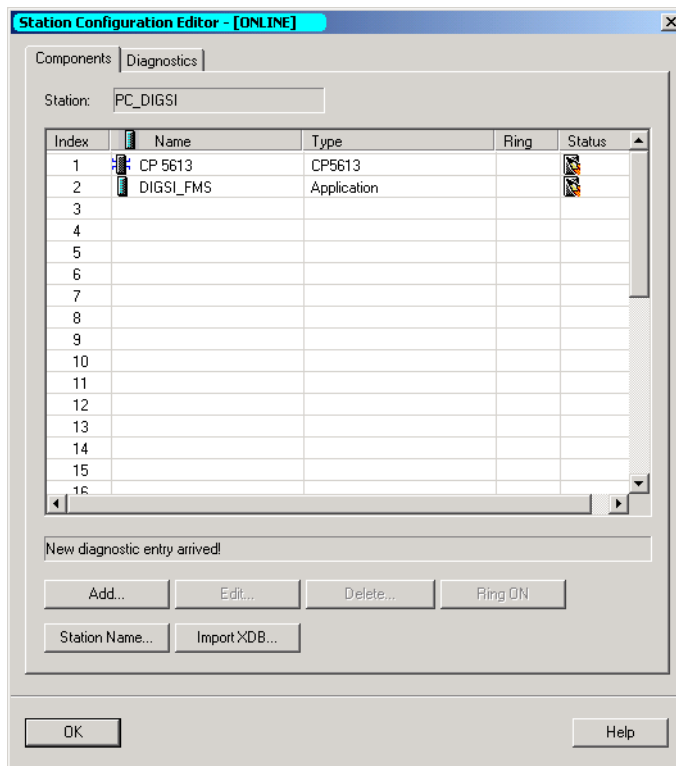

DIGSIKOM155_2.tif

Fig. 7-61 Station Configuration Editor - Operating mode ONLINE

- Change to the **NetPro** application.
- Click on the icon of the SIMATIC PC station.
- Select the menu item **PLC > Download to current project > Selected stations**.

- Answer the following query with **Yes** if you want to download the new data to your communications processor.

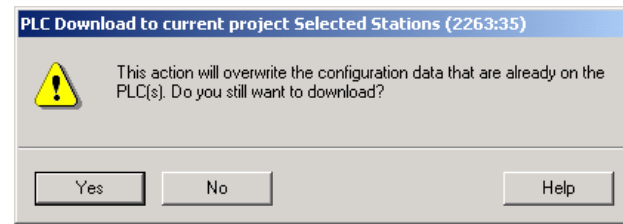

DIGSIKOM156.tif

Fig. 7-62 Confirmation query which appears when loading the configuration data

- Close the **NetPro** application.

7.8.2.8 Check Settings

You should check the following values once again to make sure that they are set properly:

- Object properties of the devices
 - CREF number
 - VD name
 - Access point
- Set the PG/PC interface (see Chapter 7.8.1.7)
 - Access point of the application
 - Interface parameterizing used

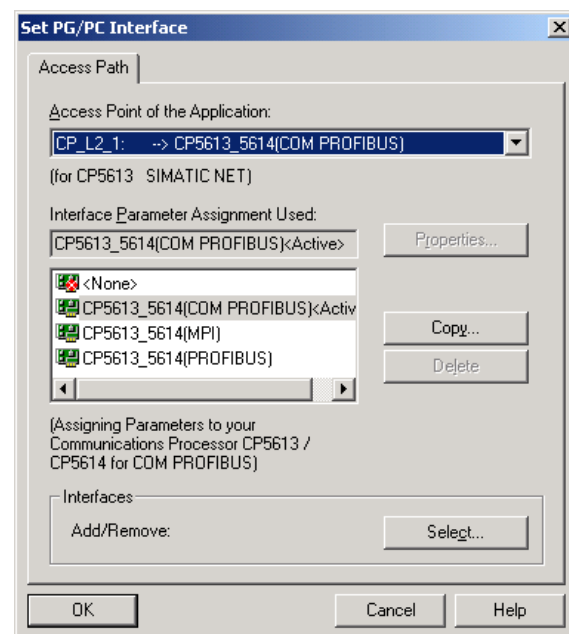

DIGSIKOM157.gif

Fig. 7-63 Properties - FMS connection

7.8.2.9 Establishing a Connection via PROFIBUS FMS

Proceed as follows in order to establish a connection via PROFIBUS FMS:

- In the DIGSI 4 project view select a **SIPROTEC 4 device** or a **SIPROTEC 4 variant** and click on **Device > Open** in the context menu.
- Select the option **Online via PROFIBUS FMS** and click **OK**.

7.8.2.10 Closing a Connection via PROFIBUS FMS

Existing PROFIBUS FMS connections can be closed manually or time-controlled.

Closing a SIPROTEC 4 Device

- Select **File > Close** in order to close the SIPROTEC device. The connection via PROFIBUS FMS is closed automatically.
- Respond to the confirmation box.

If several device windows are open, the operations described refer to the active device window.

Terminating Device Editing

- Quit the Device Editor in DIGSI 4 by means of **File > Exit**. All the devices are closed and any existing connection via PROFIBUS FMS is closed automatically. Respond to the confirmation boxes of the individual devices.

7.8.2.11 Diagnosis Options

Check the following points if problems occur with establishing the connection:

Bus Connector

The connector attached to the CP5613 must be actively terminated, just like the connector of the last device on the bus.

Configuration Console

Information on the possible error sources is available in the Configuration Console:

- Bus Statistics
Here you can see whether your CP5613 is connected to the ring and whether certain errors have occurred.

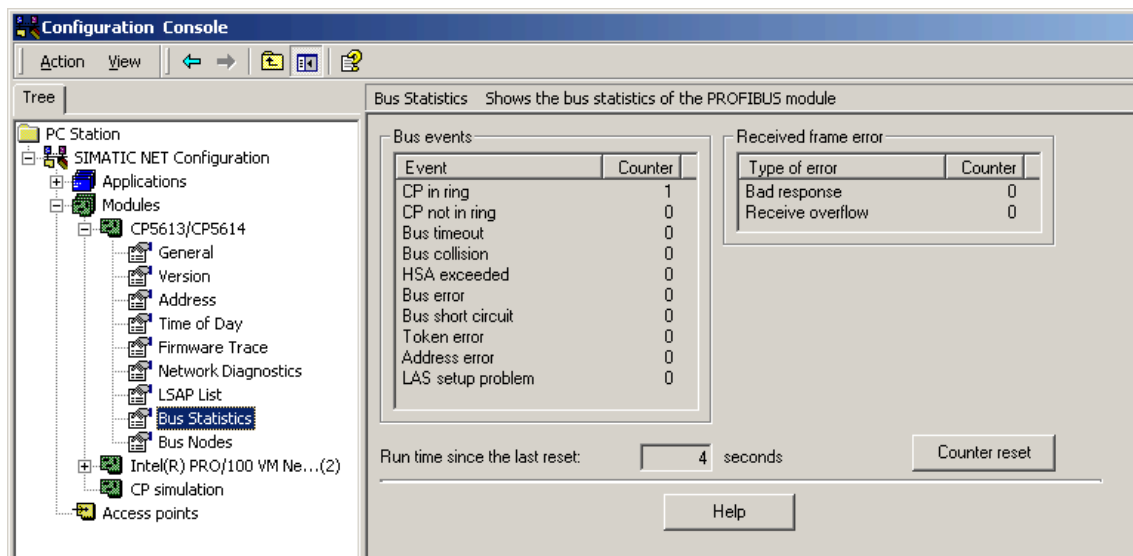

DIGSIKOM158.tif

Fig. 7-64 Configuration Console, Bus Statistics

- Bus Node
Your CP5613 must be **active**; all other bus nodes may only be marked as passive.

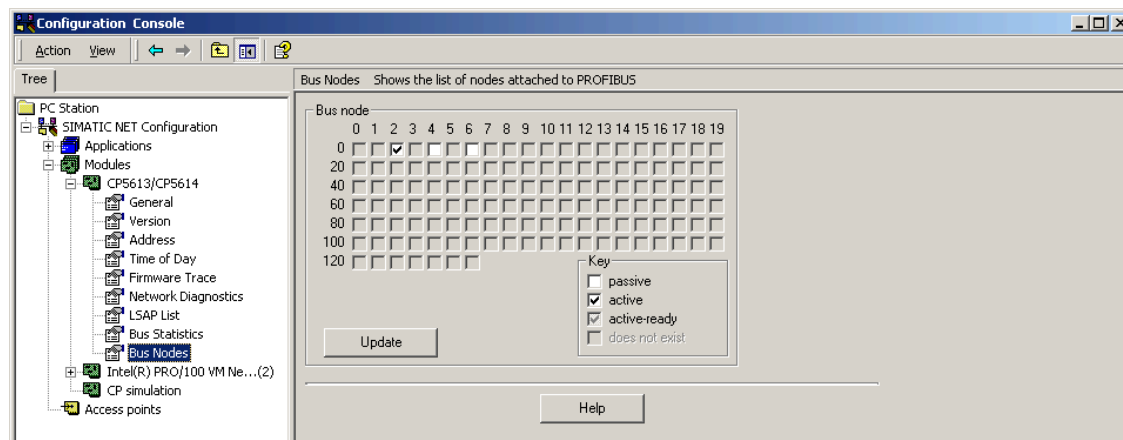

DIGSIKOM159.gif

Fig. 7-65 Configuration Console, Bus Node

Wrong Access Point for S7ONLINE

If your configuration data cannot be downloaded to the communications processor, check the access point **S7ONLINE** in the Configuration Console:

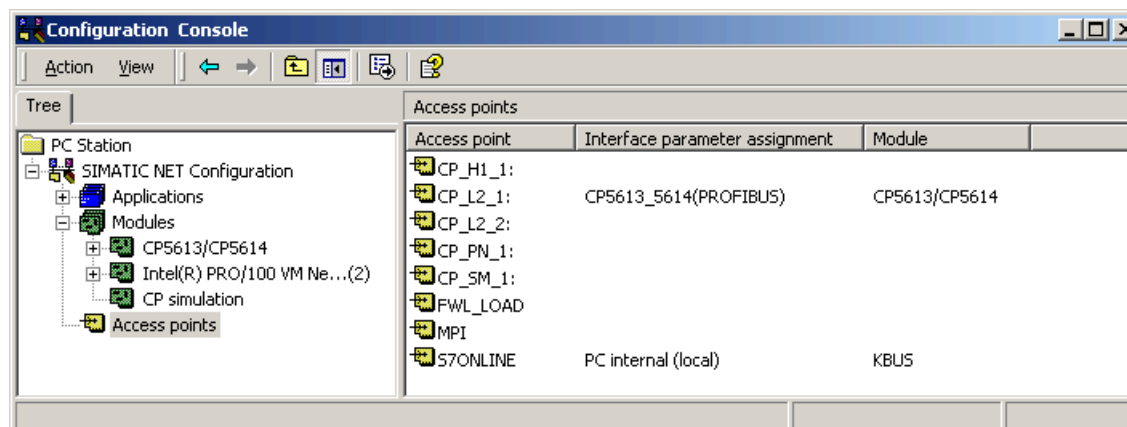

DIGSIKOM160.gif

Fig. 7-66 Configuration Console, Access Points

- If this entry is not set to **PC internal (local)**, double-click the entry.
- Set the access point to this value in the **Properties of S7Online** and close the dialog with **OK**.

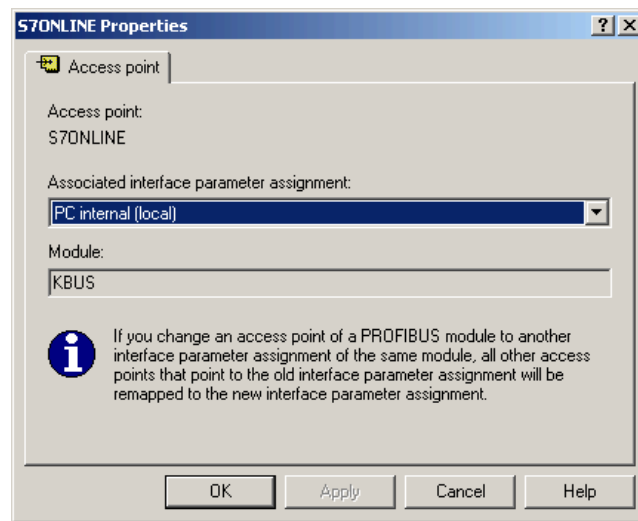

DIGSIKOM049

Fig. 7-67 Properties of S7Online

7.8.3 Procedure with SIMATIC NET NCM PC Edition

If you do not have a SIMATIC STEP 7 full version, proceed as follows:



NOTE

The configuration is almost identical to the procedure described in Chapter 7.8.2 so that a detailed description of the software is not necessary.

Prerequisites

- You need two PCs.

Installation

- Install only the NCM component (SIMATIC NCM PC V5.2) of SIMATIC NET on PC 1.
- Install DIGSI and the PROFIBUS card (and its drivers) on PC 2.

Configuration on PC 1

Configure, with the help of the NCM components on PC 1, the PC station with the communications processor and application (see also Chapter 7.8.2):

- Select **SIMATIC NCM PC MANAGER** from the **Start** menu.
- Select **Insert > Station > 1 SIMATIC PC Station** to create the PC station.
- Open the **Configuration**.
- Configure the communications processor **CP5613**.
- Create a user application. Assign the name in **Properties** of the application; note that the VFD number must be "1" in the **FMS** tab (see Figure7-51).
- Assign the application in **Properties** of the communications processor to the CP5613.
- Select **Save + Convert** to close the configuration.
- Select **Options > Configure Network** to start the application **NetPro**.
- Assign the name of the XDB export file in **Properties** of the PC station (see Figure7-53).
- Adding devices:
Select **Other station** in the right area under **Stations** and place it on your network chart via Drag & Drop.
- Assign its name (e.g. SIPROTEC + FMS number + communication reference) in **Properties** of the station in the **General** tab.
- Click **New** in the **Interfaces** tab under **Properties** of the station and select **PROFIBUS** as the type of connection. Click **OK**.
- Select a subnet in the **Properties - PROFIBUS interface** dialog box (see Figure7-54) and assign the device address. Click **OK**.
- Click on the area **Application** in the object of the **PC Station**.
- Insert a new connection. To this purpose select the device and **FMS Connection** as the type of connection. Click **Apply**.
- Change to the properties of the **FMS Connection** and select the station and connection profile (see Figure7-59). Click **OK**.
- Repeat this procedure for all SIPROTEC devices which are to be connected to the PROFIBUS FMS network.
- Select **Network > Save and Convert** and confirm the confirmation query with **OK**.
- Start the Windows Explorer and change to the XDBs directory of your project (e.g. Programs\Siemens\ SIMATIC.NCM\S7PROJ\Project\XDBs) and copy the XDB file to a disk.

Configuration on PC 2

- Create a project in DIGSI 4 and add the necessary SIPROTEC devices.
- Check under **Options > Configure DIGSI 4** the data in the **PROFIBUS FMS** tab (see Figure7-54).
- Check the PROFIBUS address and communication reference (CR) from the properties of the devices (see Figure7-28).
- Import the XDB configuration file on PC 2 in the **Station Configuration Editor** (see page 425).

Termination

- You can establish the connection to your SIPROTEC devices now.

7.9 Supplementary Protocols

SIPROTEC 4 devices from system firmware Version 4.2 up also allow communication on the basis of

- PROFIBUS DP,
- DNP 3.0 and
- MODBUS.

In DIGSI 4 these protocols are called **Other protocols**.



NOTE

These protocols can only be used for communication between the SIPROTEC device and a control center. Communication between DIGSI 4 and a SIPROTEC 4 device on the basis of one of the three aforementioned protocols is **not** possible.

Operations

Proceed as follows in order to establish and configure the communication via these **Other protocols**:

- Specify the interface in DIGSI 4.
- Select the mapping file and edit it.
- Configure the information.
- Initialize your SIPROTEC 4 device.

7.9.1 Specifying the System Interface in DIGSI 4

Specify the configuration of the system interface in DIGSI 4.

Proceed as follows:

- Start DIGSI 4 and open your project.
- Select a **SIPROTEC 4 device** and click on **Object properties** via the context menu.
- Select the **Communications Modules** tab in the **Properties - SIPROTEC 4 device** dialog box.

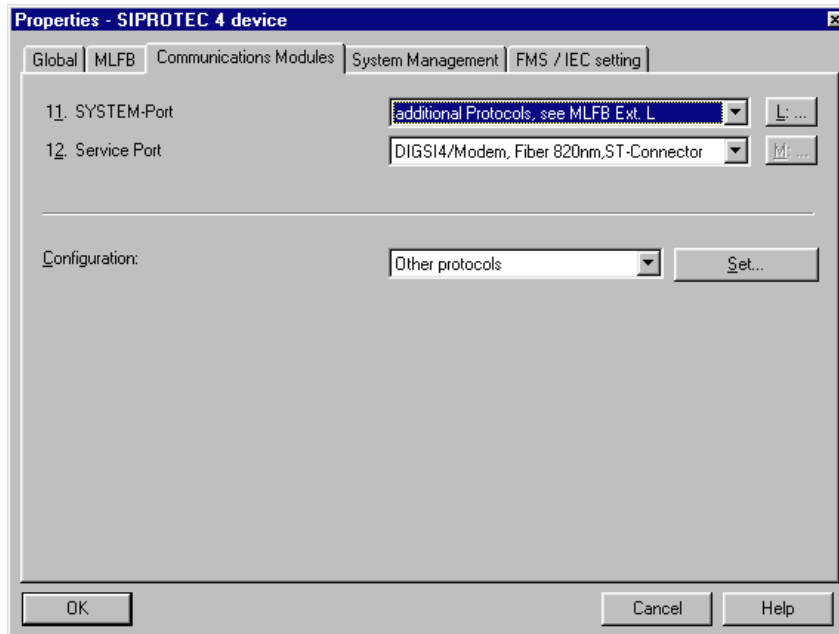

DIGSIKOM105

Fig. 7-68 Properties - SIPROTEC 4 device, Communications Modules tab

Selecting the System Interface

- Select the **Other protocols** setting from the **System interface** drop-down list box. After this setting has been selected, the **L:...** command button is activated. Click this command button. The **Extended MLFB** dialog box is opened.

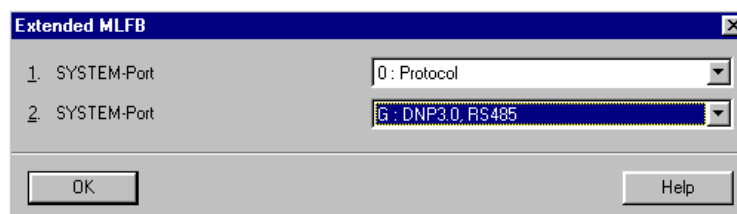

DIGSIKOM106

Fig. 7-69 MLFB extension

Selecting the Protocol

Specify which protocol you want to use and how the communication line is implemented.

- In the lower drop-down list box, select the name of one of the additional protocols. The selection has to be compatible with the installed interface and the version of the communication line.

The upper drop-down list box only permits the selection of the setting **Protocols**.

- Confirm by clicking OK.
- Click on **OK** in the **Properties - SIPROTEC 4 device** in order to accept the settings.

7.9.2 Selecting and Editing a Mapping File

DIGSI 4 offers one or more standard configurations for the selected protocol. These have to be adapted to your particular application.

If several mapping files are offered, select the file which best corresponds to your application with regard to the scope of information contained (see Section **Selecting a Mapping File**). The scope of information of the individual protocols is documented in the SIPROTEC 4 descriptions of the various communication profiles.

For the documentation on the mapping files refer to the directory ...\\MANUALS\\Communication on the DIGSI 4 CDROM.

Carry out the protocol-specific settings (see the section on **Altering the Parameter Values**).

For PROFIBUS DP interfaces modify the scope of information on the interface (see Chapter 7.9.3).

Proceed as follows:

- Open your SIPROTEC 4 device and double-click **Interfaces** in the function selection box. You can select a mapping file now in the **Other protocols** tab.

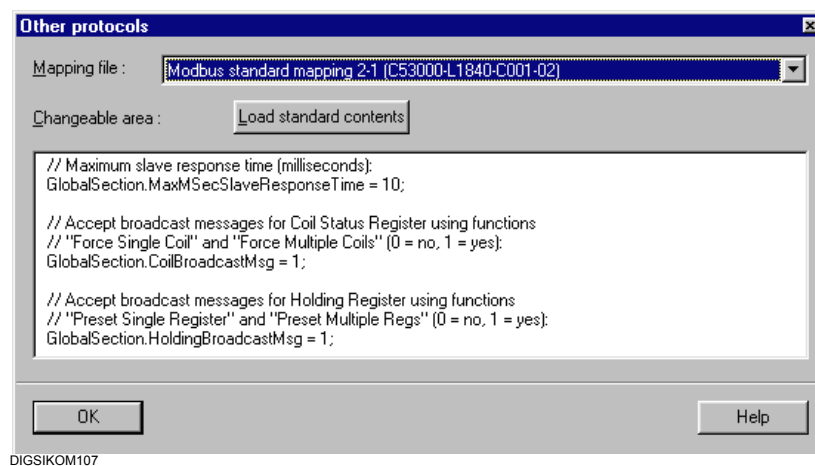

Fig. 7-70 Interface Settings – Other protocols on the device

Selecting a Mapping File

- Select the name of a mapping file from the **Mapping file** drop-down list box. The choice depends on the system interface settings carried out in the **Extended MLFB** dialog box.



NOTE

Starting with version 4.2, DIGSI 4 provides mapping files for PROFIBUS DP which allow you to change the configurations of the system interface. As soon as you select one of these mapping files, changes are made to the parameter set of the SIPROTEC 4 device. If you had previously selected another mapping file, the original state of the parameter set **cannot be restored**.

Altering the Parameter Values

- Adapt the values of some parameters manually, for example the baud rate, depending on the selected protocol. In this case the names of the parameters with preset values are displayed in the **Changeable area** box. Adapt the displayed values to your requirements. For further information please refer to the SIPROTEC 4 description of the various communication profiles.



NOTE

If you use the **PROFIBUS DP** protocol for communication, you need to set the PROFIBUS DP address in the **Changeable area** box. Please do not alter any settings in the **FMS/IEC setting**.

Accepting Settings

- Click **OK** to apply your settings.

DIGSI 4 changes the parameter set in accordance with the selected mapping file.

Error Indications

An error indication is displayed if you have carried out an impermissible change in the changeable area while editing the mapping file.

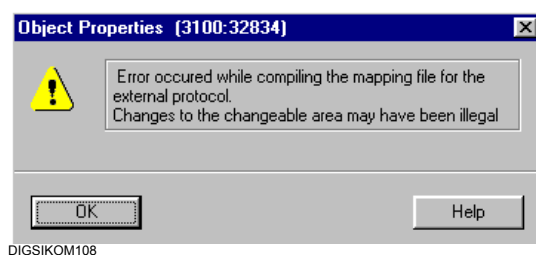

Fig. 7-71 Error indication due to impermissible entry in the mapping file

- Click **OK** to confirm the indication.
- Open the **Properties - SIPROTEC 4 device** again and correct your changes. If appropriate, load the standard setting.



NOTE

Changed parameter values are checked for their plausibility. If communication is not possible, check the new values which have been entered.

7.9.3 Allocating Information Items

The selection of the mapping file results in a basic configuration of the items of information to the system interface which is contained in the mapping file.

If you have selected such a mapping file for a **PROFIBUS DP** interface, the configuration in the device matrix can be altered similarly to the method described in Chapter 5.5.8. You can replace individual items of information contained in the standard mapping, but you cannot change the amount of information.

Proceed as follows in order to carry out the configuration:

- Open the SIPROTEC 4 device and double-click **Configuration** in the function selection in order to display the device matrix.

The column **S** for the system interface is displayed as the destination for information.

Changing the Configurations

Both columns initially show the preset initial configurations.

- Click in the column on the cell of the information and select **X (configured)** or **_ (not configured)** in the context menu. The corresponding properties dialog box opens as soon as you configure new information to the system interface.

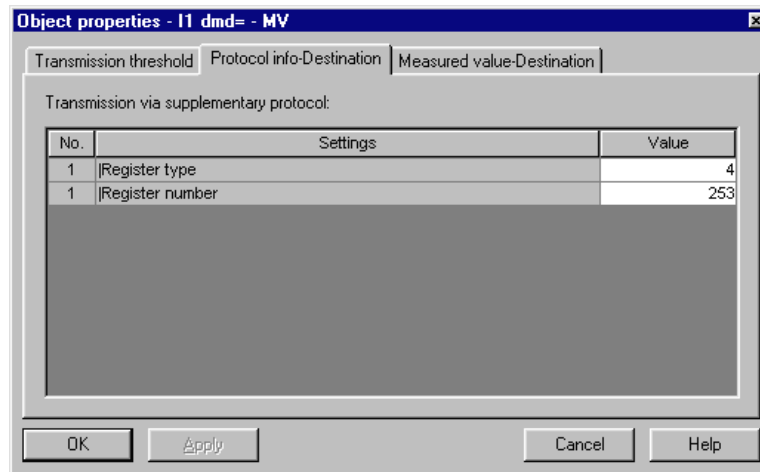

DIGSIKOM136

Fig. 7-72 **Object properties** dialog box, **Protocol info - Destination** tab

This dialog box always contains one of the tabs **Protocol info - Destination** or **Protocol info - Source**, depending on the configuration to the system interface as destination or source. If a measured value is configured to the system interface as a destination, the **Measured value - Destination** is also displayed.

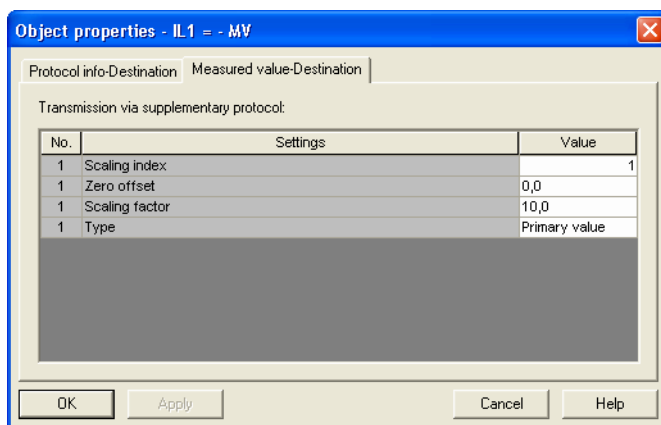

digsikom137.gif

Fig. 7-73 Object properties, Measured value - Destination tab

Setting Protocol Parameters

The parameters of the **Protocol info - Destination** or **Protocol info - Source** are protocol-specific.

The meaning of the individual parameters is specified in the protocol documentation which is delivered with the communication module.

Scaling the Measured Values

You can change the scaling of measured values in the **Measured value - Destination** tab

The scaling of a measured value is usually necessary in cases where the resolution of a measured value needs to be reduced. If, for example, a measured value existing in 32-bit form is reduced to 16 bits, important information may be lost. You can counteract this effect by scaling the measured value.

- Select the appropriate index in the **Scaling index** line.
Each **Scaling index** is assigned values of the parameters **Zero offset**, **Scaling factor** and **Type**. The assigned values are different for the various device types and protocols.

The value of the **Zero offset** parameter is added to the measured value.

The value of the **Scaling factor** parameter is multiplied with the measured value.

With the **Type** parameter, the type of the measured value (percentage value, primary value or secondary value) is defined.



NOTE

The values of the parameters **Zero offset** and **Scaling factor** can be changed. Any change also affects all other measured values with the same **Scaling index**. In the case of a change, a warning message is issued.

The **Type** parameter cannot be changed.

You may be able to edit other settings depending on the protocol you are using, for example **Threshold value** for the protocol **DNP 3.00**.

Changing Settings Afterwards

If you want to change the settings for the protocol or for the measured-value scaling afterwards, open the properties dialog box of the respective information and change the values in the **Protocol info - Destination** or **Protocol info - Source** and **Measured value - Destination** tabs.

7.10 Connection via Ethernet

With this type of connection, the PCs and the SIPROTEC 4 device communicate via an Ethernet connection.

To be able to establish a link between a computer and a SIPROTEC 4 device, the values of the serial port settings of the two components must be identical. Some relevant setting values can be set in the DIGSI 4 Device Editor. Others are displayed but cannot be set. You would have to use other programs to edit them, for example, DIGSI Manager.

To select and check settings for PC and device interfaces:

- Right-click **Interface** in the list view of DIGSI device editing. Click **Open object** in the context menu. You can also double-click **Interfaces**. In either case, the **Interface Parameters** dialog box is displayed.
- Check the settings under each tab and make any changes that are necessary.
- Click optionally **DIGSI > device** to transfer to the SIPROTEC 4 device changed settings in the **Online** operating mode.
- Click **Apply** to accept changed settings. The dialog box remains opened. Click **OK** in order to accept settings and close the dialog box. In either case, the values are placed in the memory of the computer. The setting values are not yet stored in the parameter set.

The **Interface Parameters** dialog box has a different number of tabs with setting options for the parameters of the interface in question depending on how the computer and the SIPROTEC 4 device are equipped.

The "Serial interface at the PC", "VD addresses" and "Operator interface" tabs are always available.

"Ethernet at the PC" tab

This tab displays the settings for an Ethernet interface in the PC. You will find these settings in **DIGSI Manager, Options > Configure DIGSI 4, Ethernet** tab.

"Ethernet at the device" tab

This tab displays the settings for the Ethernet interface in the **SIPROTEC 4 device**. This tab is displayed if the **SIPROTEC 4 device** has an Ethernet system interface. You will find these settings in **DIGSI Manager, Object properties of the device, Communication Parameters** tab.

For further information on the settings refer to the Online Help of DIGSI 4.

Maintenance and Immediate Help, Test Functions

This chapter provides information on the maintenance measures required or recommended to maintain the reliability of a SIPROTEC 4 device, on the components which have to be checked and replaced routinely, on the testing and diagnostic functions and on the steps to be taken in cases of failures of the device. The chapter is intended for the persons responsible for operation as well as for the protection engineers.

Contents

8.1	General	448
8.2	Routine Checks	449
8.3	Replacing the Battery	450
8.4	Test and Diagnostic Functions	456
8.5	Troubleshooting	463
8.6	Corrective Action / Repairs	465
8.7	Return	469

8.1 General

SIPROTEC 4 digital protective and control devices are designed to require no special maintenance measures. The only maintenance measure required is to change the battery. All the measuring and signal processing circuits are solid-state. All the input modules are also solid-state. The binary outputs are provided with barriers.

Since the device is self-monitoring to a great extent, hardware and software problems are signaled automatically. This ensures the high availability of the device. Therefore, maintenance checks in short intervals are not required.

Hardware Faults

In case of recognized hardware faults

- The device blocks itself automatically,
- The "Device ok" relay drops out and signals the fault via its breaking contact.

If a fault is recognized in the external measuring circuits, the device normally only provides an indication.

Software Problems

Recognized software problems

- Trigger resetting and restarting of the processor.
If the fault is not eliminated by the restart, up to three further restarts are carried out. The device is then automatically taken out of operation.
Display is carried out via the red "ERROR" LED on the front panel.
- The "Device ok" signal relay drops out and signals the fault via its breaking contact.

The reactions to faults and errors can be viewed chronologically as operational indications (see Chapter 6.2 Indications).

If the device is connected to the control system for switchgear or other central control devices, the monitoring indications are also signaled via the serial interface to the control center.

8.2 Routine Checks

Characteristic curves or pick-up values require no routine checks since they are part of the firmware programs which are monitored continuously.

The normally scheduled interval for plant maintenance can be used to carry out operational checks of the protective and control devices. Maintenance is used primarily to check the interfaces of the SIPROTEC device, i.e. the coupling with the plant.

The following steps are recommended. If a fault is diagnosed, refer to the information in Chapter 8.5 Troubleshooting.

- Verify that the green "RUN" LED on the front panel is illuminated and the red "ERROR" LED is not.
- Check that the states of the LEDs on the front panel provide an accurate image of the current state of the device and the plant.
- Press the LED push-to-test button. All the LEDs except the red "ERROR" LED are illuminated.
- Read out the operating measurement quantities (see Chapter 6.3) and compare them to the actual measurement quantities for checking the analog inputs.
- Read out the operating indications (see Chapter 6.2).
Ensure that there are no entries on device faults, measurement quantities or other implausible information.

Carry out a restart of the device to initiate a complete hardware test. The device is not ready for operation during the restart.

- Use the operator control panel to select the **Device Reset** function or DIGSI 4 to select the **Restart** function. You require the password for **testing and diagnostics** to this purpose.
- Use the **Test** function of DIGSI 4 to check the binary inputs and outputs. The **Device Inputs and Outputs** menu item contains the **actual** states of all the LEDs, binary inputs and binary outputs in a table. Compare these states with the actual current conditions.



NOTE

Changing the switching states by means of the test functions must be avoided during operation, since any change immediately affects the inputs and outputs of the device and thus the plant! This may lead, for example, to non-interlocked switching!

- Check the command circuits. The procedure is described in Section Chapter 6.6.



NOTE

The use of the operator control panel of the device and DIGSI 4 are described in Chapter 2 and Chapter 4.

8.3 Replacing the Battery

8.3.1 General

The indications and the fault record data of the device are saved in the battery-buffered RAM. In order to retain them during a supply voltage failure a buffer battery has to be used. The buffer battery also maintains the internal system clock with calendar in case of an auxiliary voltage failure.

It is recommended to replace the battery when **Fail Battery** is displayed, or after approx. 10 years of operation at the latest.

Recommended battery:

Lithium battery 3 V/1 Ah, type CR 1/2 AA, e.g. VARTA Order No. 6127 101 501

The procedure for replacing the battery depends on the device design. We differentiate between devices for panel flush mounting, cubicle mounting, panel surface mounting or mounting with detached operator control panel.

8.3.2 Battery Replacement at Panel Flush Mounted and Cubicle Mounted Devices



NOTE

All the configuration and setting values of the device are stored retentively against voltage interruption. They are stored independently of the buffer battery. They are therefore not lost when the battery is replaced or when the device is operated without a battery.

Proceed as follows in order to replace the battery.

The battery is installed on the front edge of the CPU board. The front panel has to be removed in order to replace the battery.

- Read out the indications and metered values of the device via DIGSI 4. To do so, connect your PC to the front operator interface of your device. DIGSI 4 stores the read-out information in the PC.
- Have the replacement battery ready.

NOTICE

- Do not short the battery!
 - Do not reverse the polarity of the battery!
 - Do not recharge the battery!
-

NOTICE

Electrostatic discharges over component terminals, conductor paths or pins must always be avoided by first touching earthed metal parts. Do not withdraw or plug in powered interface connections!



CAUTION

Even after the supply voltage has been disconnected or the module has been removed, hazardous voltages may still be present in the device (capacitors can still be charged)!

- Switch off all poles of the auxiliary voltage of the device at the circuit-breaker.
- Remove the covers on the front panel and loosen the screws which can then be accessed.
- Pull off the front panel and fold it carefully away to the side. Remove the plug-in connector of the ribbon cable between the processor board CPU (❶) and the front cover from the front cover. Spread the plug connector latches at the top and bottom so that the plug connector of the ribbon cable is pressed out.
- The battery is positioned on the bottom front of the CPU board (❶ in Fig. 8-1).

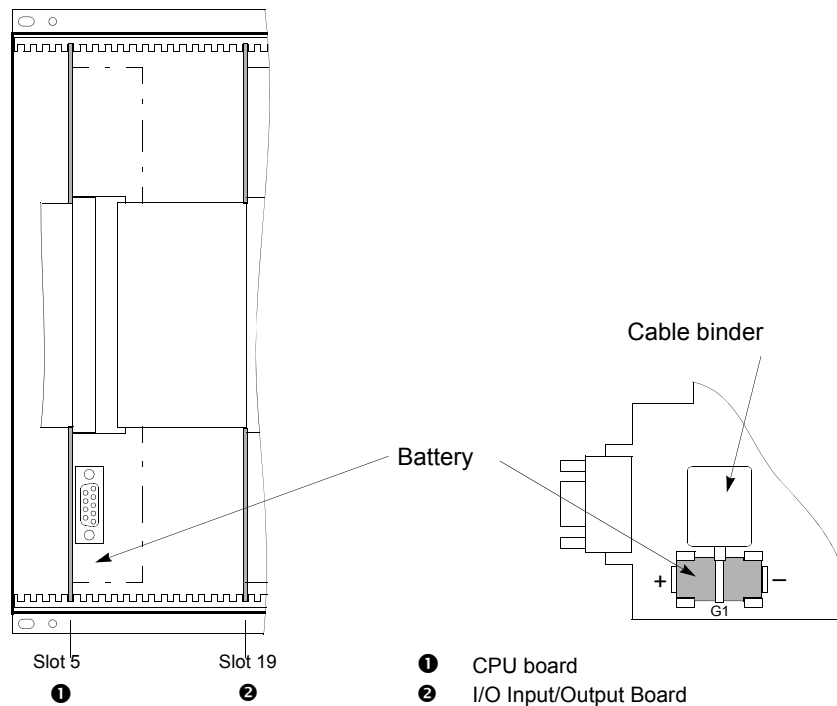

Fig. 8-1 Front view without front panel - position of the buffer battery (simplified and reduced)

8.3 Replacing the Battery

- Remove the old battery from the snap-in fastener by using the cable binder as shown in Fig. 8-1.
- Remove the cable binder from the old battery and attach it to the new battery.
- Press the new battery firmly into the snap-in fastener as shown in Fig. 8-1.
- Plug the plug connector of the ribbon cable between the CPU board and the front panel of the device onto the plug connector of the front panel. Do not use any force and ensure that no connecting pins are bent!
- Press the latches of the plug connector together.
- Replace the front panel and fasten it to the housing by means of the screws.
- Replace the covers.
- Switch the auxiliary voltage back on and download the indications and metered values back to the device after it has restarted.
- Set the internal system clock if it was not synchronized automatically via one of the serial interfaces. For further information please refer to Chapter 4.3.7.

NOTICE

The spent battery contains Lithium. Dispose of it as specified by the applicable regulations!

- Do not reverse the polarity of the battery!**
 - Do not recharge the battery!**
 - Do not throw the battery into a fire!**
 - Explosion hazard!**
-

8.3.3 Battery Replacement for Devices with Detached Operator Panel**NOTE**

All the configuration and setting values of the device are stored retentively against voltage interruption. They are stored independently of the buffer battery. They are therefore not lost when the battery is replaced or when the device is operated without a battery.

Proceed as follows in order to replace the battery.

The front panel of the operator control panel contains a snap-in fastener called G2 for a new battery.

Proceed as follows:

- Read out the indications and metered values of the device via DIGSI 4. To do so, connect your PC to the front operator interface of your device. DIGSI 4 stores the read-out information in the PC.
- Have the replacement battery ready.

NOTICE

- ❑ Do not short the battery!
 - ❑ Do not reverse the polarity of the battery!
 - ❑ Do not recharge the battery!
-

- Remove the covers from the front panel of the operator control panel.
 - Loosen the screws which are then accessible and remove the front panel.
 - Press the new battery firmly into the snap-in fastener as shown in Figure 8-2.
- The battery located at the front edge of the CPU board must not be replaced.

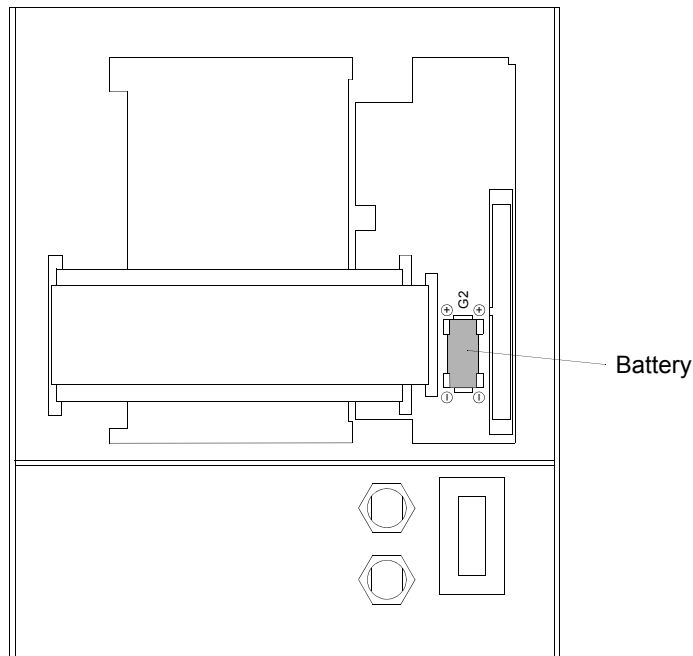

Fig. 8-2 Rear view of the front panel, enclosure size $1\frac{1}{2}$ with inserted battery

- Replace the front panel and fasten it to the housing by means of the screws.
- Replace the covers.
- Switch the auxiliary voltage back on and download the indications and metered values back to the device after it has restarted.
- Set the internal system clock if it was not synchronized automatically via one of the serial interfaces. For further information please refer to Chapter 4.3.7.

NOTICE

The spent battery contains Lithium. Dispose of it as specified by the applicable regulations!

- Do not reverse the polarity of the battery!
 - Do not recharge the battery!
 - Do not throw the battery into a fire!
 - Explosion hazard!
-

8.3.4 Battery Replacement for Panel Surface Mounted DevicesI

The battery is located at the front edge of the CPU board. The device has to be removed from the wall before the battery can be replaced.

The following section describes the procedure for replacing the battery.

- Read out the indications and metered values of the device via DIGSI 4. To do so, connect your PC to the front operator interface of your device. DIGSI 4 stores the read-out information in the PC.
- Have the replacement battery ready.



NOTE

All the configuration and setting values of the device are stored retentively against voltage interruption. They are stored independently of the buffer battery. They are therefore not lost when the battery is replaced or when the device is operated without a battery.

NOTICE

- Do not short the battery!
 - Do not reverse the polarity of the battery!
 - Do not recharge the battery!
-

NOTICE

Electrostatic discharges over component terminals, conductor paths or pins must always be avoided by first touching grounded metal parts. Do not plug or withdraw interface connections under power!



CAUTION

Even after the supply voltage has been disconnected or the module has been removed, hazardous voltages may still be present in the device (capacitors can still be charged)!

- Switch off all poles of the auxiliary voltage of the device at the circuit-breaker.
 - Screw the device off the wall.
 - Replace the old battery with the new one as described in Chapter 8.3.2.
 - Screw the device back firmly onto the wall.
 - Switch the auxiliary voltage back on and download the indications and metered values back to the device after it has restarted.
 - Set the internal system clock if it was not synchronized automatically via one of the serial interfaces. For further information please refer to Chapter 4.3.7.
-

NOTICE

The spent battery contains Lithium. Dispose of it as specified by the applicable regulations!

- Do not reverse the polarity of the battery!**
 - Do not recharge the battery!**
 - Do not throw the battery into a fire!**
 - Explosion hazard!**
-

8.4 Test and Diagnostic Functions



DANGER

Persons carrying out test functions must be suitably qualified and have a good knowledge of system conditions. Improper handling can cause death as well as serious injury or damage to property.

In the **Online** operating mode, DIGSI 4 allows you to carry out various test and diagnostic functions for a SIPROTEC device, such as:

- Activation/de-activating the test mode and transmission blocking,
- Testing binary inputs, binary outputs and LEDs,
- Carrying out a circuit-breaker test,
- Initiating a test fault record,
- Outputting test indications manually via the system interface,
- Displaying the system load.

The test functions are activated via the menu bar and via various functions which are accessed through the list view of the device.

- Open the device in the **online** mode (see Chapter 4.3.4)
- Click in the DIGSI 4 navigation window on **Test**. All the subordinate objects are displayed in the data pane.

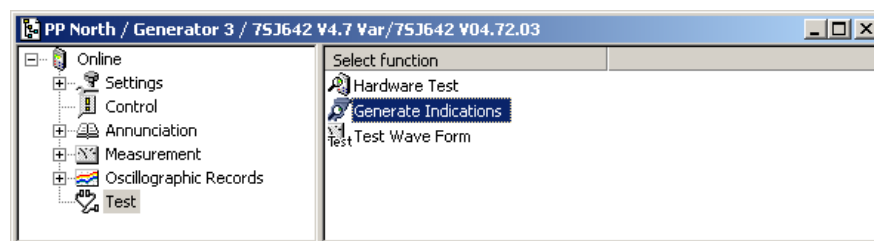

DIGISGB006.tif

Fig. 8-3 Test Functions

- Hardware Test (device inputs and outputs)**
Tests of the operational statuses of LEDs, binary outputs and binary inputs of a SIPROTEC device.
- Generate Indications (Test Event for System Port)**
Outputs test indications manually via the system interface.
- Start Oscillographic Fault Recording**
Initiates a fault recording for test purposes.
- Circuit Breaker Test Function**
Carries out a circuit-breaker test (tripping or reclosing).

Depending on the device model not all the test functions are always available. The test functions are protected by a password.

8.4.1 Activating and De-activating the Test Mode

If test mode is activated, indications output to the control center from a SIPROTEC 4 device are marked with an additional test bit. This test bit allows you to ascertain whether an indication has been output during a test. In this way, responses to indications which would be required in normal operation can be suppressed.

Proceed as follows:

- Select **Device > Test Mode**.
If the test mode was activated, it is de-activated and vice versa. Activated test mode is indicated by a check mark at the menu command.
- Enter the password for testing and diagnostics.

When you activate or de-activate the test mode, a message is displayed in the left-hand part of the status bar. Bar segments additionally indicate the progress of the procedure.

8.4.2 Activating and De-activating the Transmission Block

If the transmission block is activated, no indications are output via the system interface of a SIPROTEC 4 device. A transmission block can be activated or de-activated depending on the current state.

Proceed as follows:

- Select **Device > Block Data Transmission**.
If the transmission block was activated, it is de-activated and vice versa. Activated transmission block is indicated by a check mark at the menu command.
- Enter the password for testing and diagnostics.

When the transmission block is switched on or off, a message is displayed in the left-hand part of the status bar. Bar segments additionally indicate the progress of the procedure.

8.4.3 Testing Device Inputs and Outputs (Hardware Test)

The hardware test encompasses testing of the binary inputs, binary outputs and LEDs of a SIPROTEC device. When this test function is started, the test mode is activated automatically and all the indications are identified by a test bit.

Proceed as follows:

- Select **Hardware Test** and open the **Hardware Test** dialog box via the **Open Object** context menu.

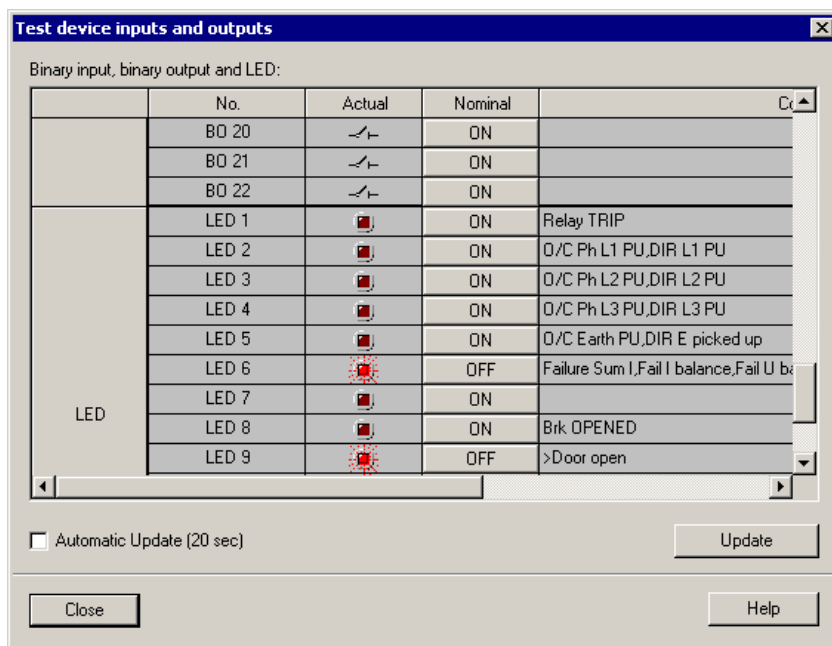

DIGISGB007

Fig. 8-4 Hardware test, operational states LEDs, binary outputs



The display area of the dialog box is subdivided vertically into three groups:

- BI** for binary inputs,
- BO** for binary outputs and
- LED** for LEDs.

- Click on the designation of the group in order to display or hide the information on the group.

In the **No.** column, the numbers of the individual binary inputs, binary outputs, and LEDs are displayed. The numbers are shown with the prefix **BI**, **BO**, or **LED**.

In the **Actual** column, the actual state of the hardware component is displayed. The state is visualized symbolically, e.g. by the symbol of an LED that is switched off or on or by the symbols of making or breaking switching contacts.

BE 4		Low	LS
BE 5		High	LS

DIGISGB010

Fig. 8-5 Visualization of the actual states for binary inputs

The **Nominal** column displays the possible setpoint state of a hardware component in clear test. Since the hardware components only have two states each, the state which is opposite to the actual state is always displayed.

The **Configured** column indicates what equipment, commands, or indications are configured to the hardware components.

- Click on the command button in the **Nominal** column in order to change the operating state of the corresponding hardware components.



DANGER

Be aware that the switchover of operational states on the SIPROTEC device really takes place!

This activates equipment connected to the relays, such as circuit-breakers or disconnectors.

If you do not want this to happen, you need to activate the output blocking on the SIPROTEC device (see Chapter 6.7.4).

Please be also aware that after the binary inputs have been activated, the state of the binary input processed in the device does not agree with the actual one.

When you leave the Test device inputs and outputs dialog, a restart is carried out. This action deletes fault records, network faults, etc.

- Enter the password for **testing and diagnostics**.

If the password you entered was correct, an enable is set and the command for changing the setpoint state is output. The enable for further operating state changes is retained for further tests until you close the **Hardware Test** dialog box.

When the **Test device inputs and outputs** dialog box is opened, the current operating states of binary inputs, binary relays, and LEDs are read in and displayed. The display is updated in different ways.

If a command to change to another operational state is successful, the display for the hardware component is updated.

- Click **Update** to update display of the states of all hardware components manually.
- Select the **Update Cyclically** check box in order to set cyclic updating of the display of the current states of all the hardware components.
- Click **Close** in order to terminate the hardware test.

The **Test device inputs and outputs** dialog box is closed. This sets all the hardware components back to the operating state specified by the plant states.

8.4.4 Carrying Out a Circuit-breaker Test

Circuit-breaker tests can be carried out with

- Only tripping and
- Tripping and subsequent reclosing.

Proceed as follows:

- Select **Circuit Breaker Test** and open the **Test Circuit Breaker** dialog box by means of the **Open Object** context menu.

In the background the **Spontaneous Indications** window is also opened. This window displays indications on the results of a circuit-breaker test.

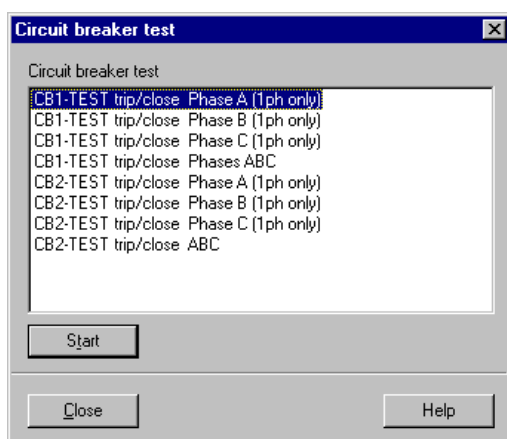

DIGISGB115

Fig. 8-6 Testing a circuit-breaker

The dialog box offers single-pole and three-pole tests.

- Select the name of the required test.
Click **Start**.



DANGER

A successfully launched test cycle may cause the circuit breaker to close if an external automatic reclosing device exists!

- Enter the password for testing and diagnostics.

If the password you entered was correct, an enable is set and the command for the test is output. The enable is retained for further tests until you close the **Test circuit-breaker** dialog box.

The test results are displayed in the **Spontaneous Log** window.

- Click in the **Circuit breaker test** dialog box on **Close** in order to terminate the procedure.

8.4.5 Initiating a Test Fault Record

For test purposes you can use DIGSI 4 to initiate a fault recording manually.

Proceed as follows:

- Select **Test Fault Record** and open the **Test Fault Record** dialog box by means of the **Open Object** context menu.

The test fault recording is started with the fault record length currently set. During the fault recording, an indication is output in the left-hand part of the status bar. Bar segments additionally indicate the progress of the procedure.

The procedure for changing the setting values for fault records is described in Chapter 5.17.

The scope of delivery of DIGSI 4 includes the program **ComtradeViewer**. This program allows the display of fault-record data which are written in a fault-record file. The optionally available program **SIGRA 4** offers numerous graphical possibilities of evaluating fault records.

- Double-click on the name of the fault in order to open the evaluation program.
By default the **ComtradeViewer** program is opened. If **SIGRA 4** is installed, it is opened.

8.4.6 Outputting Indications

DIGSI 4 offers you the possibility of outputting test indications manually. During this test, all indications are marked by an additional test bit.

Proceed as follows:

- Select **Generate Indications** and open the **Generate Indications** dialog box by means of the **Open Object** context menu.

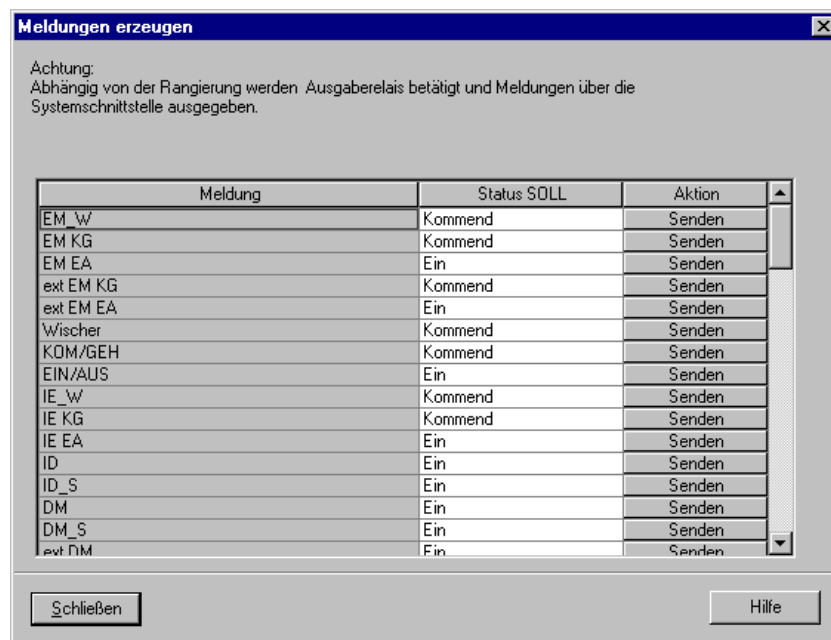

digsigb118.tif

Fig. 8-7 Generate Indications

The column **Indication** shows the display texts of indications which can be set. Which indication types are displayed depends on the type of the SIPROTEC device.

In the **SETPOINT status** column you define a value for the indications that you want to test. Depending on the type of indication, there are drop-down list boxes, spin boxes, or input fields for this purpose.

- Click in the **SETPOINT status** column on the field and select the value which the indication is to assume, for example **Off**.
- Click in the **Action** column on the **Send** command button in order to output an indication. Indications are output individually.
- Enter the password for testing and diagnostics.

If the password you entered was correct, an enable is set and the command for changing the setpoint state is output. The enable is retained for output of further indications until you close the **Generate Indications** dialog box.

Additional information is shown for a device with **IEC 61850** communication. To the right in the dialog, a list is displayed which lists the IEC 61850 objects of the selected message. These objects are output via system interface (to SICAM PAS, for example).

- Click **Close**, in order to terminate the process.

8.4.7 Displaying the System Load

For diagnostic purposes, it is possible to read out data on the system load. These data are not important for the normal operating state.

Proceed as follows:

- Select **Device > Resource Meter** and select the **Resource Meter** dialog box.

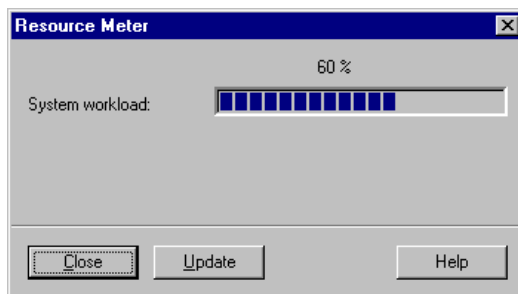

DIGISGB013

Fig. 8-8 System load

The system load is displayed statically. That means that the system load at the time the dialog box is opened is ascertained and displayed. If the system load changes while the dialog box is opened, the display is not updated automatically.

- Click **Update** to update the display manually.
- Click **Close** in order to terminate the dialog box.

8.5 Troubleshooting

If the device indicates a defect, the following procedure is recommended:

If none of the diodes on the device front panel are lit, verify the following points:

- Are the modules inserted correctly in the slots and locked by the front panel?
- Are the plug connectors of the ribbon cable plugged in and the latches latched in?
- Is the auxiliary voltage sufficiently high and, if appropriate, with the correct polarity at the corresponding connections (for further information please refer to the overview diagrams in the appendix of the device manual)?
- Is the fuse link of the miniature fuse in the power supply unit of the module intact (see Figure 8-12)? If necessary, replace the miniature fuse (see Section 8.6.2).

If the red "FAULT" display is lit and the green "RUN" display is off, carry out a device restart (see Chapter 8.2).

If **MONITOR** is displayed in the device display, you can re-initialize the device by using DIGSI 4 **Reset**:

MONITOR	01/05

Equipment data ->	1
User interface ->	2
System I-face ->	3
Reset ->	4
Siemens intern ->	5

Fig. 8-9 Monitor display in the device display

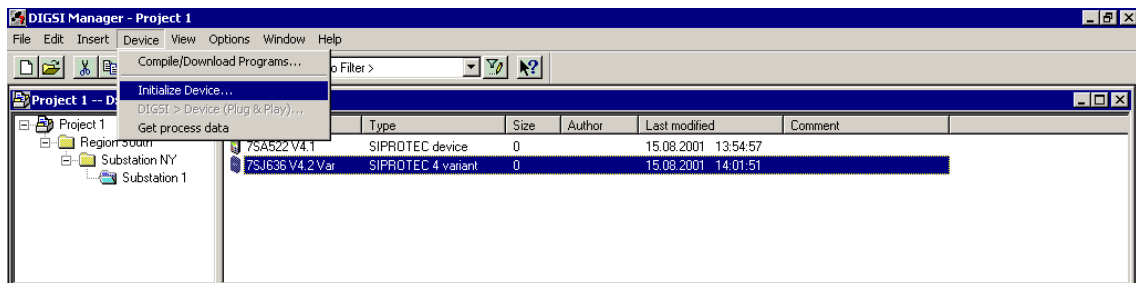

digsif630.gif

Fig. 8-10 Initializing a DIGSI 4 device, example

For information on using DIGSI 4 please refer to Chapter 4.3.6.

- Enter the **password** for **parameter set**.
The device display becomes blank.
After successful initialization the LEDs signal normal operation again and the default display reappears. The device-specific setting values are loaded back to the device in the state they were saved when the PC was started up. The device is ready for operation.

Additional Support

If these measures do not resolve the problem, please contact our hotline.

Our customer hotline needs the following information to assist you:

- The complete order number (MLFB) of the device,
- The serial number of the device,
- The version of the implemented firmware,
- The boot system version.

This information can be found by means of the operator control panel of the device or DIGSI 4. MLFB and factory number can also be read from the nameplate sticker on the device housing.

Operator Control Panel

- If the device is ready to operate, select
MAIN MENU > Parameters > Setup/Extras > MLFB/Version.

or

DIGSI 4

- In offline mode use the **File > Properties** menu to select the **Device** tab.

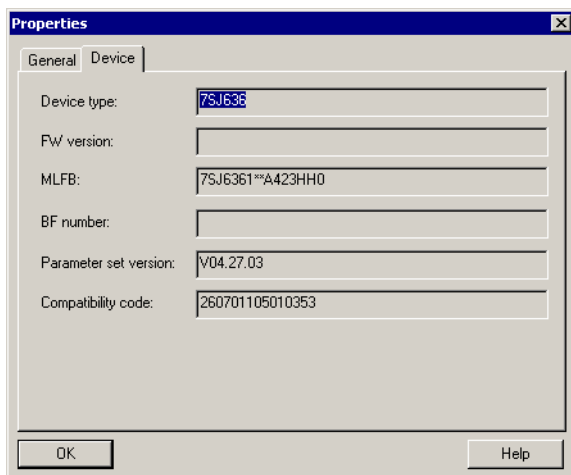

digsi631.gif

Fig. 8-11 DIGSI 4 object properties, example

8.6 Corrective Action / Repairs

8.6.1 Software Procedures

The software procedures during operation include:

- ❑ The initialization of the processor system, as described in Chapter 4.3.6 or
- ❑ Modification of the parameter setting, if for example you want to reduce the sensitivity of a monitoring function which is triggered sporadically during operation.

If the device cannot be successfully re-initialized, it should be removed from service and replaced with an operational device.

8.6.2 Hardware Procedures

Hardware modifications or repairs should be limited to the absolutely necessary. This includes in particular replacing the miniature fuse of the internal power supply.

Individual defective modules may only be replaced by experienced persons when absolutely necessary!

Under no circumstances may soldering work on the printed circuit boards be carried out!

Disassembling the Device

The device has to be disassembled in order to work on printed circuit boards. This is done as follows:

- Prepare the area of work. The following **tools** and **aids** are required:
 - A grounded mat suitable for protection against electrostatic discharges (ESD),
 - A screwdriver with a 5 to 6 mm tip,
 - A Philips screwdriver Size 1,
 - A 4.5 mm socket driver.
- Switch off all poles of the auxiliary voltage of the device at the circuit-breaker.

NOTICE

Electrostatic discharges over component terminals, conductor paths or pins must always be avoided by first touching grounded metal parts.

Do not withdraw or plug powered interface connections!



WARNING

Even after the supply voltage has been disconnected or the module has been removed, hazardous voltages may still be present in the device (capacitors can still be charged)!

- Pull all the plug connectors off from the device rear.
If there are optical-fiber connections, these have to be unscrewed and protected against ingress of dirt (not applicable for device variants for panel surface mounting).



WARNING

Laser radiation! Do not look into the ray, not even with optical devices.

Laser class 1 according to EN 60825-1.

- Unscrew the threaded screws of the D-subminiature female connector at location "A" on the device rear (not applicable for device variants for panel surface mounting).
- If the device has interfaces on the rear in addition to the interface at location "A", loosen the screws located diagonally (not applicable for device variants for panel surface mounting).
- Remove the covers on the front panel and loosen the screws which can then be accessed.
- Pull off the front panel and fold it carefully away to the side.
- Remove the plug connectors of the ribbon cable between the CPU board and the front panel. To disconnect the cable, push up on the top latch of the plug connector and push down on the bottom latch of the plug connector. Remove the plug connector of the ribbon cable between the CPU board and the I/O input/output modules.
- Remove the modules from the housing and place them on the prepared mat suitable for preventing ESD.
In the case of devices for panel surface mounting a certain amount of force is required in order to remove the CPU board due to the existing plug connector.

Replacing the Miniature Fuse

The location of the miniature fuse depends on the type of your SIPROTEC 4 device. At some devices they are positioned on the CPU board which also contains the power supply. This example is used to illustrate how the fuse is replaced.

Proceed as follows:

- Keep the replacement fuse 5 x 20 mm ready. Verify the correct rating, correct time lag (T) and the correct coding. This data is printed on the module (see Fig. 8-12).
The type of fuse depends on the auxiliary voltage. For example a fuse "T4H250V" in accordance with IEC 60127-2 is required for 24 to 48 V (see Table 8-1).
- Remove the defective fuse from the bracket (Fig. 8-12).

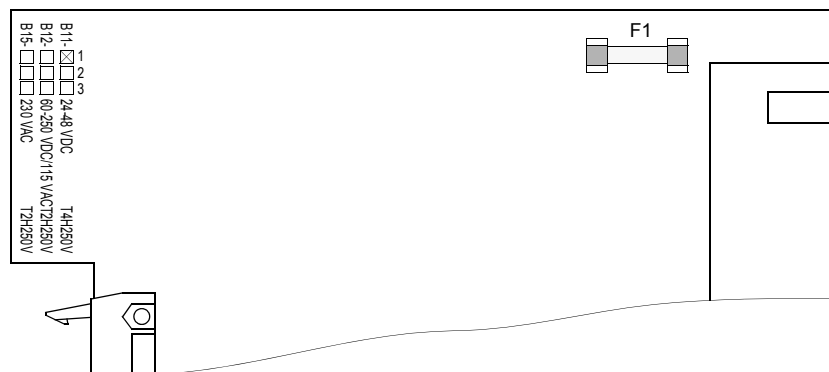

Fig. 8-12 Miniature fuse of the power supply of the CPU board

Table 8-1 Assignment of the miniature fuse to the device auxiliary voltage

SIPROTEC*** Variants	Rated auxiliary voltages	Fuse
-2****-****	24 V to 48 V	T4H250V
-4****-****	60 V to 125 V	T2H250V
-5****-****	110 V to 250 V, AC 115 V	T2H250V

- Insert the new fuse into the bracket.
- Plug the board carefully back into the housing.
The insertion location of the module is described in the chapter *Installation and Commissioning*.

Assembling the Device

Proceed as follows in order to reassemble the device:



NOTE

Proceed with utmost caution and do not use any force so that the connector pins are not bent! Ensure that the latches are latched in properly.

-
- Plug in the plug connector of the ribbon cable between the CPU board and the I/O input/output modules.
 - Plug the plug connector of the ribbon cable between the CPU board and the front panel of the device onto the plug connector of the front panel.
 - Replace the front panel and fasten it to the housing by means of the screws.
 - Replace the covers.
 - Fasten the rear interfaces again.
 - Plug all the connectors back onto the matching female connectors.
 - Screw any optical fiber connections back on.
When connecting an FC connector ensure that its lug is inserted properly into the socket groove and does not come out when the knurled nut is tightened. The knurled nut may only be tightened fingertight!

NOTICE

Laser radiation! Do not look into the ray, not even with optical devices.

Laser class 1 according to EN 60825-1.

The last three steps are not required for device variants for panel surface mounting.

- Switch the auxiliary voltage for the device back on.

If the green "RUN" LED does not light up, there is a fault or short-circuit in the internal power supply. In this case send the device back to the factory (see Chapter 8.7).

8.7 Return

Siemens strongly recommends that no further repairs be carried out on defective device or modules. Special electronic components are used which have to be treated in accordance with the guidelines for ESD (**E**lectrostatic **S**ensitive **D**evelopments). Special production techniques are required to avoid damaging the wave-soldered multi-layer board, the sensitive components, and the protective lacquer.

If a problem cannot be solved by the measures described in Sections 8.5 and 8.6, we recommend returning the **complete** device including front panel to the factory.

- The original transport packaging material should be used to return a device.
If alternative packaging is used, ensure that the protection against shock requirements specified in IEC 60255-21-1 Class 2 and IEC 60255-21-2 Class 1 are fulfilled.
- Before returning a device, read out and save all the configuration, function and control settings.
- Note any changes that were made to the jumper settings on the printed circuit boards.
- Please enclose an exact description of the problem and specify a contact person who can be contacted directly by our repair service should any questions arise.



NOTE

Repaired devices are returned from the factory with all jumpers on the printed circuit boards set in the original positions according to the ordering number. All configuration and setting parameters have the default setting.

Appendix

The appendix contains general operating instructions for DIGSI 4, configuration possibilities for information and detailed information on configuring modem connections.

Contents

A.1	Operating Instructions for DIGSI 4	472
A.2	Configuring Information Items - Overview	477
A.3	Plant Structure for Remote Operation Via Modem - Example	484
A.4	Wiring Diagrams for Connecting Cables	487
A.5	General Setting Hints for Modems	488

A.1 Operating Instructions for DIGSI 4

DIGSI 4 uses the window technique common for PC applications for the operator guidance. You are therefore in a familiar system environment.

While configuring or operating a SIPROTEC device with DIGSI 4, only the parameters relevant to the specified device are available.

The individual functions can be called up alternatively via the context menu (right mouse button), the menu bar or the toolbar.

Help System

The help system explains the individual functions and parameters, thus providing additional support. The help function can be accessed via the **Help** and **About** command button in the dialog boxes as well context-specifically via the **F1** key.

Context Menu

Operator guidance is often implemented in DIGSI 4 by means of context menus. These menus open the containers, start the applications, select the object properties, interlink the items of information, etc.

Proceed as follows:

- Move the mouse pointer to the object to be processed.
- Press the right mouse button. The current context menu is displayed.
- Click the function to be carried out.

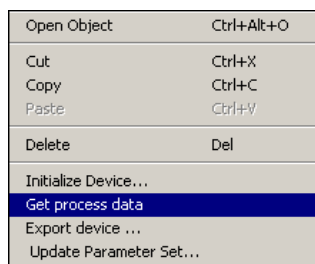

kontextme.gif

Fig. A-1 Example of a context menu



NOTE

Preferably carry out operating functions via the context menu.

Toolbars

Alternatively to the context menu and the menu bar the function can also be selected via the toolbar under DIGSI 4. The functions available depend on the DIGSI 4 components and the operating mode you are currently using.

Icons

Icons allow fast access to certain functions. The meaning of the icons is displayed as soon as you position the mouse pointer on a command button.

Status Bar

In the left-hand part of the status bar, help texts are displayed depending on the current operating situation and the position of the mouse pointer. The area is also used to display the progress of various operations. To this purpose bar segments are displayed whose size is proportional to the progress in time of the operation. To the right of that, you can see further information with the help of text abbreviations or icons.

- ❑ **Device type and version**
The device type (for example, 7SJ610) and the device version (for example, V 4.0) are displayed.
- ❑ **Operating mode**
The current operating mode is displayed in clear text with **OFFLINE** or **ONLINE**.
- ❑ **Serial port settings**
The current settings of the parameters for the serial port are displayed, such as the hardware interface (for example, COM1), transmission speed (for example, 34000 kb) and frame (for example, 0E1).
- ❑ **Test mode**
Two icons indicate whether test mode is active or inactive.
- ❑ **Acquisition blocking**
Two icons indicate whether the acquisition blocking is active or inactive.
- ❑ **Transmission blocking**
Two icons indicate whether the transmission blocking is active or inactive.
- ❑ **Number of spontaneous indications**
The number of spontaneous indications is displayed as a numeric value.
- ❑ **Keyboard settings**
In the right-hand part information about keyboard settings is displayed. **CL** means that the shift key has been locked on. **NUM** means that the numeric keypad has been activated. **OVR** indicates that overwrite mode has been activated.

Opening/Closing (Data) Containers

(Data) containers can be opened both from the navigation window and from the data window. Proceed as follows:

- Double-click in the navigation window on the container icon. The hierarchy levels (folders) of the container are shown in the navigation window and the contents are displayed in parallel in the data window.
- Double-click on the identifier of a container in the data window in order to open the container.

Drag-and-drop Function

The drag-and-drop function can be used to group objects of various data areas rapidly and reliably.

With drag-and-drop you can

- Copy data areas (for example from catalogs)
- Move data areas (for example when creating the plant topology)

Proceed as follows:

- Select an object.
- Position the mouse pointer on the selected object.
- Press the left mouse button and keep it pressed.
- Drag the mouse pointer to the corresponding position in the target window and release the mouse button.

In the target window a copy is inserted or the data area is moved to the selected point. An application-specific plausibility check is carried out in the process.

Copy Functions

Copy functions facilitate configuration and parameterization.

Define the template for your device parameterization and copy it by means of the **Copy** context menu.

The template parameterization is accepted completely during copying and adapted automatically - for the example the VD address is assigned again.

Tabs

Dialog boxes are divided into topic fields in order to facilitate the overview. The topic fields are called tabs.

- Click on a tab and change to the individual tabs of a dialog box.

Section

The content of the tab is divided into sections. In order to emphasize this structure optically, the individual sections are framed.

Check Boxes

Check boxes are used to activate or de-activate optional functions. The check boxes are displayed on the screen as a square box whose activation is indicated by a check mark.

- Click on an empty check box in order to activate the function.
- Click on a check box with check mark in order to de-activate the function.

Option Fields

The standard parameter settings can be extended or reduced by optional functions. The required input boxes (option boxes) are activated or de-activated optionally via check boxes.

Command Buttons

Command buttons are used to activate supplementary dialog boxes or functions. The command buttons have a self-explanatory text or have corresponding symbols and are activated by clicking. After the actions have been terminated, you return automatically to the start dialog box.

- Click on the command button (for example, DIGSI > Device).
The follow-up function is called up.

Dropdown Lists

Dropdown lists are linked to input fields in which only specified values can be assigned. Proceed as follows:

- Click with the mouse pointer on the input box.
The dropdown list folds down.
- Select the desired value. The selected value is included into the input box.

Dropdown Combo Box

A dropdown combo box is a combination of a simple input box and a dropdown list. Data can be entered manually or selected from a dropdown list.

Spin Box

In spin boxes you can enter values or increase/decrease the displayed values by defined steps:

- Click on the arrow up to increase the value.
- Click on the arrow down to decrease the value.

Selection Box

Selection boxes can be used to enter specified data into the individual cells of assignment tables. Proceed as follows:

- Move the mouse pointer to the table cell to be processed.
- Press the right mouse button. A context-sensitive list is displayed.
- Click on the desired value.

Catalogs

The **device catalog** contains all the SIPROTEC devices which you have selected during the installation or subsequent installation.

When the devices are inserted by drag-and-drop, the parameters of the corresponding database are imported into your project.

The **Report** window serves to display status messages from various areas. These messages are displayed in varying tabs depending on the contents of your information:

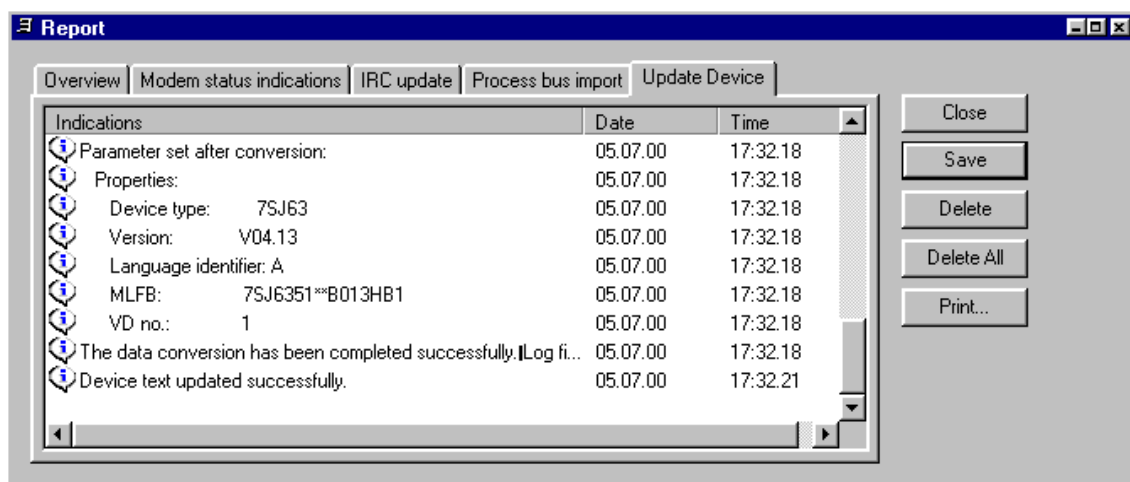

DIGSIMAN017

Fig. A-2 Report, example

**NOTE**

The **Report** window is an independent application. When you open the window, a button is created in the Windows taskbar. Clicking this button places the window on top. If you have closed the window manually, it automatically opens if an indication arises. It is not possible to open the window via a menu command.

A.2 Configuring Information Items - Overview

A.2.1 Indications

		SI_F	SI	DP, DP_I	OI_F	OUT	VI	IS_F	IS	IntDP, IntDP_I	BPxx	TxTap	ExSI_F	ExSI	ExDP, ExDP_I	ExBPxx
Source	Binary inputs	+	+	+	-	-	-	-	-	-	+	+	-	-	-	-
	Function key	-	-	-	-	-	-	+	+	-	-	-	-	-	-	-
	From IRC	-	+	+	-	+	-	-	+	+	+	+	-	+	+	+
	From CFC	+	+	+	+	+	+	+	+	+	-	-	-	-	-	-
	System interface IEC 60870-5-103	-	-	-	+R	+R	-	+	+	+	-	-	-	-	-	-
	System interface IEC 61850	1)	+R	+R	1)	+R	-R	1)	+R	+R	-R	1)	1)	+R	+R	-R
	System interface Profibus FMS	-	-	-	+R	+R	-	+	+	+	-	-	-	-	-	-
	System interface supplement	-	-	-	+R	+R	-	+	+	+	-	-	-	-	-	-
Destination	Binary outputs	+	+	-	+	+	+	+	+	-	-	-	+	+	-	-
	LED	+	+	-	+	+	+	+	+	-	-	-	+	+	-	-
	Operational event log buffer	+	+	+	+	+	+	+	+	+	+	+	+	+	+	+
	Sensitive ground fault indication	+	+	-	+	+	+	+	+	-	-	-	-	-	-	-
	Network fault buffer	+	+	-	+	+	+	+	+	-	-	-	-	-	-	-
	Warning messages	-	+	-	-	-	-	-	+	-	-	-	-	+	-	-
	System interface IEC 60870-5-103	+	+	+	+	+	+	+	+	+	-	-	+	+	+	-
	System interface IEC 61850	1)	+R	+R	1)	+R	+R	1)	+R	+R	-R	1)	1)	+R	+R	-R
	LDEExtended (IEC 61850)															
	System interface Profibus FMS	+	+	+	+	+	+	+	+	+	+	+	+	+	+	+
	System interface supplement	+	+	+	+	+	+	+	+	+	-	-	+	+	+	-
	To CFC	+	+	+	+	+	+	+	+	+	-	-	+	+	+	-
	To IRC	-	+	+	-	+	-	-	+	+	+	+	-	+	+	+
	Control display	+	+	+	+	+	+	+	+	+	-	+	+	+	+	-
Default display	+	+	+	+	+	+	+	+	+	-	+	+	+	+	-	
Control	-	+	+	-	-	-	+	+	+	+	+	-	+	+	+	

Properties indications	Mark in the fault record	+	+	-	+	+	-	+	+	-	-	-	-	-	-	-
	Filter time	+	+	+	-	-	-	-	-	-	+	+	-	-	-	-
	Filtering indication time before filtering	+	+	+	-	-	-	-	-	-	+	+	-	-	-	-
	Retrigger filter	+	+	+	-	-	-	-	-	-	+	+	-	-	-	-
	Filter intermediate position suppression	-	-	+	-	-	-	-	-	-	-	-	-	-	-	-
	Transformer encoding	-	-	-	-	-	-	-	-	-	-	+	-	-	-	-
	Transformer number of taps	-	-	-	-	-	-	-	-	-	-	+	-	-	-	-
	Transformer moving contact	-	-	-	-	-	-	-	-	-	-	+	-	-	-	-
	Transformer number of bits	-	-	-	-	-	-	-	-	-	-	+	-	-	-	-
	Transformer display offset	-	-	-	-	-	-	-	-	-	-	+	-	-	-	-
	Transformer tap interval	-	-	-	-	-	-	-	-	-	-	+	-	-	-	-
	Default selection reset	-	-	-	-	-	-	+	+	+	-	-	+	+	+	+
	Default selection restart	-	-	-	-	-	-	+	+	+	-	-	+	+	+	+
	Function type (IEC 60870-5-103)	+	+	+	+	+	+	+	+	+	-	-	+	+	+	-
	Information number (IEC 60870-5-103)	+	+	+	+	+	+	+	+	+	-	-	+	+	+	-
DU type (IEC 60870-5-103)	+	+	+	+	+	+	+	+	+	-	-	+	+	+	-	
<p>Is only displayed = "R" Can be parameterized = "+" Cannot be parameterized = "-" Can be parameterized for user objects, is only displayed for L0 objects = "+/R", "-/R" 1) Allocation to system interface as destination or (system interface as destination and system interface as source) allowed, allocation to system interface as source alone is not allowed. Can be parameterized for user objects, is only displayed for L0 objects</p>																

A.2.2 Commands

		C_xx	C_xx, InfArt TS	CF_xx	CF_xx, InfArt TS	ExC	ExCF
Source	From CFC	+	+	+	+	+	+
	From IRC	-	-	-	-	-	-
	System interface IEC 60870-5-103	+	-	+	+	+	+
	System interface IEC 61850						
	System interface Profibus FMS	+	+	+	+	+	+
	System interface supplement	+	-	+	+	+	+
Destination	Binary outputs	+	+	+	+	-	-
	Common contact relay	+	+	+	+	-	-
	Signal relay	+	+	+	+	-	-
	Operational event log buffer	+	+	-	-	+	-
	System interface IEC 60870-5-103	-	-	-	-	-	-
	System interface IEC 61850						
	LDEExtended (IEC 61850)						
	System interface Profibus FMS	-	-	-	-	-	-
	System interface supplement	-	-	-	-	-	-
	To CFC	+	+	+	+	+	+
	To IRC	-	-	-	-	-	-
	Control display	+	+	+	+	+	+
	Default display	+	+	+	+	+	+
	Control	+	+	+	+	+	+

Properties of commands	Base release object ON (partially blocked)	+	+	+	+	+	+
	Base release object OFF (partially block.)	+	+	+	+	+	+
	Release object ON	+	+	+	+	+	+
	Release object OFF	+	+	+	+	+	+
	Interlock identifier (8)	+	+	+	+	+	+
	Operating mode	+	+	+	+	-	-
	Output time	+	+	+	+	-	-
	Time delay	+	+	-	-	-	-
	Follow-up time	-	-	+	+	-	-
	Feedback message monitoring time	-	-	+	+	-	+
	Function type (IEC 60870-5-103)	+	+	+	+	+	+
	Information number (IEC 60870-5-103)	+	+	+	+	+	+
Is only displayed = "R" Can be parameterized = "+" Cannot be parameterized = "-"							

A.2.3 Measured Values

		LVU, InfArt MW	LVU, InfArt WM	LV, InfArt MW	LV, InfArt WM	MV	MVT	MVU	MC
Source	Analog inputs voltage	-		-		-	-	-	+
	Analog inputs current	-		-		-	-	-	+
	From CFC	+		+		-	-	+	-
	From IRC	+		+		+	-	+	-
	System interface IEC 60870-5-103	-		-		-	-	-	-
	System interface IEC 61850	X	-/R	X	-/R	X	X	X	-
	System interface Profibus FMS	+		+		-	-	-	-
	System interface supplement	+		+		-	-	-	-
Destination	Measured value window	R		R		-	-	+	-
	System interface IEC 60870-5-103	R		R		R	R	R	-
	System interface IEC 61850	X	+/R	X	+/R	X	X	X	-
	LDEExtended (IEC 61850)								-
	System interface Profibus FMS	+		+		+	+	+	-
	System interface supplement	+		+		+	+	+	-
	To CFC	+		+		+	-	-	-
	To IRC	+		+		+	-	+	-
	Control display	-		-		+	+	+	-
	Default display	-		-		+	+	+	-
Features	Default selection reset	+		+		-	-	-	-
	Default selection restart	+		+		-	-	-	-
	Factor	+		R		+	-	+	-
	Decimal places	+		R		+	-	+	-
	Dimension	+		R		+	-	+	-
	Min. setting value	+		R		-	-	-	-
	Max. setting value	+		R		-	-	-	-
<p>Is only displayed = "R" Can be parameterized = "+" Cannot be parameterized = "-" X: Allocation to system interface as destination or as source allowed, allocation to system interface as destination and as source not allowed. Can be parameterized for user objects, is only displayed for L0 objects</p>									

A.2.4 Metered Values

		PMV	MVMV	ExMV
Source	Binary inputs	+	-	-
	From IRC	-	-	+
	From CFC	-	-	+
	Reference measured value	-	R/+	-
	System interface IEC 60870-5-103	-	-	-
	System interface IEC 61850	X	X	-/R
	System interface Profibus FMS	-	-	-
	System interface supplement	-	-	-
Destination	Metered value window	+	+	-
	System interface IEC 60870-5-103	+	+	+
	System interface IEC 61850	X	X	+/R
	LDExtended (IEC 61850)			
	System interface Profibus FMS	+	+	+
	System interface supplement	+	+	+
	To IRC	-	-	+
	To CFC	+	+	+
	Control display	+	+	+
	Default display	+	+	+

Features	Restore type	+	+	-
	Power direction	R	+	-
	Factor	+	-	-
	Decimal places	+	-	-
	Dimension	+	-	-
	Pulse type	+	-	-
	External fault input	+	-	-
	Default selection reset	-	-	+
	Default selection restart	-	-	+
	Function type (IEC 608070-5-103)	+	+	+
	Information number (IEC 608070-5-103)	+	+	+
<p>Is only displayed = "R" Can be parameterized = "+" Cannot be parameterized = "-" Can be parameterized for user objects, is only displayed for L0-objects = "+/R", "-/R" X: Allocation to system interface as destination or as source allowed, allocation to system interface as destination and as source not allowed. Can be parameterized for user objects, is only displayed for L0 objects</p>				

A.3 Plant Structure for Remote Operation Via Modem - Example

If SIPROTEC protection devices are to be remote controlled via a dial modem, certain points have to be observed in the plant manager when creating the plant structure. The following passages describe a complete plant structure with all the settings for remote control via the dial modem MT2834.

Plant Structure

The user addresses (telephone numbers) of all the modems used in the project (for example, London region) are always saved directly in the project under **Phone Book**.

The modem settings for all the modems used in the project (office and plant modems) are always saved directly in the project under **Modems**.

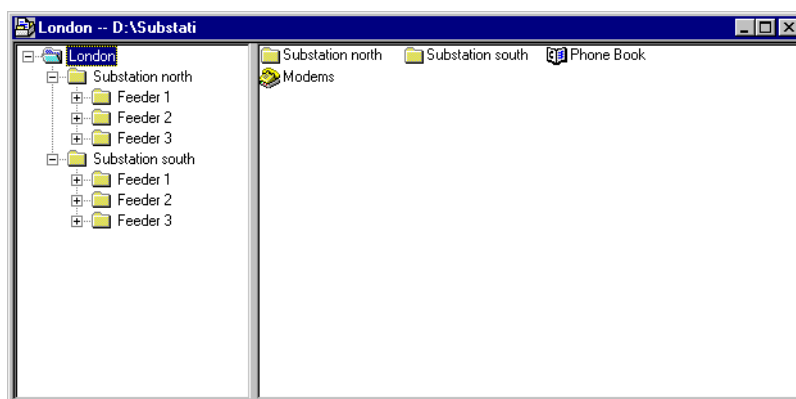

DIGSIKOM901.gif

Fig. A-3 Project structure with modems and phone book

A **modem connection** (for example modem connection North) specifies the modems used for dialing and can only be created in one folder, for example Substation North.

If there are further plant folders (for example, Substation South) in the same project, a **modem connection** (for example, modem connection South) can also be created there with the modems created under **Modems**.

The plant folder (for example Substation North) can in turn contain several feeder folders (for example Feeder 1, etc.) with the protection devices contained in it.

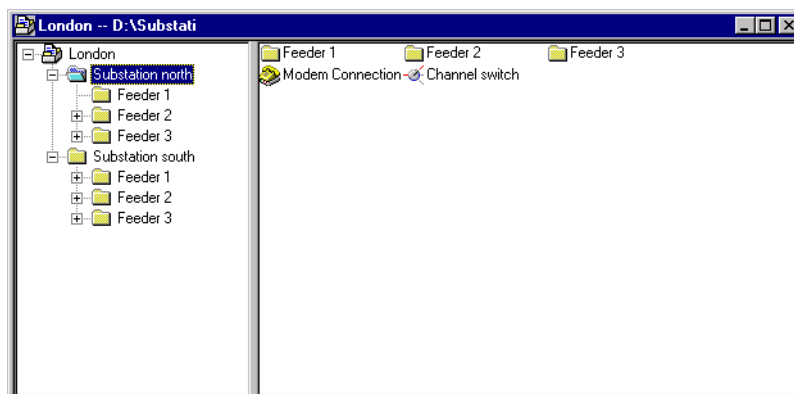

DIGSIKOM902.gif

Fig. A-4 Project structure with modems on various hierarchy levels



NOTE

If the plants (for example, the Substation North) are created individually in projects, the **Phone Book** and the **Modems** have to be created in each project.

If SIPROTEC 1/2/3 devices are to be operated in the plant via a channel switch (active mini star coupler), it is to be created (like the modem connection) in the plant folder (for example, Substation North). The plant structure in DIGSI 4 then also corresponds to the plant topology, thus considerably increasing the clarity by logical assignment of the plant components.



NOTE

If you want to operate a V2 device via a channel switch, the channel switch may only be connected to the PC interfaces COM1 - COM4.

Dialing Procedure

- Open the desired protection device (for example from the Substation North / Feeder 1) by double-clicking on it and select the operating mode **Online**, connection via **Modem**.

DIGSI 4 searches in the plant structure of the protection device upwards for a **modem connection** and finds it (modem connection North) in the plant folder (Substation North).

The connection is established with the settings of the modems specified in the modem connection North.

**NOTE**

The simplest method is to implement modem connections with the same modems.

Office Modem (Local Modem):

If the modem types and modem settings are the same for all the plants, the same office modem with telephone number can always be used in various modem connections.

If the office modem has to be initialized with different settings, because for example the data format of the plant modems (remote modem) differs, several office modems with different settings are created and assigned in the **Modem Connection** depending on the plant modem.

Plant Modem (Remote Modem):

A separate modem **has to be** created in the project under **Modems** for every plant since at least the assigned telephone number differs.

If the modem types and modem settings are the same for all the plants, several plant modems with the same settings and different telephone numbers are used in various modem connections.

If different modem types are used in the plants, the modems also have to be set correspondingly.

A.4 Wiring Diagrams for Connecting Cables

Figure A-5 shows a wiring diagram for a cable used for the connection between the modem and the service interface of the SIPROTEC 4 device. This cable **cannot** be purchased in this form from SIEMENS, since it is only to be used for test purposes. In order to protect against overvoltages an optical isolation should always be used for the connection from the modem to the devices.

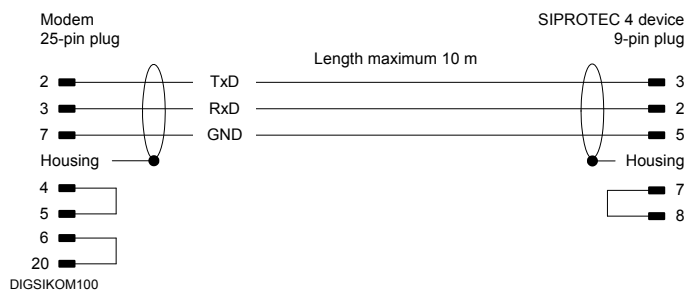

Fig. A-5 Wiring diagram for cable between modem and SIPROTEC 4 device

Figure A-6 shows a wiring diagram for the cable 7XV5100-4. It is used for direct connection between the serial interface of the computer and the front or service interface of the SIPROTEC 4 device.

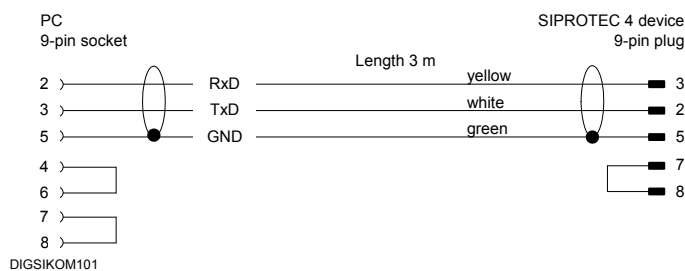

Fig. A-6 Wiring diagram for cable 7XV5100-4 between modem and SIPROTEC 4 device

A.5 General Setting Hints for Modems

Commissioning a modem line from the computer to the protection device may cause some problems. Therefore be sure to observe the following hints.

Parity Bit

DIGSI 4 communicates with SIPROTEC 4 devices by means of the protocol **IEC 60870-5-2**. This has a network layer and a transmission layer superimposed. The transmission layer is CRC-protected, thus offering a higher degree of transmission reliability than the lower IEC 60870-5-103 protocol. For modem connections this offers the advantage that the parity bit is not required.

Error Correction and Data Compression

For data transmission between modems, data compression and error correction are usually used nowadays. Both procedures cause data gaps in the data flow, which are not permitted in a message in accordance with IEC 60870-5-103. The first generation of IEC 60870-5-103 protection devices are correspondingly not gap-tolerant, so that data compression and error correction may not be activated in this case. A parameter makes allowances for the gap tolerance at newer devices and at all SIPROTEC 4 devices. You should activate error correction and data compression for these devices.

Handshake Mode (Flow Control)

Since many protection devices (for exceptions see below) cannot use handshake signals, the modem must be capable of receiving a minimum of 256 bytes. This corresponds to the maximum permissible message length. In some modems the buffer size is adapted to the internal block size of the data packet. It thus depends on the quality of the transmission line. This option therefore has to be de-activated. The service interface of the SIPROTEC 4 devices can be switched over to handshake mode by means of jumpers. You can thus use the handshake if you have connected only SIPROTEC 4 devices directly to a modem via the service interface.

Further Setting Hints

The following setting notes apply only if solely SIPROTEC 4 devices are connected to a modem. In case of mixed configuration observe the specific notes given in the manual for DIGSI V3.3, Chapters A.8.4 and A.8.5.

The transmission speed on the telephone line should not be limited so that the modems can set themselves to the highest possible speed. Data compression and error correction should be permitted. The parity, if it exists, should be de-activated.

If the plant modem requires the DTR signal in order to maintain a connection, it should be set - as far as possible - permanently by means of the DIP switch on the modem. Otherwise you must de-activate the signal via the initialization string (for example by using the command **AT&D0**).

Observe the following points for the settings at the PC and at the SIPROTEC 4 device:

- Maximum transmission speed in the WINDOWS configuration of the modem driver
- Baud rate of the used interface at the SIPROTEC 4 device
- Gap tolerance of the used interface at the SIPROTEC 4 device
- Data format for modem driver and for SIPROTEC 4 device

**NOTE**

As long as there is no communication and the gap tolerance ≥ 2.1 s, the SIPROTEC 4 device cyclically sends the command **ATE0Q1<CR>** with the set speed to so that a connected modem can synchronize to the baud rate. Therefore, a presetting of a fixed baud rate is no longer required at the remote modem provided that the modem used by you automatically recognizes the transfer rate at the serial interface.

However, this command is also a nuisance in some modems. If the modem receives this command while the connection is being established, it disconnects immediately, so that no connection can be established.

In this case the baud rate then has to be fixed and the echo switched off by using E0.

**NOTE**

For further setting notes and examples of applications refer to <http://www.siprotec.de> in the Internet. Open the **Download Area** and click on **Applications > Remote Control**.

Appendix

The appendix contains information on specific points for configuring indications and commands.

Contents

B.1	Indications	492
B.2	Commands	493

B.1 Indications

Indications can be device information on events and states which are to be made available via binary outputs, e.g. starting up of the processor system (event) or error in a device function (state). These are called **output indications**. Indications are also items of information from the plant to the device on events and states of the plant, for example tripping of a circuit breaker or the position of a switching device. These are called **input indications**.

The indications can be differentiated further depending on the type. Various types of indications are shown below schematically. Two binary inputs are required for a double indication. Their states are normally non-equivalent and are monitored by the device.

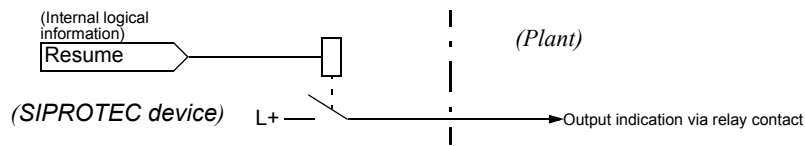
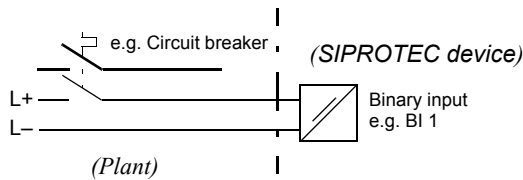
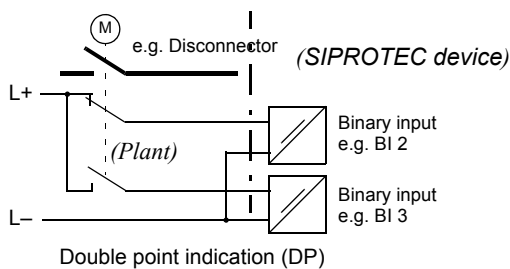

Fig. B-1 Output indication (OUT)



Single indication (SI)

Fig. B-2 Input indications SI



Double point indication (DP)

Fig. B-3 Input indication DP

B.2 Commands

Commands are output indications which are designed specifically to output control signals to the plant switching devices.

- ❑ Specify for each switching device whether it is to be switched with 1, 1^{1/2}, 2, ... poles, with single or double command, with or without feedback. The required number of items of information to be processed is determined from this information and the command type is specified.
- ❑ Assign the resulting requirements to the binary inputs and outputs existing in the SIPROTEC device. Observe the following points:
 - Indications and commands belonging to one switching device must have consecutive binary inputs and outputs assigned to them in the device.
 - The common contacting of binary inputs and outputs in the SIPROTEC device can result in restrictions.

When you have defined the type of a command, DIGSI 4 reserves a corresponding number of binary outputs of the device. The corresponding binary outputs are numbered consecutively. This point has to be observed when assigning the binary outputs to the control functions.

For double commands use DIGSI 4 to specify the respective first binary output. The subsequent ones are added automatically by DIGSI 4.

In the case of commands with feedback DIGSI 4 automatically reserves a line for the feedback of the switching device in the configuration matrix.

Here the following applies: **The OFF feedback must always be positioned before the ON feedback.**

The following figures show examples of timing diagrams, control circuits, as well as the sequence of the relay assignments for common command types. The following abbreviations are used:

- CON Relay contact ON
- COFF Relay contact OFF
- CCC Relay contact common contact
- CCCC Relay contact central common contact
- L+; L- Control voltage

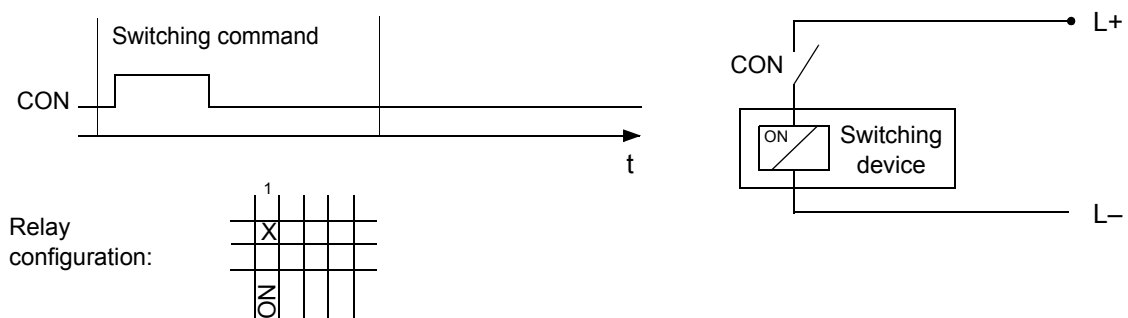

Fig. B-4 1-pole single command

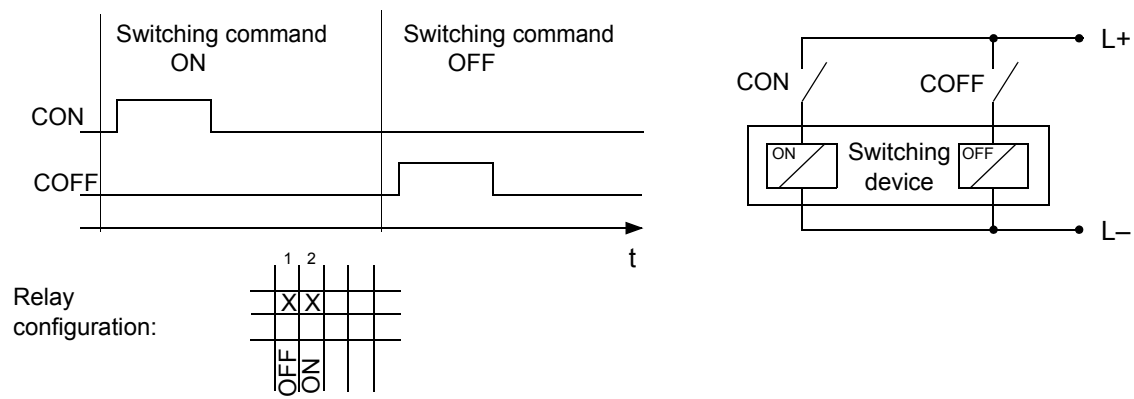

Fig. B-5 1-pole double command

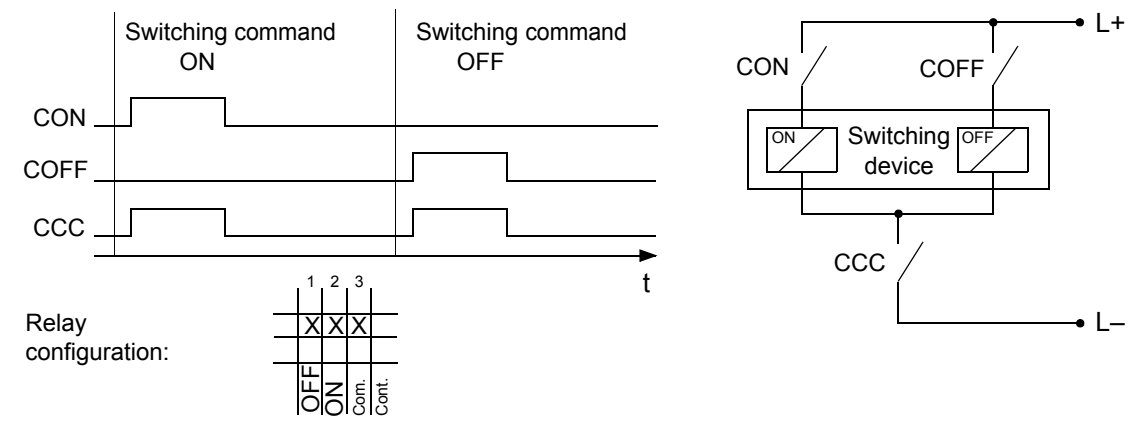

Fig. B-6 1 1/2-pole double command

In Figure B-7 the central common contact has several switching devices assigned to it in contrast to all other binary outputs. For safety reasons simultaneous switching of several switching devices is prevented by interlocking.

During command output for a switching device the common contact relay automatically used the properties of the binary output to be controlled, meaning that it is not configured separately. The output type is 1-pole.

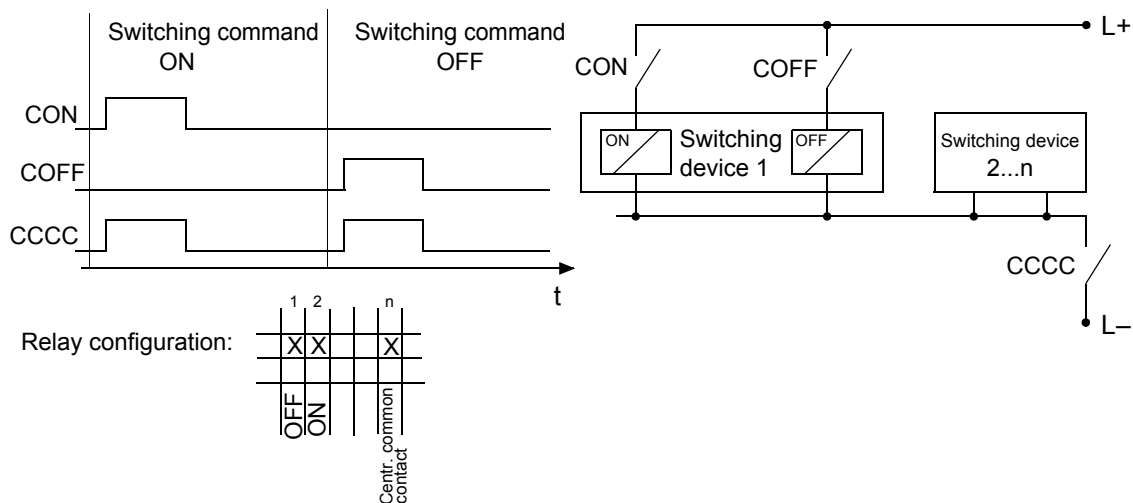

Fig. B-7 1-pole double command with central common contact

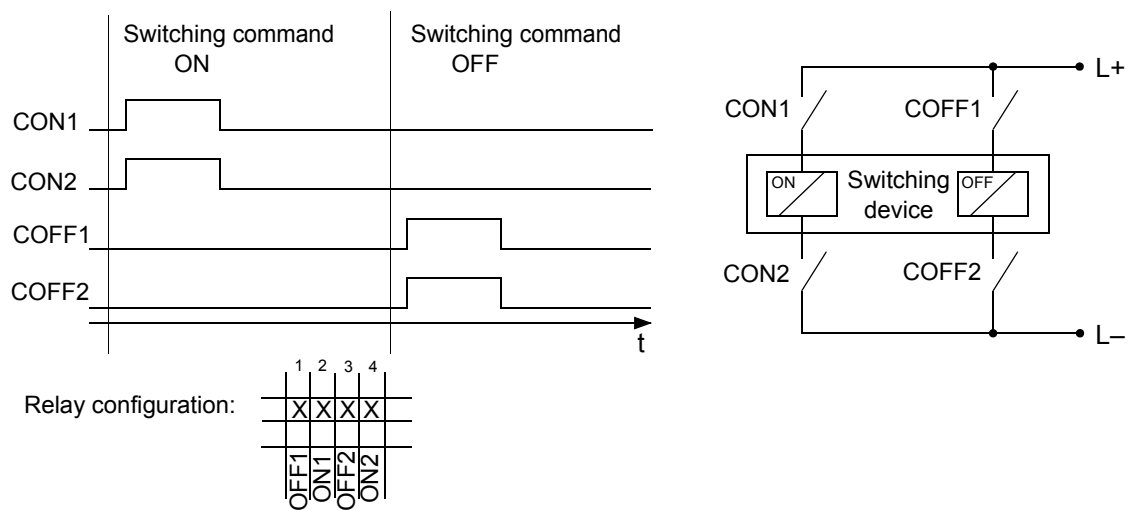

Fig. B-8 2-pole double command (via 4 relays with one contact each)

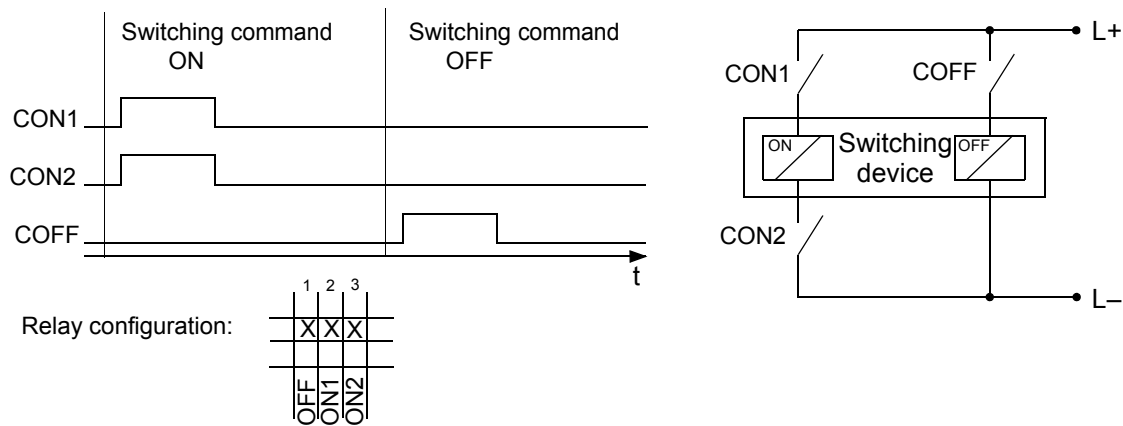

Fig. B-9 Circuited 1-pole OFF, 2-pole ON (with 3 relays)

In the motor control in Figure B-10 corresponding circuiting can be used to implement:

- Anti-clockwise via the switching command ON
- Clockwise via the switching command OFF
- And OFF in the idle state

The power relays with two NO contacts each used to this purpose are interlocked, so that only **one** relay can pick up at any time.

The following points are to be observed during configuration if power relays are to be used for a motor-controlled **three-position disconnecter**: The same output relays are controlled by two separate commands for the disconnecter and the ground-electrode functions. Since the two end positions are to be reached from the common OFF position by means of different directions of rotation of the drive motor, one of the two commands has to be negated. The command types **BR_D2** and **BR_D2N** can thus, for example, be used for this application.

The **2-pole circuiting with one channel** via 2 relays with one contact pair each is only possible with restrictions. To this purpose two of the power relays designed for motor controls are used in the device versions with power relay (Figures B-11 and B-12). Observe the internal common contacting. For further information please refer to the overview charts in the appendix of the device manual.

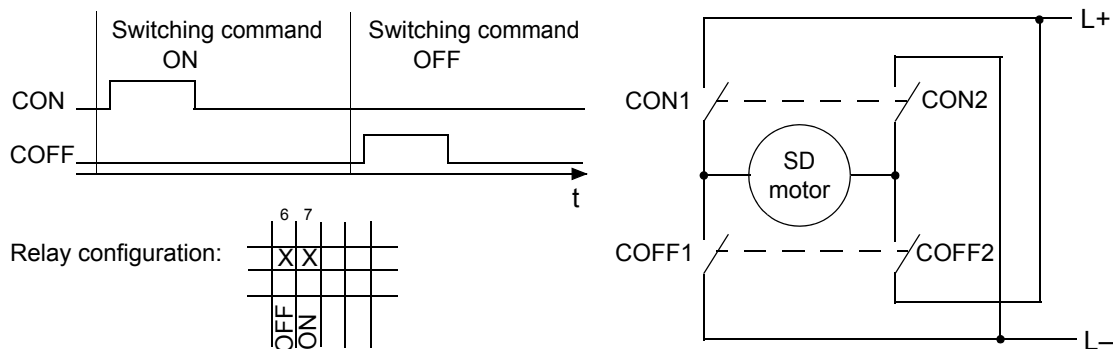

Fig. B-10 Circuited for motor control (anti-clockwise/clockwise), via two power relays with two contacts each

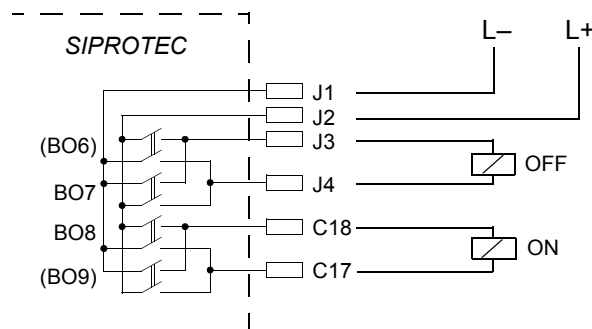
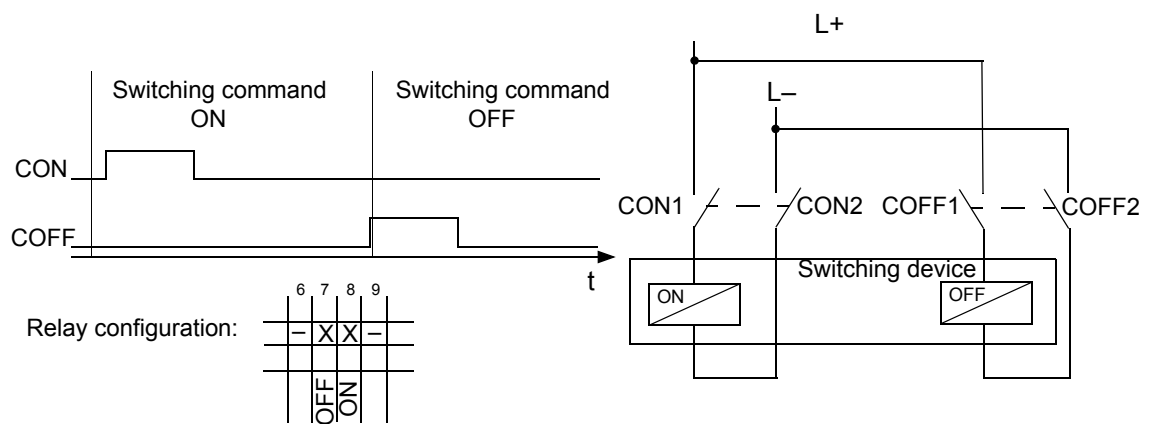

Fig. B-11 Section from the overview diagram of the variants with the power relays BO6 to BO9 (as an example) and their circuiting in accordance with Figure B-12



The relays identified by - may not be circuited elsewhere!

Fig. B-12 Circuiting 2-pole, with one channel via two power relays with two contacts each (by configuring "Double command, 1-pole"), example

Literature

- /1/ SIPROTEC DIGSI 4, Start Up
E50417-G1176-C152
- /2/ DIGSI CFC, Manual
E50417-H1176-C098
- /3/ SIPROTEC SIGRA 4, Manual
E50417-H1176-C070
- /4/ Ethernet & IEC 61850, Start UP
E50417-F1176-C324
- /5/ Ethernet & IEC 61850, Concepts, Implementation, Commissioning
E50417-F1176-C361

Glossary

Battery

The buffer battery ensures that specified data areas, flags, timers and counters are retained retentively.

Bay controllers

Bay controllers are devices with control and monitoring functions without protective functions.

Bit pattern indication

Bit pattern indication is a processing function by means of which items of digital process information applying across several inputs can be detected together in parallel and processed further. The bit pattern length can be specified as 1, 2, 3 or 4 bytes.

BP_xx

> Bit pattern indication (bit string of x bits),
x designates the length in bits (8, 16, 24 or 32 bits).

C_xx

Command without feedback

CF_xx

Command with feedback

CFC

Continuous Function Chart. CFC is a graphics editor with which a program can be created and configured by using ready-made blocks.

CFC blocks

Blocks are parts of the user program delimited by their function, their structure or their purpose.

Chatter suppression

A rapidly intermittent input (for example, due to a relay contact fault) is switched off after a configurable monitoring time and can thus not generate any further signal changes. The function prevents overloading of the system when a fault arises.

Cleaning up

Frequent addition and deletion of objects gives rise to memory areas that can no longer be used. By cleaning up projects, you can release these memory areas again. However, a clean up also reassigns the VD addresses. The consequence of that is that all SIPROTEC 4 devices have to be reinitialized.

Combination devices

Combination devices are bay devices with protection functions and a control display.

Combination matrix

Up to 16 compatible SIPROTEC 4 devices can communicate with one another in an Inter Relay Communication combination (IRC combination). Which device exchanges which information is defined with the help of the combination matrix.

Communication branch

A communication branch corresponds to the configuration of 1 to n users which communicate by means of a common bus.

Communication reference CR

The communication reference describes the type and version of a station in communication by PROFIBUS FMS.

Component view

In addition to a topological view, SIMATIC Manager offers you a component view. The component view does not offer any overview of the hierarchy of a project. It does, however, provide an overview of all the SIPROTEC 4 devices within a project.

COMTRADE

Common Format for Transient Data Exchange, format for fault records.

Container

General term summarizing objects comprising further objects. The object **Folder** is an example of such a container.

Control display

The display which is displayed on devices with a large (graphic) display after you have pressed the control key is called the control display. It contains the switchgear that can be controlled in the feeder with status display. It is used to perform switching operations. Defining this diagram is part of the configuration.

Data pane

The right-hand area of the project window displays the contents of the area selected in the > navigation window, for example indications, measured values, etc. of the information lists or the function selection for the device configuration.

DCF77

The extremely precise official time is determined in Germany by the "Physikalisch-Technischen-Bundesanstalt PTB" in Braunschweig. The atomic clock unit of the PTB transmits this time via the long-wave time-signal transmitter in Mainflingen near Frankfurt/Main. The emitted time signal can be received within a radius of approx. 1,500 km from Frankfurt/Main.

Device container

In the Component View, all SIPROTEC 4 devices are assigned to an object of the type **Device container**. This object is also a special object of the DIGSI 4 Manager. However, since there is no component view in DIGSI 4 Manager, this object only becomes visible in conjunction with STEP 7.

Double command

Double commands are process outputs which indicate 4 process states at 2 outputs: 2 defined (for example ON/OFF) and 2 undefined states (for example intermediate positions)

Double point indication

Double point indications are items of process information which indicate 4 process states at 2 inputs: 2 defined (for example ON/OFF) and 2 undefined states (for example intermediate positions).

DP

> Double point indication

DP_I

> Double point indication with intermediate position 00

Drag-and-drop

Copying, moving and linking function, used at graphics user interfaces. Objects are selected with the mouse, held and moved from one data area to another.

Earth

The conductive earth whose electric potential can be set equal to zero at every point.

In the area of ground electrodes the earth can have a potential deviating from zero. The term "Ground reference plane" is often used for this state.

Earthing

Earthing means that a conductive part is connected via an earthing system to the > earth.

Earthing

Earthing is the total of all means and measures used for earthing.

Electromagnetic compatibility

Electromagnetic compatibility (EMC) is the ability of an electrical apparatus to function fault-free in a specified environment without influencing the environment unduly.

EMC

> Electromagnetic compatibility

ESD protection

ESD protection is the total of all the means and measures used to protect electrostatic sensitive devices.

ExBPxx

External bit pattern indication via an ETHERNET connection, device-specific > Bit pattern indication

ExC

External command without feedback via an ETHERNET connection, device-specific

ExCF

External command with feedback via an ETHERNET connection, device-specific

ExDP

External double point indication via an ETHERNET connection, device-specific > Double point indication

ExDP_I

External double point indication via an ETHERNET connection intermediate position 00, device-specific, > Double point indication

ExMV

External metered value via an ETHERNET connection, device-specific

ExSI

External single point indication via an ETHERNET connection, device-specific > Single point indication

ExSI_F

External single point indication fleeting via an ETHERNET connection, device-specific, > Transient information, > Single point indication

Field devices

Generic term for all devices assigned to the field level: protection devices, combined bay protection and control units, bay controllers.

Floating

Without electrical connection to the > earth.

FMS Communication branch

Within an FMS communication branch (FMS = **F**ieldbus **M**essage **S**pecification) the users communicate on the basis of the PROFIBUS FMS protocol via a PROFIBUS FMS network.

Folder

This object type is used to create the hierarchical structure of a project.

General interrogation (GI)

During the system start-up the state of all the process inputs, of the status and of the fault image is sampled. This information is used to update the system-end process image. The current process state can also be sampled after a data loss by means of a GI.

GPS

Satellites with atomic clocks on board orbit the earth twice a day in different parts in approx. 20,000 km. They transmit signals which also contain the GPS universal time. The GPS receiver determines its own position from the signals received. From its position it can derive the running time of a satellite and thus correct the transmitted GPS universal time.

Ground

The conductive ground whose electric potential can be set equal to zero at every point.

In the area of ground electrodes the earth can have a potential deviating from zero. The term "Ground reference plane" is often used for this state.

Grounding

Grounding means that a conductive part is connected via an grounding system to the > Ground.

Hierarchy level

Within a structure with higher-level and lower-level objects a hierarchy level is a container of equivalent objects.

HV field description

The HV project description file contains details of fields which exist in a ModPara-project. The actual field information of each field is memorized in a HV field description file. Within the HV project description file, each field is allocated such a HV field description file by a reference to the file name.

HV project description

All the data is exported once the configuration and parameterization of PCUs and sub-modules using ModPara has been completed. This data is split up into several files. One file contains details about the fundamental project structure. This also includes, for example, information detailing which fields exist in this project. This file is called a HV project description file.

ID

Internal double pointindication > double point indication

ID_S

Internal double pointindication intermediate position 00 > double point indication

IEC

International Electrotechnical Commission

IEC address

Within an IEC bus a unique IEC address has to be assigned to each SIPROTEC 4 device. A total of 254 IEC addresses are available for each IEC bus.

IEC communication branch

Within an IEC communication branch the users communicate on the basis of the IEC870-5-2 protocol via an IEC bus.

Initialization string

An initialization string comprises a range of modem-specific commands. These are transmitted to the modem within the framework of modem initialization. The commands can, for example, force specific settings for the modem.

IRC combination

Inter Relay Communication, IRC, is used for directly exchanging process information between SIPROTEC 4 devices. You require an object of type **IRC combination** to configure an Inter Relay Communication. Each user of the combination and all the necessary communication parameters are defined in this object. The type and scope of the information exchanged among the users is also stored in this object.

IRIG-B

Time signal code of the Inter-Range Instrumentation Group

IS

Internal single point indication > single point indication

IS_F

Internal indication fleeting > transient information > single point indication

ISO 9001

The ISO 9000 *ff* range of standards defines measures used to ensure the quality of a product from the development stage to the manufacturing stage.

Link address

The link address indicates the address of a V3/V2-device.

List view

The right pane of the project window displays the names and icons of objects which represent the contents of a container selected in the tree view. Because they are displayed in the form of a list, this area is called the list view.

LV

Limit value

LVU

Limit value, user-defined

Master

Masters may send data to other users and request data from other users. DIGSI 4 operates as a master.

Metered value

Metered values are a processing function with which the total number of discrete similar events (counting pulses) is determined for a period, usually as an integrated value. In power supply companies the electrical work is usually recorded as a metered value (energy purchase/supply, energy transportation).

MLFB number

MLFB is the abbreviation of the term **Maschinenlesbare Fabrikatebezeichnung**. This is the equivalent of an order number. The type and version of a SIPROTEC 4 device are coded in the order number.

Modem connection

This object type contains information on both partners of a modem connection, the local modem and the remote modem.

Modem profile

A modem profile consists of the name of the profile, a modem driver and may also comprise several initialization commands and a user address. You can create several modem profiles for one physical modem. To do so you need to link various initialization commands or user addresses to a modem driver and its properties and save them under different names.

Modems

Modem profiles for a modem connection are saved in this object type.

MV

Measured value

MVMV

Metered value which is formed from the measured value

MVT

Measured value with time

MVU

Measured value, user-defined

Navigation pane

Left pane of the project window which displays the names and symbols of all containers of a project in the form of a folder tree.

Object

Each element of a project structure is called an object in DIGSI 4.

Object properties

Each object has properties. These might be general properties that are common to several objects. An object can also have specific properties.

Offline

In **Offline** mode a link with the SIPROTEC 4 device is not necessary. You work with data which are stored in files.

OI_F

Output indication fleeting > transient information

Online

If you are working in the **Online** operating mode, a physical connection has been established to a SIPROTEC 4 device. This link can be implemented as a direct connection, as a modem connection or as a PROFIBUS FMS connection.

OUT

Output indication

Parameterization

General term for all adjustments made to the device. Parameterization jobs are executed by means of DIGSI 4 or, in some cases, directly on the device.

Parameter set

The parameter set is the set of all parameters that can be set for a SIPROTEC 4 device.

Phone Book

User addresses for a modem connection are saved in this object type.

PMV

Pulse metered value

PROFIBUS

PROcess **FI**eld **BUS**, the German process and Field bus standard specified within the framework of EN 50170, volume 2, PROFIBUS. It defines the functional, electrical, and mechanical properties for a bit-serial field bus.

PROFIBUS address

Within a PROFIBUS network a unique PROFIBUS address has to be assigned to each SIPROTEC 4 device. A total of 254 PROFIBUS addresses are available for each PROFIBUS network.

Project

Content-wise, a project is the image of a real power supply system. *Graphically*, a project is represented by a number of objects which are integrated in a hierarchical structure. *Physically*, a project consists of a series of folders and files containing project data.

Protection devices

All devices with a protective function and no control display.

RIO file

Relay data Interchange format by Omicron.

RSxxx-interface

Serial interfaces RS232, RS422/485

Service interface

Serial interface on the devices for connecting DIGSI 4 (for example, via modem).

SI

> Single point indication

SI_F

> Single-point indication fleeting > transient information, > single point indication

SICAM SAS

Modularly structured station control system, based on the substation controller > SICAM SC and the SICAM WinCC operator control and monitoring system.

SICAM SC

Substation Controller. Modularly structured substation control system, based on the SIMATIC M7 automation system.

SICAM WinCC

The SICAM WinCC operator control and monitoring system displays the state of your network graphically, visualizes alarms, interrupts and indications, archives the network data, offers the possibility of intervening manually in the process and manages the system rights of the individual employee.

Single command

Single commands are process outputs which indicate 2 process states (for example, ON/OFF) at one output.

Single point indication

Single indications are items of process information which indicate 2 process states (for example, ON/OFF) at one output.

SIPROTEC

The registered trademark SIPROTEC is used for devices implemented on system base V4.

SIPROTEC 4 device

This object type represents a real SIPROTEC 4 device with all the setting values and process data it contains.

SIPROTEC 4 Variants

This object type represents a variant of an object of type **SIPROTEC 4 device**. The device data of this variant may well differ from the device data of the source object. However, all variants derived from the source object have the same VD address as the source object. For this reason they always correspond to the same real SIPROTEC 4 device as the source object. Objects of type **SIPROTEC 4 variant** have a variety of uses, such as documenting different operating states when entering parameter settings of a SIPROTEC 4 device.

Slave

A slave may only exchange data with a master after being prompted to do so by the master. SIPROTEC 4 devices operate as slaves.

System interface

Serial interface on the devices for connecting to a control system via IEC or PROFIBUS.

Time stamp

Time stamp is the assignment of the real time to a process event.

Topological view

DIGSI 4 Manager always displays a project in the topological view. This shows the hierarchical structure of a project with all available objects.

Transformer tap indication

Transformer tap indication is a processing function on the DI by means of which the steps of the transformer adjustment can be detected together in parallel and processed further.

Transient information

A transient information is a brief transient > single-point indication at which only the coming of the process signal is detected and processed immediately.

Tree view

The left pane of the project window displays the names and symbols of all containers of a project in the form of a folder tree. This area is called the tree view.

TxTap

> Transformer tap indication

User address

A user address comprises the name of the station, the national code, the area code and the user-specific phone number.

Users

Up to 16 compatible SIPROTEC 4 devices can communicate with one another in an Inter Relay Communication combination. The individual participating devices are called users.

Value indication

Value indications are > single point indications that transfer a value in addition to the actual indication (example: "fault locator": Here the distance of the fault locations is transferred in addition to the statement error "Yes/NO".)

VD

A VD (**V**irtual **D**evice) includes all communication objects and their properties and states that are used by a communication user through services. A VD can be a physical device, a module of a device or a software module.

VD address

The VD address is assigned automatically by DIGSI 4 Manager. It exists only once in the entire project and thus serves to identify unambiguously a real SIPROTEC 4 device. The VD address assigned by DIGSI 4 Manager must be transferred to the SIPROTEC 4 device in order to allow communication with DIGSI 4 Device Configuration.

VFD

A VFD (**V**irtual **F**ield **D**evice) includes all communication objects as well as their properties and states, used via services by a communication partner.

Index

A

- Absolute time 227
- Access authorizations 28, 135
- Advanced 295
- Allocation 167
- Analog inputs 185
- Analog modems 383
- Analog output 67
- Analogue input 181
- Aquisition blocking 473
- Archive
 - Across diskettes 103
 - Create new 106
 - Selecting 106
- Archive directories 104
- Archive program
 - Configuring 102
 - Selecting 101, 102
- Archiving 105
- Archiving automatically 106
- Archiving options 103
- ASCII/ELCAD 151
- Assigning text
 - User Text 255

B

- Baud rate 379, 380
- Bay controllers 501
- Binary input 175, 181, 183, 283
- Binary output 182, 186
- Binary outputs for switching devices 187
- Blocking by protection 220
- Buffer 182, 194
- Bus address 395

C

- Catalogs 475
- Central/ remote control 382
- CFC 26, 32, 167, 181, 182, 200
 - Inserting a CFC chart 233
- CFC charts
 - exporting 152
- Characteristic
 - Changing 299
- Characteristics 297
- Chatter check time 229
- Chatter checks 229
- Chatter idle time 229
- Chatter test time 229
- Check time 229
- Circuit breaker test function 348
- Cleaning up 118, 509
- Close 120
- Column 95

- COM port 379
- COM PROFIBUS 392
- Combination devices 502
- Combination matrix 502
- command 32
- Commissioning 24
- Common contact 187
- Communication 19
 - Communication reference CR 502
 - IEC address 505
 - Initializing a SIPROTEC 4 device 376
 - Modem connection 507
 - Modems 507
 - Phone book 508
 - Plug & Play 372
 - Service interface 509
 - System interface 510
 - User address 510
 - Working online 371
- Communication branch 511
- Communication Modules 171
- Communication reference CR 404, 502
- Communications modules 171
- Comparison 128
- Component view 108, 502
- Configuration 26
- Configuration matrix 24
- conformity 3
- Connecting cable 487
- Connections for low-level signal converter 69
- Connectors 57
- Container 86, 474, 501
- Context menu 472
- Control 182, 196, 353
 - Switching authority at local control 220, 221
 - Switching authority at remote control 220
 - Switching direction 221
- Control display 167, 182, 192, 233, 502
 - Creating an empty control display 236
 - Drawn and configured 265
- Control indications 365
- Control of switchgear 352
- Control operations 29
- Controlling 32
- Controlling device functions 337
- Conversion factor 218
- Copy 175, 323
 - Area symbol 274
- Copy functions 474
- Corrective action / repairs 465
- Covering caps 55
- CP 5412 (A2) 391, 414
- Creating
 - Device circuit breaker 276

- Empty control display 236
- Empty default display 234
- New device 276, 277
- Creating a Device 276
- Creating a new symbol 268
- Creating an empty control display 236
- Creating an empty default display 234
- Creating an empty symbol 269
- Cubicle installation 38
- Current connections 52
- Current input 181
- D**
- Date 117
- DCF77 21
- Decimal places 218
- Declaration of Conformity 3
- Default display 167, 182, 192, 238
 - Creating an empty default display 234
 - Delete 235
 - Displaying in normal size 262
 - Drawn and configured 238
 - Opening 239
 - Printing out 263
 - Saving 264
 - Saving an empty default display 235
 - With positioned devices 247
 - With positioned symbols 256
- Default display with topology 242
- Delay 221
- Delete 323
 - All 246
 - All symbol 274
 - Area symbol 273
 - Line symbols 245
 - Points in the symbol editor 271
 - Points symbol 273
 - Positioned device 252
 - Positioned symbol 258
 - Positioned text 259
 - Range 246
 - Standard default display 235
 - Symbol 275
- Deleting a standard default display 235
- Deleting all 246
- Deleting all symbol 274
- Deleting the indication memory 318
- Destination 182
- Detached operator control panel 46
- Device 168, 291
- Device catalog 156
- Device configuration 375
- Device container 505
- Device data
 - Configuring a SIPROTEC 4 device 371
 - Exporting device data 142
 - Importing device data 144
 - Installing device updates 153
- Device designation 277
- Device font
 - Displaying 236
- Device inputs and outputs 458
- Device matrix
 - Colouring 182
 - Horizontal structure 181
 - Reduction of the display scope 202
 - Vertical structure 182
- Device texts 159
- Device type 473
 - Updating device types 155
- Device variant 121
- Device width 277
- Devices
 - Assigning a state symbol 278
 - Creating a circuit breaker 276
 - Creating anew 276, 277
 - Deleting a positioned device 252
 - Highlighting 260
 - Linking to information 250
 - Making operator-controllable 266
 - Moving a positioned device 252
 - Moving while inserting 249
 - Open object 278
 - Positioned in default display 247
 - Positioning 248
 - Relinking 252
 - Specifying a device designation 277
 - Specifying properties 278
 - Specifying the device width 277
 - Specifying the first operator-controllable 267
 - Specifying the type 277
- DIGSI 4 Remote 368
- DIGSI key 140
- DIGSI operating tree 115
- DIGSI4 VD address 370
- Dimension 218
- Disassembly of the device 465
- Display
 - Status bar 234
 - Toolbars 234
 - Tooltips 234
- Display offset 215
- Display text 181
- Displaying the switch position 353
- Displaying toolbars 234
- Displaying Tooltips 234
- DNP 3.0 368, 439
- DNP 3.00 19, 21
- DNP3.0 282
- Double activation blockage 220
- Drag-and-drop 474
- Drawing
 - Circle symbol 272
 - Drawing a symbol freehand 271
 - Drawing mode symbol 271
 - Ellipse symbol 272
 - Filling a surface symbol 273
 - Horizontal line 244

- Intersections 245
 - Line symbol 271
 - Rectangle symbol 271
 - Tools symbol 271
 - Vertical lines 242
 - Drawing a circle 272
 - Drawing an ellipse 272
 - Drawing freehand 271
 - Drawing horizontal lines 244
 - Drawing intersections 245
 - Drawing mode
 - Drawing symbol 271
 - Drawing vertical lines 242
 - Drawn and configured
 - Control display 265
 - Default display 238
 - Dropdown
 - Combo box 475
 - lists 475
 - DU type 191, 223
- E**
- Earth fault indications 314
 - Editing
 - Header 240
 - ELCAD 150
 - Electrical check 74
 - Empty default display
 - Saving 235
 - Encoding 215
 - Energy flow direction 217
 - Energy meter 325, 328
 - Establishing a connection 114
 - Ethernet 19, 21
 - Ethernet connection according to IEC 61850 19, 21
 - Ethernet modems 383
 - Ethernet NTP 283
 - Exporting 142, 148, 149, 293
 - CFC charts 152
 - Configurations and protection parameters 150
 - Fault record data 149
 - Setting protection functions 148
 - System interface 151
 - Extraction tool 60
- F**
- Fault event buffer 119
 - Fault indications 311
 - Fault recording 168, 291
 - Fault recording data 333
 - Fault records 31, 214
 - Fault value recordings 31
 - Feedback monitoring 221
 - Field devices 504
 - Filling a surface 273
 - Filter criteria 202
 - Filter time 214
 - Filtering 96
 - First startup 213
 - FMS communication branch 504
 - FMS Slave 396
 - Folder 505
 - Frame 372, 376, 379, 380
 - Front panel fixture 36
 - Function key 181, 185
 - Function type 191, 223
 - Functional scope 26, 167, 172, 230
 - Functions 177, 292
 - Selecting functions 178, 293
- G**
- General interrogation 316
 - Group
 - Deleting a group 211
 - Inserting a group 209
 - Renaming a group 210
 - Group Switchover of the Function Parameters 343
- H**
- Header
 - Editing 240
 - Text input box 241
 - Help system 24, 472
 - Hiding
 - Grid 260
 - Hiding the grid 260
 - Highlighting
 - Devices 260
 - Housing 38, 42
 - HV field description 505
 - HV project description 505
- I**
- Icons 473
 - Idle time 229
 - IEC 19, 21, 282
 - IEC 60 870-5-103 21, 282
 - IEC 60870-5-103 19, 21, 282
 - IEC 61850 19, 21
 - IEC 61850 (Ethernet) 282
 - IEC address 371, 379, 505
 - IEC communication branch 506
 - IEC link address 371, 380
 - Importing 144
 - Indication elements 35
 - Indications 30, 492
 - Initiator category 308
 - Transmission cause 308
 - Info 187
 - Information 181
 - Deleting information 211
 - Inserting an information item 208
 - Linking to a User Text 253
 - Linking to device 250
 - Properties 212
 - Relinking with device 252

- Renaming information 210
- Information catalog 208
- Information Number 191
- Information number 223
- Initialization string 506
- Initializing 114, 376
- Initiator category 308
- Input and display mode 295
- Installing updates 153
- Instanceable functions 26
- Instrumentation and control system 18
- Inter Relay Communication 181, 182
- Interfaces 168, 282
 - Interface settings 473
- Interlockings 360
- Interlocks 32
- Intermediate position 214
- Internal clock 283
- IRC combination 506
- IRIG B 21, 339
- ISDN modems 383

K

- Key function 36
- Keyboard settings 473
- Keyboard shortcuts 234
- Keystitches 35

L

- Language 168
- Latched 186, 188
- LED 182, 188
- LEDs 24, 322
- Library
 - Printing out 269
 - Selecting 268
 - Selecting a device 276
 - Zooming the display 243
- Limit measured value
 - Configuring 231
 - Configuring 231
- Line
 - Deleting all 246
 - Deleting an area 246
 - Deleting line symbols 245
 - Drawing horizontal lines 244
 - Drawing intersections 245
 - Drawing symbol 271
 - Drawing vertical lines 242
 - Line symbols 243
- Line symbols
 - Delete 245
- Link address 506
- Linking
 - Device to information 250
 - Linking a User Text 253
 - Relinking devices 252
- List view 506
- Logging 32

- Logic functions 232
- Long text 181, 210
- Low-level plug connectors 69

M

- Maintenance measures 450
- Managing 100
- Manual overwriting 357
- Mapping file 441
- Master system 394, 396, 410
- Maximum message gap 380
- Maximum value 326
- Mean values 326
- Measured value
 - Measured value window 195
- Measured value processing 230
- Measured values 30
 - Parameterizing 231
- Measured values - user-defined 325
- Measuring techniques 18
- Measuring transducer 167, 291
 - Inserting into functional scope 230
- Measuring transducer blocks 230
- Menu
 - Context menu 472
 - context-specific 472
- Menu bar 472
- Metered values
 - Metered value window 195
 - Restoring metered values 227
- Miniature fuse 467
- Minimum value 326
- MLFB 464
- MLFB extension 170, 440
- MLFB Number 170, 507
- MODBUS 368, 439
- MODBUS ASCII/RTU 19, 21, 282
- Modem connection 507
- Modem profile 507
- Modems 507
- Module parameter set 409
- Monitor operation 463
- Move 323
 - Area symbol 274
 - Positioned device 252
 - Positioned symbol 258
 - Positioned text 259

N

- NCM database 400
- Network configuration 410
- Nominal size 262
- Number 181
- Number of bits 215
- Number of chatter checks 229
- Number of taps 215

O

- Object

- Open device 278
 - Object list 160, 161
 - Object names 158
 - Object properties 90, 108, 507
 - Object types 87
 - Device container 108, 505
 - Folder 505
 - Modem connection 507
 - Modems 507
 - Phone book 508
 - Project 508
 - SIPROTEC 4 device 169
 - SIPROTEC 4 variant 510
 - Objects 86, 507
 - Copying 91
 - Deleting 91
 - Inserting 89
 - Opening 89
 - Opening objects 89
 - Offline 112, 511
 - Online 112, 371, 508
 - Opening 113
 - Default display 239
 - Header for editing 240
 - Opening a dynamic editor 278
 - Operating instructions
 - Check boxes 474
 - Command buttons 475
 - Drag-and-drop 474
 - Dropdown combo box 475
 - Dropdown lists 475
 - Option boxes 475
 - Section 474
 - Selection box 475
 - Tab 474
 - Operating mode 112, 221, 473
 - Changing the operating mode 118
 - Operating modes 371
 - Operating system 79
 - Operational indications 309
 - Operational measured value 325
 - Inserting 231
 - Operator control panel 23, 29
 - Operator guidance 24, 472
 - Operator interface 25, 36
 - Optical fibers 61, 62
 - Optional products 80, 81
 - Options for fault location 311
 - Ordering code 73
 - Ordering information 472, 492
 - Output 221
- P**
- Packing 72
 - Panel flush mounting 38
 - Panel surface mounting 42
 - Parameter 294
 - Parameter number 294
 - Parameter set 167
 - Parameter set 233, 508
 - Parameterization 508
 - Parameterizing 116
 - Password 221
 - Activating the password 138
 - Deactivating a password 138
 - Password prompt 140
 - Resetting all passwords 139
 - Passwords 24, 28, 32, 135
 - PC port 372, 376
 - Percentages 325
 - Persistent output 221
 - PG/PC interface 401
 - Phone book 508
 - Plug-in terminals 57
 - Points
 - Deleting a symbol 273
 - Positioned device
 - Delete 252
 - Move 252
 - Positioned symbol
 - Delete 258
 - Move 258
 - Positioned text
 - Delete 259
 - Move 259
 - Positioning
 - Devices 248
 - Symbol 257
 - Text 259
 - User Text 253
 - Power system data 27, 291
 - Power system data 2 27
 - Primary parameter 295
 - Primary values 325
 - Printing
 - Default display 263
 - Library 269
 - Print selection 161
 - Printing an object list 160
 - Process data
 - Deleting process data 323
 - Selecting process data off-line 306
 - PROFIBUS 19, 21, 109, 282, 508, 511
 - PROFIBUS address 508
 - PROFIBUS address 371
 - PROFIBUS DP 19, 21, 282, 368, 439
 - PROFIBUS FMS 19, 21, 282, 368
 - PROFIBUS FMS address 407, 408
 - PROFIBUS FMS driver 392
 - Project
 - Closing 93
 - Storage location 97
 - Projects 508
 - Archiving projects 105
 - Closing projects 93
 - Creating projects 88
 - Managing projects 100
 - Opening projects 93

- Reorganizing projects 99
- Retrieving projects 107
- Structuring projects 86
- Properties 178, 212
- Protection devices 508
- Protocol IEC 60870-5-103 175
- Pulse output 221
- Pulse type 217

R

- Radio clock 283
- Range
 - Copy 274
 - Delete 246, 273
 - Move 274
- Reading and setting the date 338
- Reading and setting the time 338
- Reading out
 - Counters and memories 320
 - Measured values 328
 - Metered values 328
 - Operational indications 77
 - Operational measured values 77
 - Type designation 76
- Reassembly of device 468
- Rectangle
 - Drawing symbol 271
- Relative time base 227
- Release object 219, 221
- Reorganizing 99
- Replacing the buffer battery 450
- Replacing the miniature fuse 467
- Report 476
- Representation
 - Default display in normal size 262
 - Zoom in 239
 - Zoom out 239
- Reset 140, 176, 292, 403
 - Counters and memories 321
 - Metered values 331
 - Minimum and Maximum Values: 331
- Reset key 140
- Resetting 331
- Restart 116, 213, 403
- Restore type 217
- Resume 116
- Retrieving 107
 - Options 107
- Retrigger filter 214
- Return 469
- RIO Export 148

S

- Sample display 215
- Saving
 - Default display 264
 - Empty default display 235
 - Symbol 274
- Saving the indication memory 318

- Scaling the measured values 444
- Scope of information 204
- Screw-type terminals 50
- Seal-in time 221
- Secondary parameter 295
- Secondary values 325
- Selecting a device library 276
- Selecting a symbol library 268
- Selecting all in the Display Editor 246
- Selection
 - All in the Display Editor 246
 - Library 268
 - Symbol library 268
- Selection box 475
- Sensitive ground-fault measured value 325
- Serial interfaces 21
- Service interface 23, 25, 29, 509
- Set Status 358
- Setting
 - Counters and memories 321
 - Limit values 329
- Setting indications 461
- Setting notes 488
- Setting parameters 25
- Setting value 282, 286, 293
- Settings group 168, 174
 - Changing over the settings groups 174
 - Copying a settings group 175
 - Displaying settings group 174
 - Resetting a settings group 176
- Settings groups 27
- Short 54
- Short circuit links 54
- Short Text 210
- Short text 210
- Short view 203
- SICAM station 404, 405
- SICAM-Proxy VD address 370
- Signal relay 187
- SIGRA 4 31
- SIMATIC Manager
 - Closing data areas 474
 - Opening data areas 474
- SIPROTEC 509
 - SIPROTEC 4 device 509
 - Close a SIPROTEC 4 device 120
 - Opening the SIPROTEC 4 device 113
- SIPROTEC 4 variant 510
- SIPROTEC-T103 VD address 370
- SIPROTEC-VD-Adresse 370
- Slave 511
- Source 181
- Specifying
 - Device designation 277
 - Device properties 278
 - Device width 277
 - Symbol designation 269
 - Symbol height 269
 - Symbol width 269

- Type of device 277
 - Specifying device object properties 278
 - Specifying the brush size 271
 - Specifying the device properties 278
 - Specifying the line width 271
 - Spin box 475
 - Spontaneous displays 311
 - Spontaneous indications 317, 473
 - Standard view 203
 - State change 229
 - Status 32
 - Status bar 234, 473
 - STEP 7 109
 - Storage 82
 - Subnet 406, 408
 - Switching authority 361
 - Switching mode 363
 - Symbol
 - Copying an area 274
 - Creating a new one 268
 - Creating an empty 269
 - Delete 275
 - Deleting a positioned symbol 258
 - Deleting all 274
 - Deleting an area 273
 - Deleting points 271, 273
 - Drawing a circle 272
 - Drawing a line 271
 - Drawing a rectangle 271
 - Drawing an ellipse 272
 - Drawing freehand 271
 - Drawing mode 271
 - Filling a surface 273
 - Line symbol 243
 - Moving a positioned symbol 258
 - Moving an area 274
 - Positioning 257
 - Saving 274
 - Specifying the symbol designation 269
 - Specifying the symbol height 269
 - Specifying the symbol width 269
 - Tools drawing 271
 - Symbol designation 269
 - Symbol height 269
 - Symbol width 269
 - Symbols
 - Positioned in the default display 256
 - Synchronism 167, 291
 - System interface 29, 181, 182, 189, 190, 283, 440, 510
 - System interlocking 219
 - System load 462
 - System management 108, 171
 - System overview 17, 83
 - System time 117
- T**
- Table parameter 293, 295
 - Taggings 32, 361
 - Terminal adapter 383
 - Termination system 59, 61, 64
 - Test bit 461
 - Test fault record 461
 - Test mode 346, 457, 473
 - Text
 - Deleting a positioned text 259
 - Moving a positioned text 259
 - Positioning 259
 - Text and decimal parameters 293
 - Text input box
 - Header 241
 - Thermal measured values 325
 - Time 117
 - Time format 291
 - Time interval 227
 - Time period 284
 - Time synchronization 21, 168, 283
 - Toolbar 472
 - Tools
 - Drawing symbol 271
 - Topological view 108, 510
 - Topology
 - Default display 242
 - Transferring displays to the device 233
 - Transferring parameters 233
 - Transformer data 27
 - Transmission blocking 346, 457, 473
 - Transmission causes 308
 - Troubleshooting 463
 - Type 181
- U**
- Unlatched 186, 188
 - Unpacking 72
 - Update 32
 - Updating 155
 - User address 510
 - User interface 34
 - User Text
 - Assigning text 255
 - Linking 253
 - Positioning 253
 - Users 510
- V**
- Value 294
 - Variable addresses 411
 - Variable lengths 411
 - Variant 121
 - VD 511
 - VD address 369, 511
 - Version number 156
 - Versions 154
 - Vertical filtering 202
 - VFD 511
 - View
 - Component view 502
 - Filtering 96

Topological view 510
Voltage input 181

W

Wire-bound serial interfaces 65
Wiring diagrams 487
www.siemens.com/power-academy-td 4

Z

Zone controlled 219
Zone diagram 300
 Hiding and displaying zones 301
 Increasing and reducing the zone diagram
 301
Zoom in
 Representation 239
Zoom out
 Representation 239