

FT 328

Reflection light scanners with fading

en 01-2013/06 50123666



Dimensioned drawing

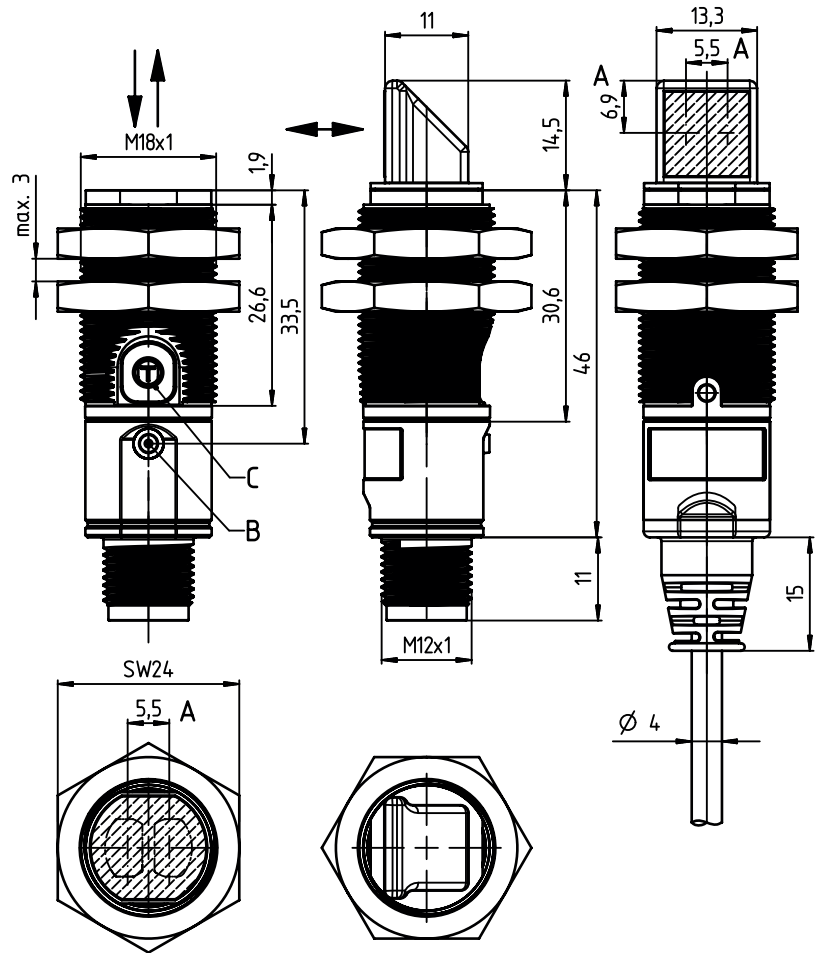

- A Optical axes
- B Indicator diode
- C Teach button



1 ... 280mm
2 ... 120mm
(with 90° angular optics)



- Diffuse reflection light scanners with fading
- V-optics allow for reliable detection of dark objects in the short range
- Scanning range adjustment via teach-in
- Visible red light
- Axial and 90° light beam gate for flexible integration
- Active suppression of extraneous light A²LS
- Fast alignment through *brightVision*®
- Simple fine adjustment via *omni-mount*
- Sturdy plastic housing with stainless steel threaded sleeve with cylindrical M18x1 design
- Full control through green and yellow indicator LEDs

Electrical connection



Accessories:

(available separately)

- Mounting systems (BT D18M.5, BT 318...)
- M12 connectors (KD ...)
- Ready-made cables (K-D ...)

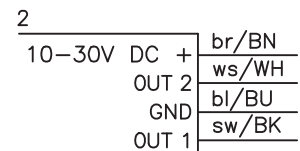
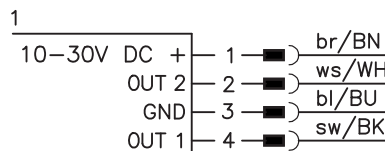

We reserve the right to make changes • DS_FT328_en_50123666.fm

Specifications

Optical data

| | |
|------------------------------------|--|
| Scanning range limit ¹⁾ | axial optics: 1 ... 280mm |
| Scanning range ²⁾ | 90° optics: 2 ... 120mm |
| Light source | see tables |
| Wavelength | LED (modulated light) 620nm (visible red light) |

Timing

| | |
|-----------------------|---------|
| Switching frequency | 500Hz |
| Response time | 1ms |
| Delay before start-up | ≤ 300ms |

Electrical data

| | |
|-------------------------|---|
| Operating voltage U_B | 10 ... 30VDC (incl. residual ripple) |
| Residual ripple | ≤ 15% of U_B |
| Open-circuit current | ≤ 20mA |
| Switching output | .../4P... 2 PNP transistor outputs pin 2: PNP dark switching, pin 4: PNP light switching |
| | .../2N... 2 NPN transistor outputs pin 2: NPN dark switching, pin 4: NPN light switching |
| | ≥ ($U_B - 2.5V$) / ≤ 2.5V |
| | max. 100mA ³⁾ |

Signal voltage high/low
Output current

Indicators

| | |
|------------|------------------------------|
| Green LED | ready |
| Yellow LED | reflection (object detected) |

Mechanical data

| | |
|-----------------|---|
| Housing | plastic |
| Optics cover | plastic |
| Weight | 30g with M12 connector 80g with 2m cable |
| Connection type | M12 connector, 4-pin cable 2m, 4x0.20mm ² |

Environmental data

| | |
|-----------------------------------|--------------------------------------|
| Ambient temp. (operation/storage) | -40°C ... +60°C / -40°C ... +70°C |
| Protective circuit ⁴⁾ | 2, 3 |
| VDE safety class | III |
| Protection class | IP 67 |
| Light source | exempt group (in acc. with EN 62471) |
| Standards applied | IEC 60947-5-2 |

- 1) Scanning range limit: typical scanning range
- 2) Scanning range: ensured scanning range
- 3) Sum of the output currents for both outputs, 50mA when ambient temperatures > 40°C
- 4) 2=polarity reversal protection, 3=short circuit protection for all outputs



Fading: black/white error < 50%

Example axial optics:

Adjustment 160mm, white 90%

- **Detection:**
Black object, 6%, is detected at approx. 100mm

Adjustment 120mm, black 6%

- **Situation in the background:**
White object, 90%, is no longer detected at a distance > 200mm

Example 90° angular optics

Adjustment 85mm, white 90%

- **Detection:**
Black object, 6%, is detected at approx. 50mm

Adjustment 65mm, black 6%

- **Situation in the background:**
White object, 90%, is no longer detected at a distance > 110mm

Tables

Axial optics:

| | | | |
|---|---|-----|-----|
| 1 | 1 | 215 | 280 |
| 2 | 5 | 125 | 160 |

90° optics:

| | | | |
|---|---|-----|-----|
| 1 | 2 | 100 | 120 |
| 2 | 8 | 65 | 80 |

| | |
|---|-----------|
| 1 | white 90% |
| 2 | black 6% |

| | |
|---|--------------------------------|
| □ | Scanning range [mm] |
| ■ | Typ. scanning range limit [mm] |

Diagrams

Axial optics:

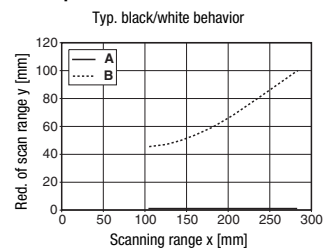

90° optics:

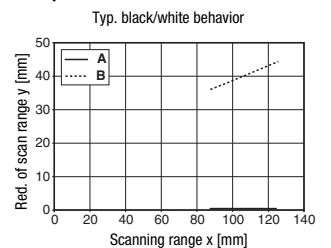

Remarks

- **Approved purpose:**
This product may only be used by qualified personnel and must only be used for the approved purpose. This sensor is not a safety sensor and is not to be used for the protection of persons.
- With the set scanning range, a tolerance of the scanning range limits is possible depending on the reflection properties of the material surface.

FT 328

Reflection light scanners with fading

Order guide

The sensors listed here are preferred types; current information at www.leuze.com.

| | | Designation | Part no. |
|--|--|---|--------------------------|
| Sensors with axial optics | With M12 connector | Pin 4: PNP light switching, pin 2: PNP dark switching | FT328.3/4P-M12 50122717 |
| | | Pin 4: NPN light switching, pin 2: NPN dark switching | FT328.3/2N-M12 50122719 |
| | With cable, 2m | Pin 4: PNP light switching, pin 2: PNP dark switching | FT328.3/4P 50122718 |
| | | Pin 4: NPN light switching, pin 2: NPN dark switching | FT328.3/2N 50122720 |
| Sensors with 90° angular optics | With M12 connector | Pin 4: PNP light switching, pin 2: PNP dark switching | FT328.W3/4P-M12 50122713 |
| | | Pin 4: NPN light switching, pin 2: NPN dark switching | FT328.W3/2N-M12 50122715 |
| | With cable, 2m | Pin 4: PNP light switching, pin 2: PNP dark switching | FT328.W3/4P 50122714 |
| | | Pin 4: NPN light switching, pin 2: NPN dark switching | FT328.W3/2N 50122716 |
| Accessories for optimum fastening | Mounting system <i>omni-mount</i> | BT318B-0M | 50121904 |
| | Mounting bracket for standard mounting | BT D18M.5 | 50113548 |
| | Mounting bracket for <i>omni-mount</i> | BT D21M | 50117257 |

Part number code

| | | F | T | 3 | 2 | 8 | . | W | 3 | / | 4 | P | - | M | 1 | 2 |
|--|------|---|---|---|---|---|---|---|---|---|---|---|---|---|---|---|
| Operating principle | FT | Diffuse reflection light scanners with fading | | | | | | | | | | | | | | |
| Series | 328 | 328 Series | | | | | | | | | | | | | | |
| Equipment | .3 | Axial optics, Teach-in via teach button | | | | | | | | | | | | | | |
| | .W3 | 90° angular optics, Teach-in via teach button | | | | | | | | | | | | | | |
| Switching output/function /OUT1/OUT2 (OUT1 = Pin 4, OUT2 = Pin 2) | 4 | PNP, light switching | | | | | | | | | | | | | | |
| | P | PNP, dark switching | | | | | | | | | | | | | | |
| | 2 | NPN, light switching | | | | | | | | | | | | | | |
| | N | NPN, dark switching | | | | | | | | | | | | | | |
| | X | Pin not used | | | | | | | | | | | | | | |
| Electrical connection | -M12 | M12 connector, 4-pin | | | | | | | | | | | | | | |
| | N/A | Cable, standard length 2m | | | | | | | | | | | | | | |

Teach-in method

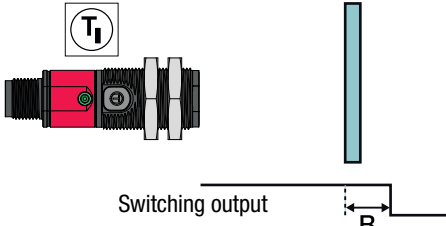
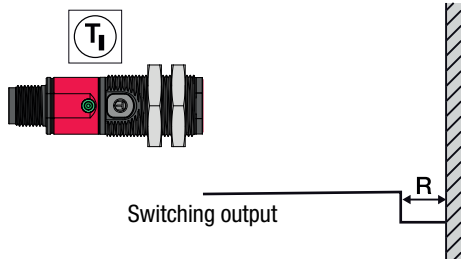
| Teach | Operating level 1 | Operating level 2 |
|----------------|---|--|
| Standard Teach | <p>Teach on object:</p> <p>In this teach version, the switching distance is set so that the object that is in the beam path during the teach is detected with a tight reserve. The additional distance by which the scanning range is increased in relation to the distance to the teach object is designated as reserve R. All objects up to a bit above the distance of the object used in the teach are thus detected.</p>  | <p>Teach on background:</p> <p>This teach is only suitable for applications with a fixed background. The teach is carried out without an object. The scanning range is placed in front of the teach object with reserve R. The scanning range is set by the teach so that detection stops just short of the background.</p>  |

Operation via teach button

Teach in operating level 1

- Press teach button until the **yellow** LED flashes.
- Release teach button.
- Ready.

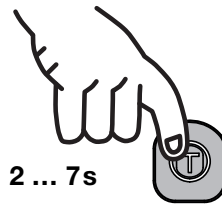

Teach in operating level 2

- Press teach button until green and yellow LEDs flash **alternately**.
- Release teach button.
- Ready.

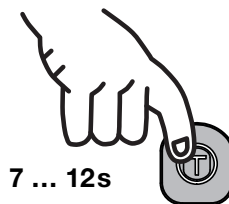

Adjusting the switching behavior of the switching output – light/dark switching

This function permits inversion of the sensors' switching logic.

- Press teach button until the **green** LED flashes.
- Release teach button.
- The LED then displays the changed switching logic for 2s:

- YELLOW Continuous light** = switching outputs **light switching** (in the case of complementary sensors, Q1 (pin 4) light switching, Q2 (pin 2) dark switching), this means output active when object is detected.
- GREEN Flashing light** = switching outputs **dark switching** (in the case of complementary sensors, Q1 (pin 4) dark switching, Q2 (pin 2) light switching), this means output inactive when object is detected.

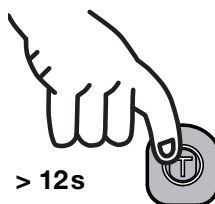

2s YELLOW = light switching

or

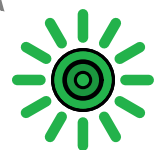

flashes GREEN for 2s = dark switching

- Ready.