

HRTR 53 V Reflect. light scanner with V-optics and background suppression

en 01-2012/08 50120885



15 ... 100mm
100mm with
black-white error < 10%



- Diffuse reflection light scanner with visible red light, V-optics and adjustable background suppression
- Due to the V-optics, it is particularly well-suited for detecting very shiny or polished surfaces as well as for transparent objects in a range of 30 ... 70mm
- Very good black/white behavior and precise background suppression
- Exact scanning range adjustment through 8-turn potentiometer
- High switching frequency for detection of fast events

Dimensioned drawing

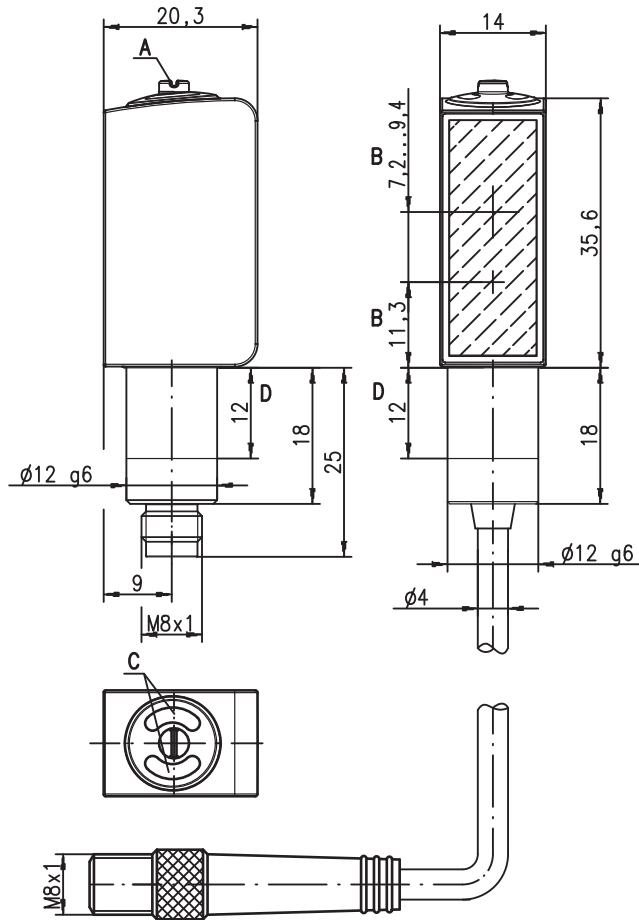

- A** Green indicator diode
- B** Yellow indicator diode
- C** Optical axis
- D** 8-turn potentiometer for scanning range adjustment
- E** Mounting sleeve

Electrical connection

Plug connection, 4-pin

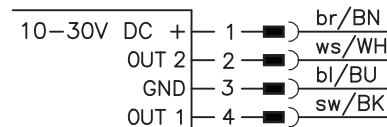

We reserve the right to make changes • DS_HRTR53V_en_50120885.fm



Accessories:

(available separately)

- BTU 053 mounting system
- Cable with M8 or M12 connector (K-D ...)

Specifications

Optical data

Scanning range ¹⁾	18 ... 100mm
Adjustment range ¹⁾	20 ... 100mm
Black-white error	< 10% up to 100mm
Light beam exit angle	typ. 11°
Light beam characteristic	focussed at 200mm
Light source ²⁾	LED (modulated light)
Wavelength	620nm (visible red light)

Timing

Switching frequency	1,000Hz
Response time	0.5ms
Delay before start-up	≤ 300ms (acc. to. IEC 60947-5-2)

Electrical data

Operating voltage U_B ³⁾	10 ... 30VDC (incl. residual ripple)
Residual ripple	≤ 15% of U_B
Open-circuit current	≤ 15mA
Switching output	.../66 ⁴⁾ 2 push-pull switching outputs pin 2: PNP dark switching, NPN light switching pin 4: PNP light switching, NPN dark switching
Function characteristics	light/dark switching
Signal voltage high/low	$\geq (U_B - 2V) / \leq 2V$
Output current	max. 100mA
Scanning range	adjustable via 8-turn potentiometer

Indicators

Green LED	ready
Yellow LED	object detected - reflection

Mechanical data

Housing	AISI 316L stainless steel, DIN X2CrNiMo17132, W.No1.4404
Housing design	HYGIENE-Design
Housing roughness ⁵⁾	$R_a \leq 2.5$
Connector	AISI 316L stainless steel, DIN X2CrNiMo17132, W.No1.4404
Optics cover	coated plastic (PMMA), scratch resistant and non-diffusive
Operation	plastic (TPV-PE), non-diffusive
Weight	with M8 connector: 50g with 200mm cable and M8 connector: 60g
Connection type	M8 connector, 4-pin or 3-pin
Fastening	0.2m cable with M8 connector, 4-pin
Max. tightening torque	via fit (see Remarks) 3 Nm (permissible range, see dimensioned drawing)

Environmental data

Ambient temp. (operation/storage) ⁶⁾	-30°C ... +70°C / -30°C ... +70°C
Protective circuit ⁷⁾	2, 3
VDE safety class ⁸⁾	III
Protection class	IP 67, IP 69K ⁹⁾
Environmentally tested acc. to	ECOLAB, CleanProof+
LED class	1 (in accordance with EN 60825-1)
Standards applied	IEC 60947-5-2
Certifications	UL 508 ³⁾
Chemical resistance	tested in accordance with ECOLAB and CleanProof+ (see Remarks)

- 1) Scanning range: recommended scanning range for objects with different diffuse reflection
- 2) Average life expectancy 100,000h at an ambient temperature of 25°C
- 3) For UL applications: for use in class 2 circuits according to NEC only
- 4) The push-pull switching outputs must not be connected in parallel
- 5) Typical value for the stainless steel housing
- 6) Operating temperatures of +70°C permissible only briefly (≤ 15min)
- 7) 2=polarity reversal protection, 3=short circuit protection for all transistor outputs
- 8) Rating voltage 50V
- 9) Only with internal tube mounting of the M8 connector

● **Approved purpose:**

This product may only be used by qualified personnel and must only be used for the approved purpose. This sensor is not a safety sensor and is not to be used for the protection of person.

Tables

1	15	100
2	15	96
3	15	94

1	white 90%
2	gray 18%
3	black 6%

Scanning range [mm]

Diagrams

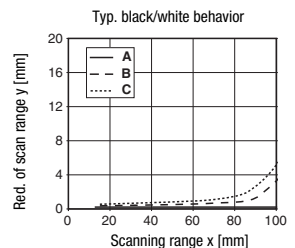
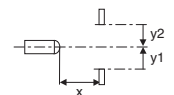
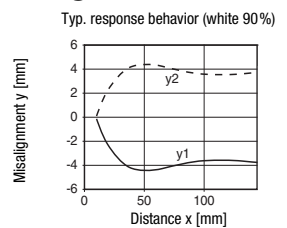

- A white 90%
- B gray 18%
- C black 6%

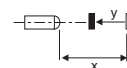

HRTR 53 V Reflect. light scanner with V-optics and background suppression

Order guide

Selection table		Order code →	
Equipment ↓		HRTR 53/66-V-S8 Part no. 50120622	
Switching output	2 x push-pull switching output		●
	1 x push-pull switching output		
Switching function	1 PNP light switching and NPN dark switching output		●
	1 PNP dark switching and NPN light switching output		●
Connection	M8 connector, metal, 4-pin		●
	M8 connector, metal, 3-pin		
	cable 200mm with M12 connector, 4-pin		
	cable 5000mm, 4-wire		
Indicators	green LED: ready		●
	yellow LED: switching output	●	

Application notes



- The sensor must be positioned perpendicularly and parallel to the object.
- Objects should only be moved laterally from the right or left. Moving in objects from the connector side or operating side is not permitted.

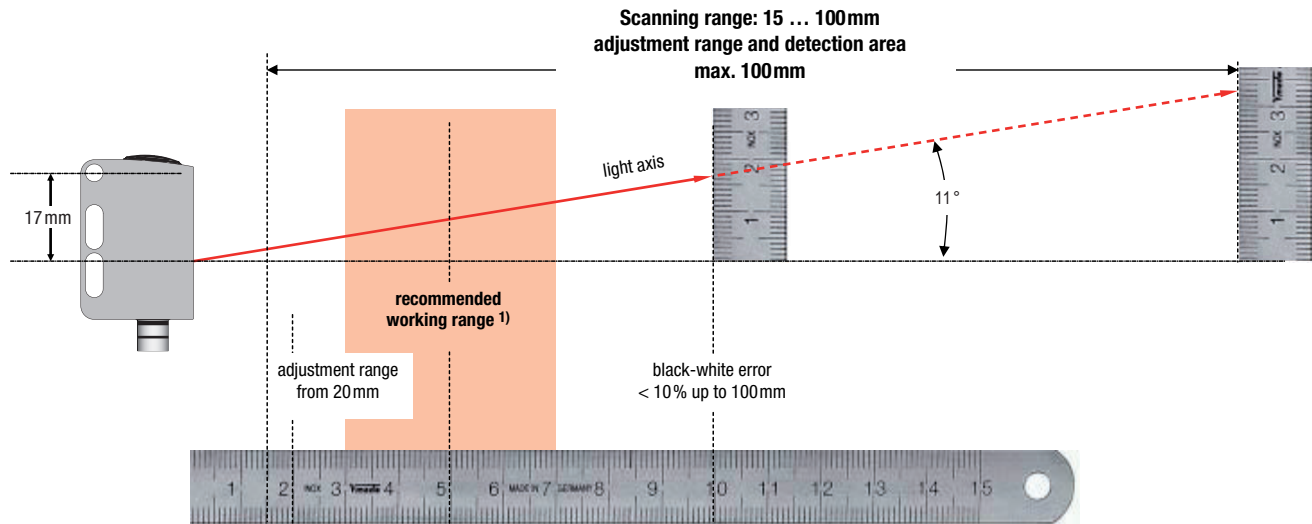

1) The sensor is most capable of reliably detecting a reflective surface or transparent object in the recommended working range. Nevertheless, the sensor can reliably detect such objects in the entire scanning range; however, the performance reserve is reduced as compared with the recommended working range.



- The sensors are equipped with effective measures for the maximum avoidance of mutual interference should they be mounted opposite one another. Opposite mounting of multiple sensors of the same type should, however, absolutely be avoided.