

HRTR 55 "S"

Diffuse reflection light scanner with background suppression

en 04-2012/11 50107827-01



Dimensioned drawing

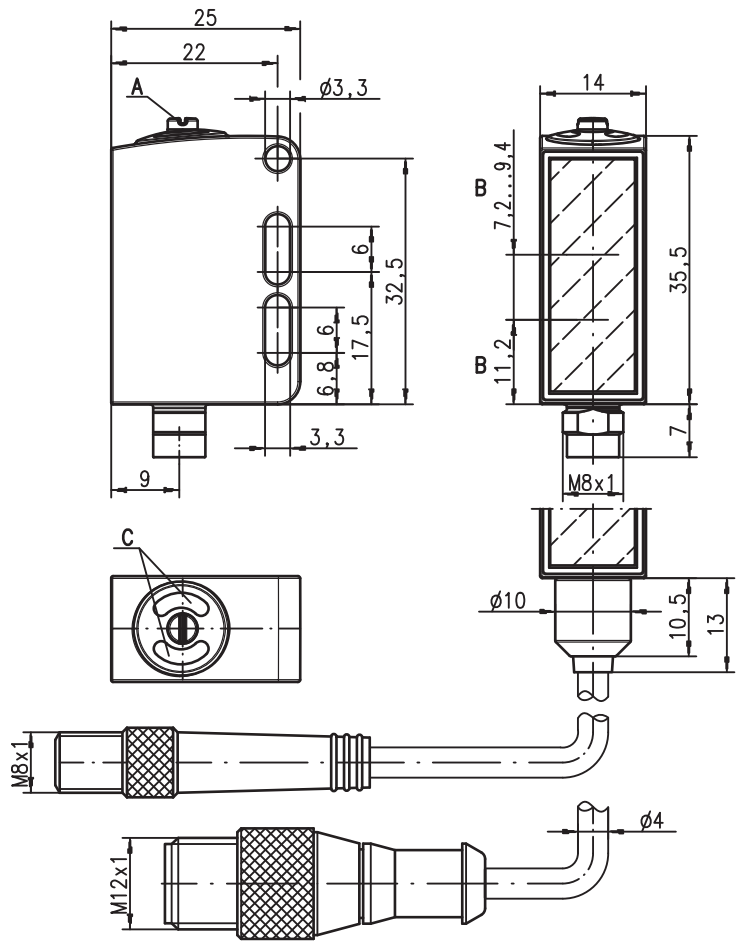

- A** Adjustment screw
- B** Optical axis
- C** Indicator diodes

Electrical connection

Plug connection, 4-pin (with/without cable)

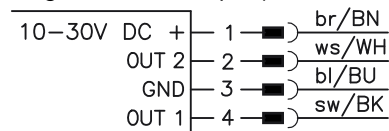

Connector, 3-pin

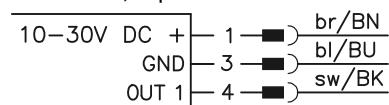

5 ... 200mm
100mm with
black-white error < 10%

10 - 30 V DC
A²LS
stainless steel 316 L

- Diffuse reflection light scanner with visible red light and adjustable background suppression
- 316L stainless steel housing in Hygiene-Design
- Enclosed optics design prevents bacterial carry-overs
- ECOLAB and CleanProof+ tested
- Paperless device identification
- Scratch resistant and non-diffusive plastic front cover
- Exact scanning range adjustment through 8-turn potentiometer
- Very good black/white behavior and reliable switching, even on glossy objects and objects with colored structure
- Small, homogeneous light spot for detecting small parts
- A²LS- Active Ambient Light Suppression
- Push-pull switching outputs
- High switching frequency for detection of fast events

CE, UL LISTED, ECOLAB CleanProof+, IEC 60947..., IEC 60947..., IP 69K IP 67, WASH DOWN

Accessories:

(available separately)

- Cable with M8 or M12 connector (K-D ...)
- Cable for food and beverages
- Mounting devices

We reserve the right to make changes • DS_HRTR55S_en_50107827-01.fm

Specifications

Optical data

Typ. scanning range limit ¹⁾	5 ... 200mm
Scanning range ²⁾	see tables
Adjustment range	15 ... 200mm
Light spot	approx. Ø 4mm at 100mm
Light source ³⁾	LED (modulated light)
Wavelength	660nm (visible red light)

Timing

Switching frequency	1000Hz
Response time	0.5ms
Delay before start-up	≤ 300ms (acc. to. IEC 60947-5-2)

Electrical data

Operating voltage U_B ⁴⁾	10 ... 30VDC (incl. residual ripple)
Residual ripple	≤ 15% of U_B
Open-circuit current	≤ 15mA
Switching output	.../66 ⁵⁾ 2 push-pull switching outputs pin 2: PNP dark switching, NPN light switching pin 4: PNP light switching, NPN dark switching .../6 ⁵⁾ 1 push-pull switching output pin 4: PNP light switching, NPN dark switching light/dark switching
Function characteristics	adjustable via 8-turn potentiometer
Signal voltage high/low	$\geq (U_B - 2V) / \leq 2V$
Output current	max. 100mA
Scanning range	

Indicators

Green LED	ready
Yellow LED	object detected - reflection

Mechanical data

Housing	AISI 316L stainless steel, DIN X2CrNiMo17132, W.No1.4404
Housing design	WASH-DOWN-Design
Housing roughness ⁶⁾	$Ra \leq 2.5$
Connector	AISI 316L stainless steel, DIN X2CrNiMo17132, W.No1.4404
Optics cover	coated plastic (PMMA), scratch resistant and non-diffusive
Operation	with M8 connector: 40g
Weight	with 200mm cable and M12 connector: 60g with 5000mm cable: 110g
Connection type	M8 connector, 4-pin, 0.2m cable with M12 connector, 4-pin 5m cable, 4 x 0.20mm ²

Environmental data

Ambient temp. (operation/storage) ⁷⁾	-30°C ... +70°C / -30°C ... +70°C
Protective circuit ⁸⁾	2, 3
VDE safety class ⁹⁾	III
Protection class	IP 67, IP 69K ¹⁰⁾
Environmentally tested acc. to	ECOLAB, CleanProof+
LED class	1 (in accordance with EN 60825-1)
Standards applied	IEC 60947-5-2
Certifications	UL 508 ⁴⁾
Chemical resistance	tested in accordance with ECOLAB and CleanProof+ (see Remarks)

- 1) Typ. scan. range limit: max. achievable scanning range for light objects (white 90%)
- 2) Scanning range: recommended scanning range for objects with different diffuse reflection
- 3) Average life expectancy 100,000h at an ambient temperature of 25°C
- 4) For UL applications: for use in class 2 circuits according to NEC only
- 5) The push-pull switching outputs must not be connected in parallel
- 6) Typical value for the stainless steel housing
- 7) Operating temperatures of +70°C permissible only briefly (≤ 15min)
- 8) 2=polarity reversal protection, 3=short circuit protection for all transistor outputs
- 9) Rating voltage 50V
- 10) Only in combination with M12 connector

Approved purpose

The light scanners are optical electronic sensors for optical, contactless detection of objects. This product may only be used by qualified personnel and must only be used for the approved purpose. This sensor is not a safety sensor and is not to be used for the protection of persons.

Tables

1	5	200
2	10	150
3	15	120

1	white 90%
2	gray 18%
3	black 6%

Scanning range [mm]

Diagrams

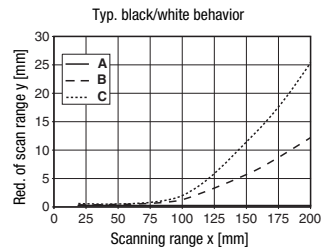
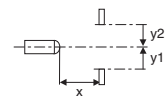
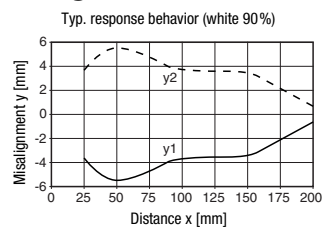

- A white 90%
- B gray 18%
- C black 6%

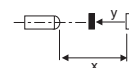

Remarks

A list of tested chemicals can be found in the first part of the product description.

HRTR 55 "S"

Diffuse reflection light scanner with background suppression

Order guide

Selection table		Order code →	HRTR 55/66-S-S8 Part no. 50107493	HRTR 55/6-S-S8.3 Part no. 50107494	HRTR 55/66-S-200-S12 Part no. 50107495	HRTR 55/66-S-5000 Part no. 50114069
Equipment ↓						
Switching output	2 x push-pull switching output		●		●	●
	1 x push-pull switching output			●		
Switching function	1 PNP light switching and NPN dark switching output		●	●	●	●
	1 PNP dark switching and NPN light switching output		●		●	●
Connection	M8 connector, metal, 4-pin		●			
	M8 connector, metal, 3-pin			●		
	cable 200 mm with M12 connector, 4-pin				●	
	cable 5000 mm, 4-wire					●
Indicators	green LED: ready		●	●	●	●
	yellow LED: switching output		●	●	●	●

Application notes



- For glossy surfaces (e.g. metals), the light beam should not be incident on the object surface at a right angle. A slight inclination is sufficient for preventing undesired direct reflections. This may result in a reduction in the scanning range.
- Objects should only be moved laterally from the right or left. Moving in objects from the connector side or operating side is to be avoided.
- Outside of the scanning range, the sensor operates as an energetic diffuse reflection light scanner. Light objects can still be reliably detected up to the scanning range limit.
- The sensors are equipped with effective measures for the maximum avoidance of mutual interference should they be mounted opposite one another. Opposite mounting of multiple sensors of the same type should, however, absolutely be avoided.

