

LES 36

Light section sensor for object measurement

en 03-2013/03 50116495-01



200 ... 800mm

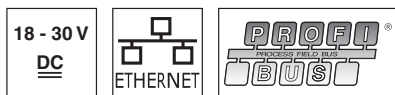

- Light section sensor for object measurement (width, height and position measurement)
- Measurement time 10ms
- Measurement range: 200 ... 800mm
- Length of laser line: max. 600mm
- Integrated PROFIBUS interface or analog output
- Configuration via Fast Ethernet
- OLED display with key pad for alignment aid and status display: "set inspection task"
- Measurement value display in mm on OLED display as an alignment aid
- Up to 4 measurement fields / 8 detection fields with logic operation option
- Up to 16 inspection tasks
- Activation input, trigger input, cascading output
- PROFIBUS connection via Y adapter



Accessories:

(available separately)

- Mounting systems BT 56, BT 59
- Cable with M12 connector (K-D ...)

Dimensioned drawing

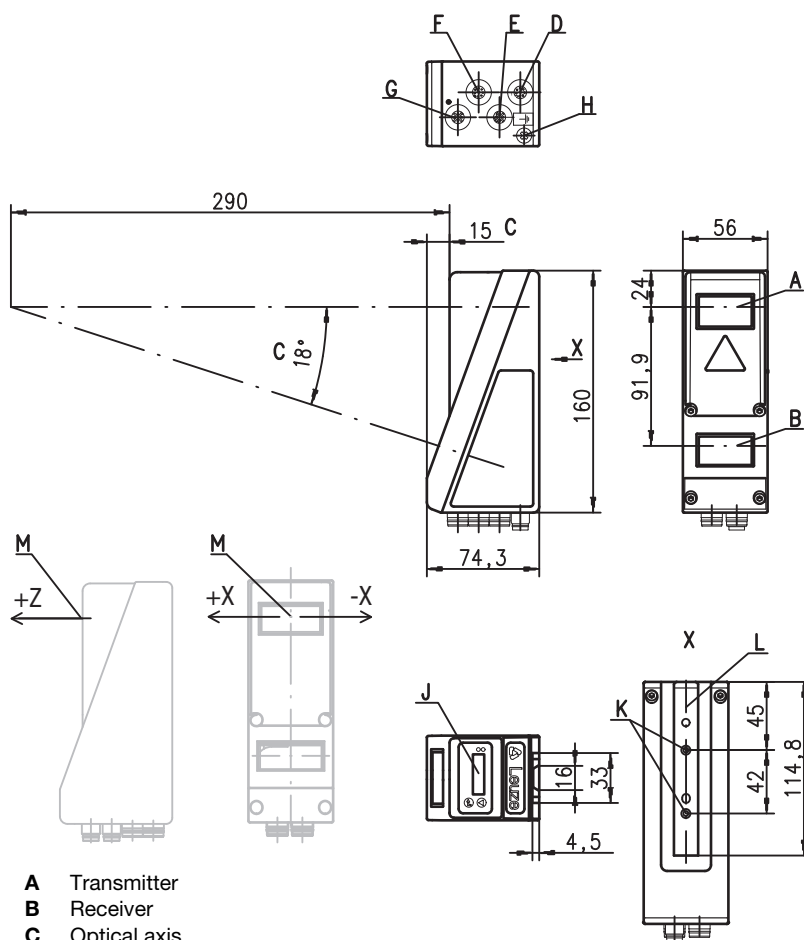

- A Transmitter
- B Receiver
- C Optical axis
- D X1: M12x1 connector, 8-pin, A coded
- E X2: M12x1 socket, 4-pin, D coded
- F X3: M12x1 socket, 8-pin, A coded (LES 36/VC6 only)
- G X4: M12x1 socket, 5-pin, B coded (LES 36/PB), M12x1 socket, 5-pin, A coded (LES 36/VC, LES 36/VC6)
- H FE screw
- J OLED display and membrane keyboard
- K M4 thread, 4.5 deep
- L Holder for mounting system BT 56 / BT 59
- M Zero point and orientation of the coordinate system for measurement data

Measurement range, typical

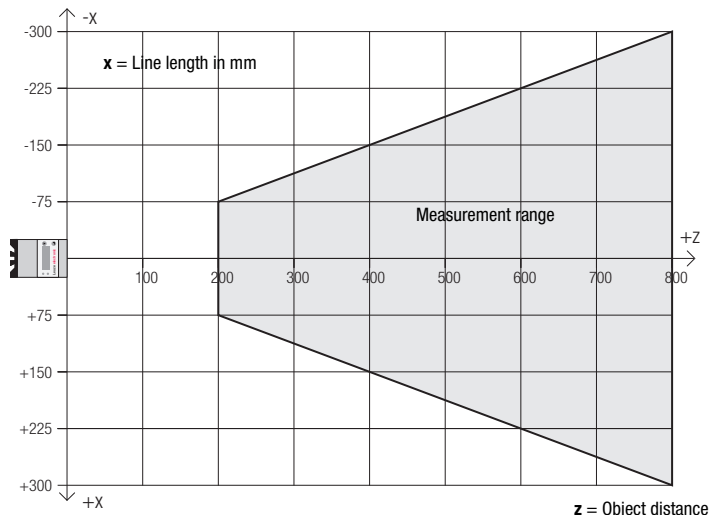

We reserve the right to make changes • DS_LES36_en_50116495-01.fm

Specifications

Optical data

Measurement range ¹⁾	200 ... 800mm (z direction)
Light source	laser
Wavelength	658nm (visible red light)
Max. output power	< 8mW
Pulse duration	< 3ms (adjustable from 0.1 ms ... 1.31ms)
Laser line	600x3mm at 800mm

Error limits (relative to measurement distance)

Resolution in x direction ^{2) 3)}	1 ... 1.7mm
Resolution in z ^{2) direction 3)}	1 ... 3mm
Linearity in z direction ³⁾	≤ ±1%
Repeatability in z direction ³⁾	≤ 0.5%
B/W detection thresh. (6 ... 90% rem.)	≤ 1%

Object detection

Minimum object size in x direction ⁴⁾	2 ... 3mm
Minimum object size in z direction ²⁾	2 ... 6mm

Timing

Measurement time	≥10ms (configurable)
Delay before start-up	approx. 1.5s

Electrical data

Operating voltage U_B ⁵⁾	18 ... 30VDC (incl. residual ripple)
Residual ripple	≤ 15% of U_B
Open-circuit current	≤ 200mA
Ethernet interface	UDP
Switching outputs	4 / 100mA / push-pull ⁶⁾ on X3 (LES 36/VC6 only) 1 (ready) / 100mA / push-pull ⁶⁾ on X1 1 (cascading) / 100mA / push-pull ⁶⁾ on X1 3 (selection of inspection task) on X3 (LES 36/VC6 only)
Inputs	1 (trigger) on X1 1 (activation) on X1
Signal voltage high/low	≥ (U_B -2V)/≤ 2V

Analog output (LES 36/VC, LES 36/VC6)

Analog output	voltage 1 ... 10V, R_L ≥ 2kΩ current 4 ... 20mA, R_L ≤ 500Ω
---------------	--

PROFIBUS (only LES 36/PB)

Interface type	1x RS 485 on X4
Protocols	PROFIBUS DP/DPV1 slave
Baud rate	9.6kBaud ... 6MBaud

Indicators

Green LED	continuous light	ready
	off	No voltage
Yellow LED	continuous light	Ethernet connection available
	flashing	Ethernet data transmission active
	off	no Ethernet connection available

Mechanical data

Housing	aluminum frame with plastic cover
Optics cover	glass
Weight	620g
Connection type	M12 connector

Environmental data

Ambient temp. (operation/storage)	-30°C ... +50°C/-30°C ... +70°C
Protective circuit ⁷⁾	1, 2, 3
VDE safety class	III, protective extra-low voltage
Protection class	IP 67
Laser class	2M (according to EN 60825-1 and 21 CFR 1040.10 with Laser Notice No. 50)
Standards applied	IEC/EN 60947-5-2, UL 508

- 1) Luminosity coefficient 6% ... 90%, entire detection range, at 20°C after 30minutes warmup time, medium range U_B
- 2) Minimum and maximum value depend on measurement distance
- 3) Reflectivity 90%, identical object, identical environment conditions, measurement object ≥ 50x50mm²
- 4) Minimum value, depends on distance and object, requires testing under application conditions
- 5) For UL applications: for use in class 2 circuits according to NEC only
- 6) The push-pull switching outputs must not be connected in parallel
- 7) 1=transient protection, 2=polarity reversal protection, 3=short circuit protection for all outputs, requires external protective circuit for inductive loads

Tables

LED	State	Display during measurement operation
green	continuous light	Sensor ready
	off	Sensor not ready
yellow	continuous light	Ethernet connection established
	flashing	Ethernet data transmission active
	off	No Ethernet connection

Diagrams

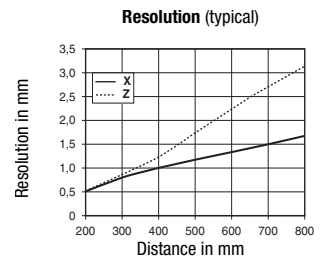
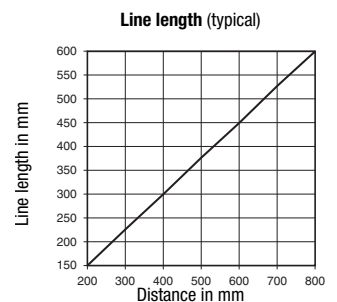

Remarks

- **Approved purpose**
This product may only be used by qualified personnel and must only be used for the approved purpose. This sensor is not a safety sensor and is not to be used for the protection of persons.
- **Warmup time:**
After a warmup time of 30 min., the light section sensor has reached the operating temperature required for an optimum object measurement.
- **For UL:**
CAUTION – Use of controls or adjustments or performance of procedures other than specified herein may result in hazardous light exposure.

Interface assignments

X1 - logic and power		
Pin No.	Signal	Color
1	+24VDC	WH
2	InAct (activation)	BN
3	GND	GN
4	OutReady (ready)	YE
5	InTrig (trigger)	GY
6	OutCas (cascading)	PK
7	Do not connect	BU
8	Do not connect	RD

8-pin M12 plug, A coded

X2 - Ethernet		
Pin No.	Signal	Color
1	Tx+	YE
2	Rx+	WH
3	Tx-	OR
4	Rx-	BU

4-pin M12 socket, D coded

X3 - logic (LES 36/VC6 only)		
Pin No.	Signal	Color
1	Out4	WH
2	Out3	BN
3	GND	GN
4	Out2	YE
5	Out1	GY
6	InSel3 ¹⁾	PK
7	InSel2 ¹⁾	BU
8	InSel1 ¹⁾	RD

8-pin M12 socket, A coded

X4 - Analog Out (LES 36/VC, LES 36/VC6)			
Pin No.	Signal	Explanation	Color
1	n.c.	Not connected	BN
2	4-20mA	Analog current output	WH
3	AGND	Reference potential	BU
4	1-10V	Analog voltage output	BK
5	FE	Functional earth	GY

5-pin M12 socket, A coded

X4 - PROFIBUS (only LES 36/PB)			
Pin No.	Signal	Explanation	Color
1	VP	+5VDC termin.	
2	A	RxD/TxD-N	GN
3	DGND	Reference potential	
4	B	RxD/TxD-P	RD
5	FE	Functional earth	

5-pin M12 socket, B coded

1) The three InSel1-3 switching inputs are used to select inspection tasks 0-7. "000" means inspection task 0, "001" inspection task 1, etc. The changeover time between two inspection tasks is < 100ms

Order guide

Part no.	Designation	Line Range Sensor
50111326	LES 36/VC	with analog voltage and current output
50111333	LES 36/VC6	with analog voltage and current output and binary inputs/outputs
50111327	LES 36/PB	with PROFIBUS DP/DPV1 (the Y adapter is necessary for connecting the sensor , see accessories)

Configuration - Establish connection to PC

The LES is configured via a PC using the **LESsoft** program before it is integrated into the process control.

In order to be able to establish an UDP communication with the PC, the IP address of your PC and the IP address of the LES must lie in the same address range. The LES has no built-in DHCP client, so that you need to set the address manually. This is done the easiest way via the PC.



Notice!

If you are using a desktop firewall, please ensure that the control can communicate with the LES via the Ethernet interface on ports 9008 and 5634 using UDP. Furthermore, the firewall must allow ICMP echo messages to pass through for the connection test (ping).

If the PC is usually connected to a network using DHCP address allocation, the easiest way to access the LES is by applying an alternative configuration in the TCP/IP settings of the PC and connecting the LES directly to the PC.

☞ Check the network address of the LES by pressing the **←** button during normal operation of the LES twice in succession, then by pressing **▼** twice and followed by pressing the **←** button again.

This will take you to the Ethernet submenu and enable you to read the current settings of the LES consecutively when pressing **▼** repeatedly.

☞ Make a note of the values for IP-Address and Net Mask Addr..

The value in Net Mask Addr. specifies which digits of the IP address of the PC and LES must match so that they can communicate with each other.

Address of the LES	Net mask	Address of the PC
192.168.060.003	255.255.255.0	192.168.060.xxx
192.168.060.003	255.255.0.0	192.168.xxx.xxx

Instead of **xxx** you can now allocate any numbers between 000 and 255 to your PC, but NOT THE SAME numbers as contained in the address of the LES.

For example 192.168.060.110 (but not 192.168.060.003!). If LES and PC have the same IP address, they cannot communicate with each other.

Configuring the IP address for a PC

☞ Log in to your PC as an administrator.

☞ Using Start->System control go to the Network connections (Windows XP) menu or to the Network center and release center (Windows Vista) menu.

☞ There select the LAN connection and bring up the associated Features page by right clicking with the mouse.

☞ Select the Internet protocol (TCP/IP) (by scrolling down, if necessary) and click on Properties.

☞ In the Internet protocol (TCP/IP) Properties window select the Alternate configuration tab.

☞ Configure the IP address of the PC in the address range of the LES.
Attention: do not use the same as for the LES!

☞ Set the Subnet mask of the PC to the same value as the one for the LES.

☞ Close the configuration dialog by confirming all windows using **OK**.

☞ Connect the interface X2 of the LES directly to the LAN port of your PC. Use a KB ET-...-SA-RJ45 cable for the connection.

The PC will first try to establish a network connection via the automatic configuration. This will take a few seconds. Following that the alternative configuration, which you have just set up, is activated, and thus the PC can communicate with the LES.

Information about configuring the LES using **LESsoft** software can be found in the Technical Description.

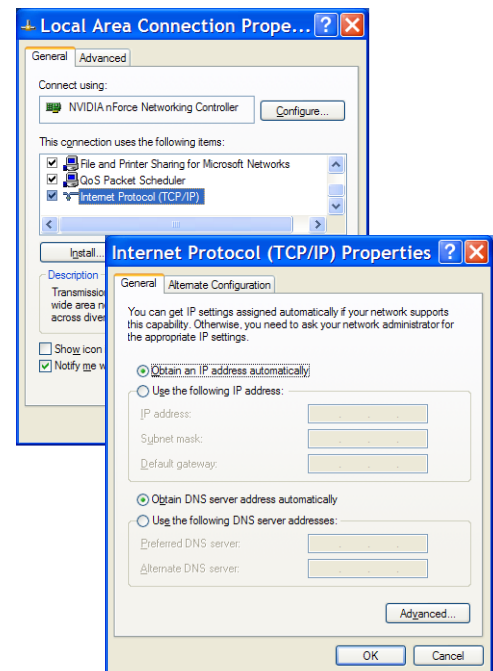

Commissioning

Notice!



The LES 36/PB PROFIBUS device type is configured as all variants are, via Ethernet through the **LESsoft** software. LES 36/PB PROFIBUS device type commissioning notices can be found at the end of this document and in the technical description.

1. Configuring the LES - see chapter 8 of the Technical Description.
2. Programming process control - see chapter 9 of the Technical Description.
- or
3. Connecting the switching inputs and outputs accordingly - see chapter 6 of the Technical Description.
4. Adapt the IP configuration of the LES via the display in such a way that it can communicate with LESsoft.
Here you can change network address and associated net mask as well as the ports via which the LES communicates with process control. The values set via the display are not accepted immediately; they are not effective until the sensor is switched on again.
5. You can check the connection by entering the IP address data into **LESsoft** in the IP Configuration area and clicking on the **Check Connectivity** button.

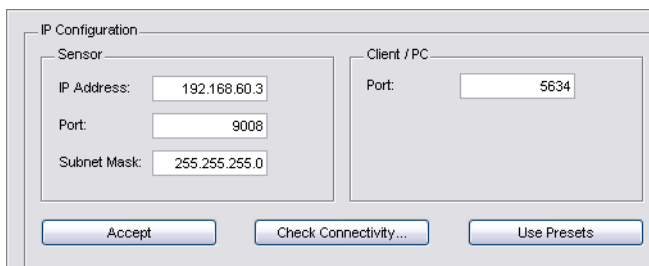

6. Configure LES with **LESsoft**.
7. Connect LES to the process control.
8. Establish connections for activation, triggering and cascading, if necessary.

Installing the configuration software

System requirements

The PC used should meet the following requirements:

- Pentium® or faster Intel® processor > 1.5 GHz (Pentium 4, Celeron, Xeon) or compatible models by AMD® (Athlon 64, Opteron, Sempron). The processor must support the SSE2 instruction set.
- At least 512 MB free main memory (RAM), 1024 MB recommended.
- CD-ROM drive.
- Hard disk with at least 1 GB available memory.
- Ethernet port.
- Microsoft® Windows XP SP2/3 / Vista SP1 (32 bit).

Installation procedure

Notice!



If present, *uninstall* Matlab Runtime *before beginning with the installation of the LXSoft Suite.*

The LXSoft_Suite_Setup.exe installation program is located on the supplied CD.



Notice!

Copy this file from the CD to an appropriate folder on your hard drive.

Administrator privileges are required for the next steps.

- ☞ To start the installation process, double-click on file LXSSoft_Suite_Setup.exe.
- ☞ In the first window, click on Next.

In the next window, you can select whether you would like to install **LESsoft** only, or **LPSsoft** and **LRSsoft** in addition.

You will need **LPSsoft** and **LRSsoft** in addition for configuring light section sensors of the LPS or LRS series with your PC.

- ☞ Select the desired options and click on Next and, in the next window, click on Install.

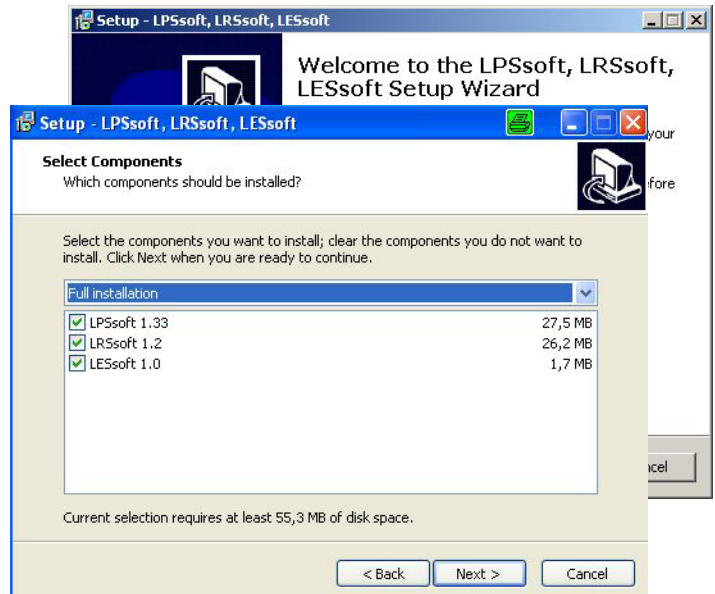

The installation routine starts. After a few seconds, the window for selecting the installation language for the Matlab Compiler Runtime (MCR) appears. The MCR is used for 3D visualization. It is only available in English or Japanese.

- ☞ Therefore keep in the Choose Setup Language window the selection English and click on OK.

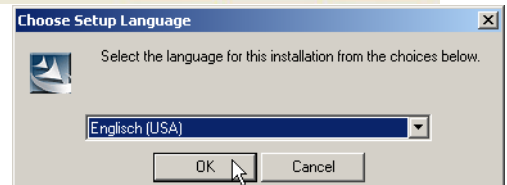

Depending on the configuration of your Windows system the adjacent dialog can also appear (missing component VCREDIST_X86).

- ☞ Click on Install

Two additional installation windows will appear, which do not require any further entry.

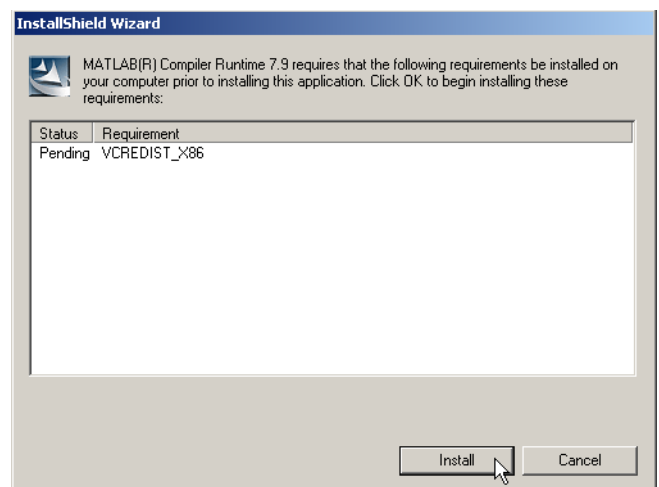

LES 36

Light section sensor for object measurement

After some time (up to several minutes depending on the system configuration) the start screen of the MCR installer will appear.

☞ *Click on Next.*

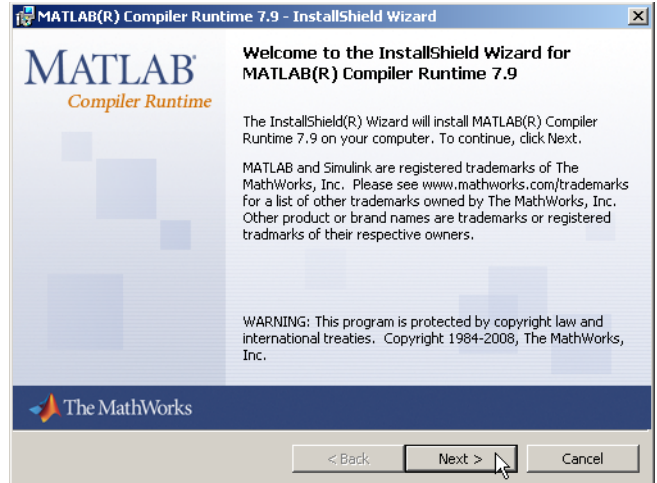

The window for entering user data appears.

☞ *Enter your name and the company name and then click on Next.*

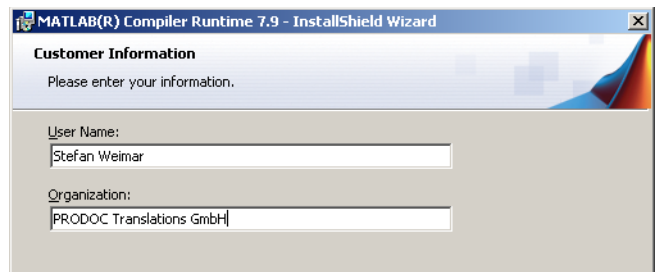

☞ *It is essential that you retain the default folder in the window for the selection of the installation path (Destination Folder).*

The standard path is

C:\Programs\MATLAB\MATLAB Compiler Runtime\.

☞ *Click on Next and in the next window click on Install.*

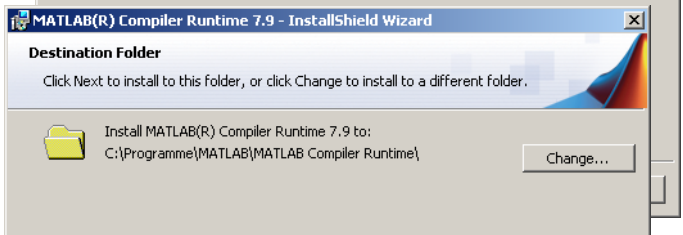

The installation will start and the adjacent status window will be displayed. This can again take several minutes.

Following successful MCR installation, the InstallShield Wizard Completed window appears.

☞ *Click on Finish to end the MCR-installation.*

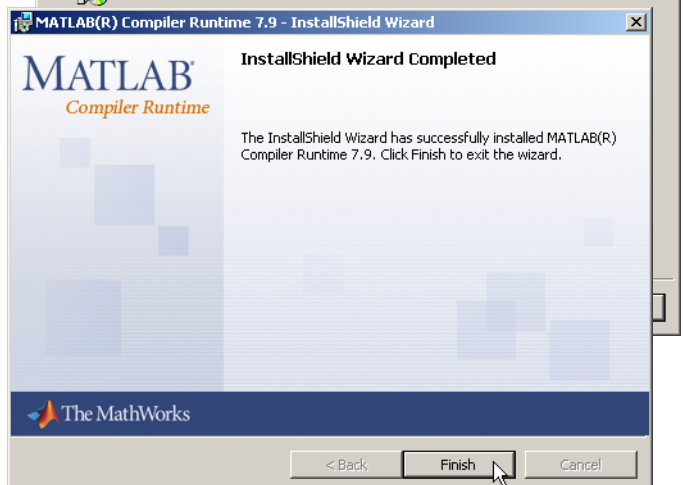

The window for selecting the installation path for **LESsoft** now appears.

☞ *Keep the default folder and click on Next.*

The installation of **LESsoft** starts. If you also selected **LPSsoft** and **LRSsoft** for installation, upon completion of the **LESsoft** installation, the same window then reappears for entering the installation path for **LPSsoft** and **LRSsoft**.

☞ *Keep the default folder in this case as well and click on Next.*



Upon completion of the installation process, the adjacent window appears.

The installation routine added a new **Leuze electronic** program group in your start menu that contains the installed programs **LESsoft** and, if selected, **LPSsoft** and **LRSsoft**.

☞ *Click on Finish and then start the desired program from the Start menu.*

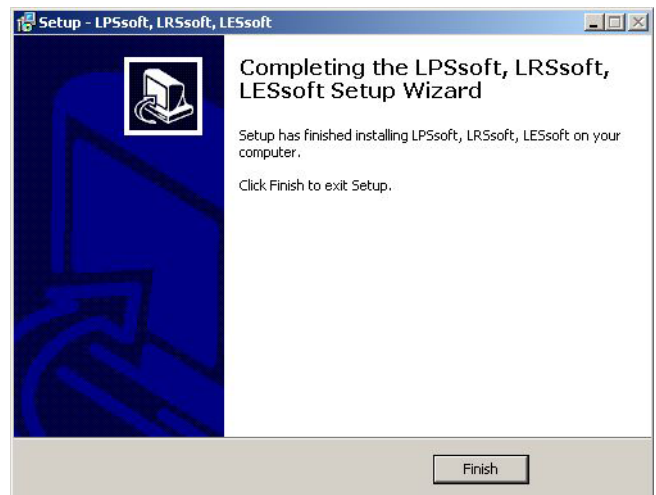

LES 36

Light section sensor for object measurement

Possible error message

Depending on the system configuration the adjacent error message can appear at this point.

The cause of this error message is a bug in the MCR installation routine, which does not set the environment variable `Path` correctly in some systems.



That, however, can easily be corrected without reinstallation of the MCR.

➤ *Open the System properties window located in the System control of Windows under System.*

➤ *Go to the Advanced tab and click on Environment variables.*

The Environment variables window opens.

➤ *Scroll down in the System variables area until you find the Path entry.*

➤ *Click on Path and then on Edit.*

The Edit system variable window opens.

There in the Variable value field you will find the `;C:\Programs\MATLAB\MATLAB Compiler Runtime\v79\runtime\win32` entry right at the end.

➤ *If this entry is missing, copy the entry from this document and insert it together with the preceding semi-colon.*

➤ *Then click on OK and close also all further windows using OK.*

➤ *Shut Windows down, restart Windows and then start LESsoft by double-clicking on it.*

Now the start screen of **LESsoft** appears, as described in chapter 8 of the LES technical description.

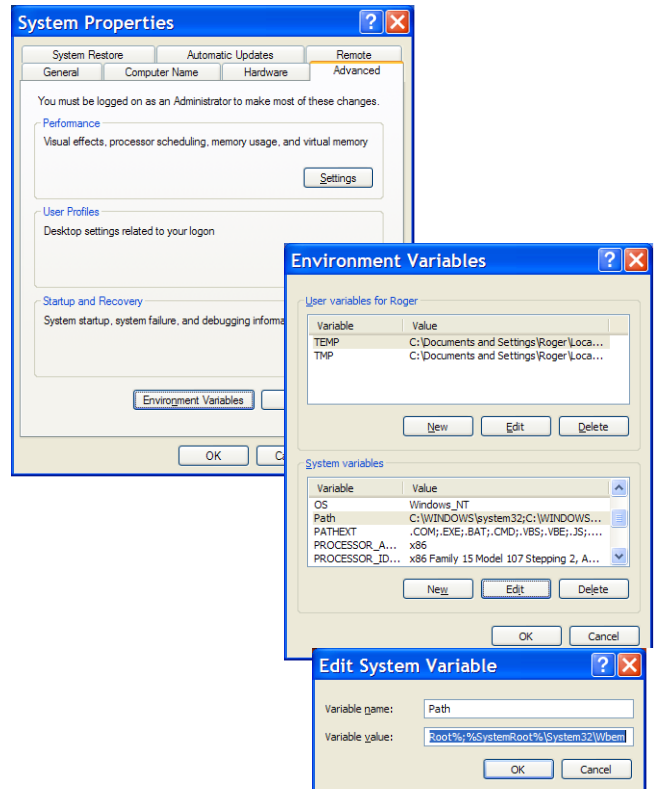

LES 36/PB PROFIBUS device type

General Information - Technical characteristics

The sensor is configured as all device variants are, via the **LESsoft** configuration software.

The LES 36/PB is designed as a PROFIBUS DP/DPV1 compatible slave. The input/output functionality of the sensor is defined by the corresponding GSD file. The baud rate of the data to be transmitted is max. 6MBit/s under production conditions.

Setting of the PROFIBUS address:

The LES 36/PB supports the automatic detection of the baud rate and the automatic address assignment via the PROFIBUS. Alternatively, the PROFIBUS address can be set via the display and the key pad or via the **LESsoft** configuration software.

PROFIBUS connection

Connection to the PROFIBUS is done via the **X4** 5-pin M12 socket with an **external Y plug adapter**. The assignment corresponds to the PROFIBUS standard. The Y plug adapter makes possible the exchange of the LES 36/PB without interrupting the PROFIBUS cable. The external Y plug adapter is also needed when the LES 36/PB is the last network device. Then the external bus terminating resistor (termination) is connected to it. The 5V supply of the active termination is applied to **X4** (pin 1). **This is then further looped only via the outgoing side** of the Y plug adapter.

Simultaneous operation on Ethernet and PROFIBUS

- Ethernet and PROFIBUS can be used in measure mode as fully-fledged interfaces.
- If the sensor is configured with **LESsoft** and simultaneously operated on PROFIBUS, queries from the control are processed and the process data is updated with a delay (indicated by slowly increasing scan numbers). Process data is updated every 200ms.

During configuration of the LES 36/PB with **LESsoft**, it must be determined whether the PROFIBUS or **LESsoft** may perform the changeover of the inspection task. This is set with the **Enable external inspection task selection** checkbox.

 **Notice!**

 When **LESsoft** has established a connection to LES 36/PB, the software switches the sensor into configuration mode. The update rate is max. 5Hz. If the sensor is in free running mode, the flashing of the laser beam indicates this.

- If the sensor is in menu mode or command mode, communication via PROFIBUS is possible. Queries from the control are not processed and the process data is frozen (indicated by the constant scan number).

General information about the GSD file

The functionality of sensor inputs/outputs for the control is defined via a module. The necessary module is integrated via a user-specific configuration tool during PLC program creation and configured corresponding to the application.

The short form of the module description is included in this data sheet. Please refer to the technical documentation for the detailed description.

 **Notice!**

 A module from the GSD file must be activated in the configuration tool of the control, module M1, M2 or M3.

Parameters can be changed via the display for test purposes on a LES 36/PB operating on the PROFIBUS. At this time, object measurement on PROFIBUS is not possible.

 **Notice!**

 All input and output modules described in the documentation are described **from the viewpoint of the control:**
Inputs (I) described are inputs of the control.
Outputs (O) described are outputs of the control.
Parameters (P) described are parameters of the GSD file in the control.

The LES 36/PB has a module slot. With the selection of the corresponding module from the GSD, the process data of the LES 36/PB to be transmitted is set. A selection of several modules is available. Beginning with **M1**, the simplest input module, new inputs are added to subsequent modules. All available output data is already included in module **M1**. The modules with higher numbers each contain the modules with lower numbers (example: **M2** contains **M1** and the extensions of **M2**).

 **Notice!**

 As the module number increases, so do the user data bytes to be transmitted.
 The maximal measurement rate of 100Hz can only be guaranteed up to module **M2**.

Therefore, only modules which contain the data actually required should be selected, i.e. the smallest possible module number should be selected.

LES 36
Light section sensor for object measurement
Overview of the modules in the GSD file LEUZE403.GSD
Output data (from viewing position of control)

Position	Name	Bits in byte								Value range	Meaning
		Bit7	Bit6	Bit5	Bit4	Bit3	Bit2	Bit1	Bit0		
0	uTrigger	Trig_7	Trig_6	Trig_5	Trig_4	Trig_3	Trig_2	Trig_1	Trig_0	0 ... 255	Triggering via PROFIBUS (in the case of changes)
1	uActivation	-	-	-	-	-	-	-	Act_0n	0 ... 1	Activation (=1) or deactivation (=0) of the sensor
2	ulnspTask	-	-	-	-	IT_b3	IT_b2	IT_b1	IT_b0	0 ... 15	Inspection task of PROFIBUS master and save flag (B7)

Input data (from viewing position of control)

GSE Module	Position (bytes)	Name	Bits in byte								Value range	Meaning	
			Bit7	Bit6	Bit5	Bit4	Bit3	Bit2	Bit1	Bit0			
M3 - 22 bytes	M1 - 8 bytes	0	wScanNum (HighByte)	SN_b15	SN_b14	SN_b13	SN_b12	SN_b11	SN_b10	SN_b9	SN_b8	0 ... 255	Scan number (HighByte)
		1	wScanNum (LowByte)	SN_b7	SN_b6	SN_b5	SN_b4	SN_b3	SN_b2	SN_b1	SN_b0	0 ... 255	Scan number (LowByte)
		2	uSensorInfo	Edge4	Edge3	Edge2	Edge1	IT_b3	IT_b2	IT_b1	IT_b0	0 ... 255	SensorInfo (edge detection state, inspection task no.)
		3	uSensorState	ErrM	Cmd	Menu	Meas	ErrF	WarnF	active	connect	0 ... 255	sensor state
		4	uResultEdge/Logic	LEAW4	LEAW3	LEAW2	LEAW1	DAW4	DAW3	DAW2	DAW1	0 ... 255	Obj. Point/EAW state 1...4, AW Logic Ana. Depth 1...4
		5	uResultAWs	AW08	AW07	AW06	AW05	EAW4	EAW3	EAW2	EAW1	0 ... 255	State of AW05...AW08 and EAW1...EAW4
		6	wEdgeAW1Data1 (HighByte)	sign	OP_b14	OP_b13	OP_b12	OP_b11	OP_b10	OP_b9	OP_b8	-32768 ... +32767	Signed measurement value 1 in the EAW1 edge analysis window
		7	wEdgeAW1Data1 (LowByte)	OP_b7	OP_b6	OP_b5	OP_b4	OP_b3	OP_b2	OP_b1	OP_b0	-32768 ... +32767	Signed measurement value 2 in the EAW1 edge analysis window
	M3 - 16 bytes	8	wEdgeAW1Data2 (HighByte)	sign	OP_b14	OP_b13	OP_b12	OP_b11	OP_b10	OP_b9	OP_b8	-32768 ... +32767	Signed measurement value 2 in the EAW1 edge analysis window
		9	wEdgeAW1Data2 (LowByte)	OP_b7	OP_b6	OP_b5	OP_b4	OP_b3	OP_b2	OP_b1	OP_b0	-32768 ... +32767	Signed measurement value 1 in the EAW2 edge analysis window
		10	wEdgeAW2Data1 (HighByte)	sign	OP_b14	OP_b13	OP_b12	OP_b11	OP_b10	OP_b9	OP_b8	-32768 ... +32767	Signed measurement value 1 in the EAW2 edge analysis window
		11	wEdgeAW2Data1 (LowByte)	OP_b7	OP_b6	OP_b5	OP_b4	OP_b3	OP_b2	OP_b1	OP_b0	-32768 ... +32767	Signed measurement value 2 in the EAW2 edge analysis window
		12	wEdgeAW2Data2 (HighByte)	sign	OP_b14	OP_b13	OP_b12	OP_b11	OP_b10	OP_b9	OP_b8	-32768 ... +32767	Signed measurement value 2 in the EAW2 edge analysis window
		13	wEdgeAW2Data2 (LowByte)	OP_b7	OP_b6	OP_b5	OP_b4	OP_b3	OP_b2	OP_b1	OP_b0	-32768 ... +32767	Signed measurement value 1 in the EAW3 edge analysis window
		14	wEdgeAW3Data1 (HighByte)	sign	OP_b14	OP_b13	OP_b12	OP_b11	OP_b10	OP_b9	OP_b8	-32768 ... +32767	Signed measurement value 1 in the EAW3 edge analysis window
		15	wEdgeAW3Data1 (LowByte)	OP_b7	OP_b6	OP_b5	OP_b4	OP_b3	OP_b2	OP_b1	OP_b0	-32768 ... +32767	Signed measurement value 2 in the EAW3 edge analysis window
		16	wEdgeAW3Data2 (HighByte)	sign	OP_b14	OP_b13	OP_b12	OP_b11	OP_b10	OP_b9	OP_b8	-32768 ... +32767	Signed measurement value 2 in the EAW3 edge analysis window
		17	wEdgeAW3Data2 (LowByte)	OP_b7	OP_b6	OP_b5	OP_b4	OP_b3	OP_b2	OP_b1	OP_b0	-32768 ... +32767	Signed measurement value 1 in the EAW4 edge analysis window
		18	wEdgeAW4Data1 (HighByte)	sign	OP_b14	OP_b13	OP_b12	OP_b11	OP_b10	OP_b9	OP_b8	-32768 ... +32767	Signed measurement value 1 in the EAW4 edge analysis window
		19	wEdgeAW4Data1 (LowByte)	OP_b7	OP_b6	OP_b5	OP_b4	OP_b3	OP_b2	OP_b1	OP_b0	-32768 ... +32767	Signed measurement value 2 in the EAW4 edge analysis window
		20	wEdgeAW4Data2 (HighByte)	sign	OP_b14	OP_b13	OP_b12	OP_b11	OP_b10	OP_b9	OP_b8	-32768 ... +32767	Signed measurement value 2 in the EAW4 edge analysis window
21	wEdgeAW4Data2 (LowByte)	OP_b7	OP_b6	OP_b5	OP_b4	OP_b3	OP_b2	OP_b1	OP_b0	-32768 ... +32767	Signed measurement value 1 in the EAW4 edge analysis window		

You can find detailed information in the technical description of the LES 36.

PROFIBUS accessories

Ready-made cables with M12 connector and open end

M12 socket
(B coded)

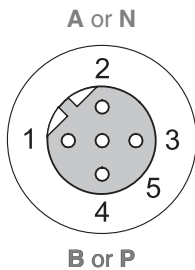

M12 connector
(B coded)

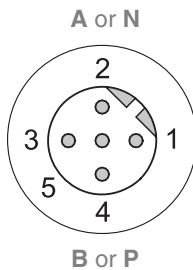

Contact	Signal	Color
M12 connector		
M12 socket		
1	n.c.	
2	A / N	green
3	n.c.	
4	B / P	red
5	n.c.	
Screw connection	Shield	bright

Part no.	Type designation	Description
50104181	KB PB-2000-BA	M12 socket for BUS IN, axial connector, open cable end, cable length 2m
50104180	KB PB-5000-BA	M12 socket for BUS IN, axial connector, open cable end, cable length 5m
50104179	KB PB-10000-BA	M12 socket for BUS IN, axial connector, open cable end, cable length 10m
50104188	KB PB-2000-SA	M12 connector for BUS OUT, axial connector, open cable end, cable length 2m
50104187	KB PB-5000-SA	M12 connector for BUS OUT, axial connector, open cable end, cable length 5m
50104186	KB PB-10000-SA	M12 connector for BUS OUT, axial connector, open cable end, cable length 10m
50104097	KB PB-2000-SBA	M12 connector + M12 socket for PROFIBUS, axial connector, cable length 2m
50104098	KB PB-5000-SBA	M12 connector + M12 socket for PROFIBUS, axial connector, cable length 5m
50104099	KB PB-10000-SBA	M12 connector + M12 socket for PROFIBUS, axial connector, cable length 10m

PROFIBUS terminating resistor

Part no.	Type designation	Description
50038539	TS 02-4-SA M12	M12 connector with integrated terminating resistor for BUS OUT

PROFIBUS Y plug adapter

Part no.	Type designation	Description
50109834	KDS BUS OUT M12-T-5P	M12 T-connector for BUS OUT

PROFIBUS GSD file



Notice!

The current version of the GSD file **LEUZE403.GSD** for the LES 36/PB can be found on the Leuze website at **Download -> detect -> Measuring sensors**.