

**ODSL 96**

**Optical laser distance sensors**

en 07-2011/12 50103924-01



**Dimensioned drawing**

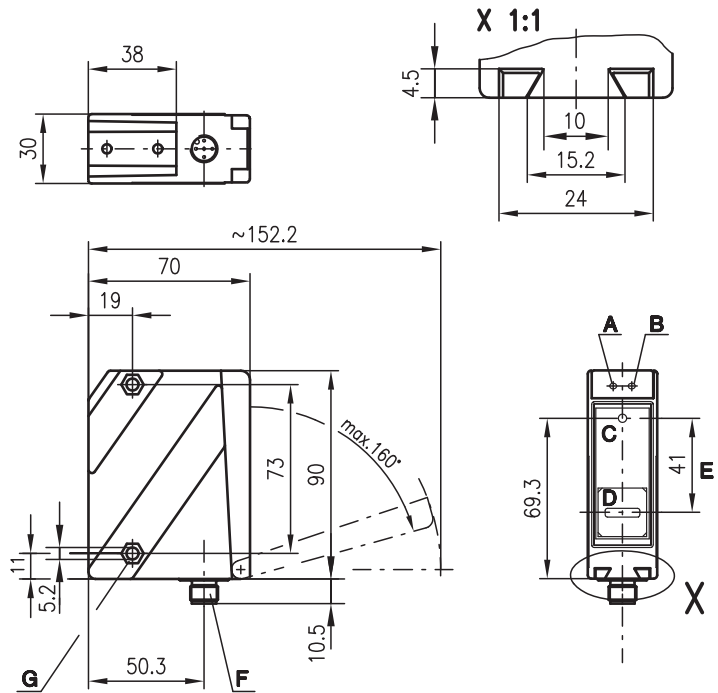

- A Green indicator diode
- B Indicator diode yellow
- C Transmitter
- D Receiver
- E Optical axis
- F Device plug M12x1
- G Countersinking for SK nut M5, 4.2mm deep
- H Teach button



**150 ... 2300mm**



- Reflection-independent distance information
- Analog voltage output 1 ... 10V (can be inverted, teachable)
- 2 teachable switching outputs (push-pull)
- Easy alignment through visible red light

**Electrical connection**

ODSL 96K/V66-2300-S12

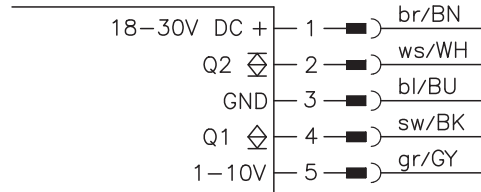

**Accessories:**

(available separately)

- Mounting systems
- Cable with M12 connector (K-D ...)

We reserve the right to make changes • ODSL96K\_V66\_2300\_S12\_en.fm



## Specifications

### Optical data

Measurement range <sup>1)</sup>	150 ... 2300mm
Resolution <sup>2)</sup>	1 ... 5mm
Light source	laser
Wavelength	650nm (visible red light)
Max. output power	<1.2 mW
Pulse duration	4ms
Light spot	divergent, 3x8mm <sup>2</sup> at 2300mm
Laser warning notice	see remarks

### Error limits (relative to measurement distance)

Absolute measurement accuracy <sup>1)</sup>	± 3%
Repeatability <sup>3)</sup>	± 2%
B/W detection thresh. (6 ... 90% rem.)	≤ 1%
Temperature drift	≤ 0.1%/°C

### Timing

Measurement time	2 ... 7ms
Response time	≤ 20ms
Delay before start-up	≤ 300ms

### Electrical data

Operating voltage $U_B$	18 ... 30VDC (incl. residual ripple)
Residual ripple	≤ 15% of $U_B$
Open-circuit current	≤ 150mA
Switching output/function <sup>4)</sup>	2 push-pull switching outputs pin 2: Q2, PNP light switching, NPN dark switching pin 4: Q1, PNP light switching, NPN dark switching
Signal voltage high/low	≥ ( $U_B - 2V$ ) ≤ 2V
Analog output	voltage 1 ... 10V, $R_L \geq 2k\Omega$

### Indicators

Green LED	continuous light flashing (no teach) off	ready fault, teach values were not applied no voltage
Yellow LED	continuous light flashing (no teach) off	object within teach-in measurement distance (output Q1 <sup>5)</sup> teach values were not applied object outside teach-in measurement distance (output Q1 <sup>4)</sup>

### Mechanical data

Housing	plastic
Optics cover	plastic
Weight	140g
Connection type	M12 connector

### Environmental data

Ambient temp. (operation/storage)	-20°C ... +40°C / -30°C ... +70°C
Protective circuit <sup>6)</sup>	1, 2, 3
VDE safety class <sup>7)</sup>	II, all-insulated
Protection class	IP 67
Laser class	2 (acc. to EN 60825-1)
Standards applied	IEC 60947-5-2

- 1) Luminosity coefficient 6% ... 90%, at 20°C, measurement object ≥ 50x50mm<sup>2</sup>
- 2) Minimum and maximum value depend on measurement distance and configuration of the analog output
- 3) Same object, identical environmental conditions, measurement object ≥ 50x50mm<sup>2</sup>
- 4) The push-pull switching outputs must not be connected in parallel
- 5) No display for output Q2
- 6) 1=transient protection, 2=polarity reversal protection, 3=short circuit protection for all outputs
- 7) Rating voltage 250VAC

Characteristic curve of analog output:

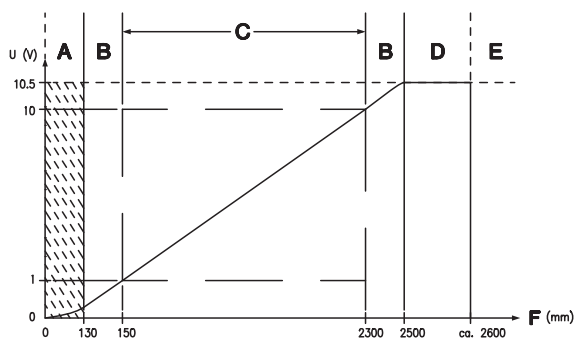

- A Area not defined
- B Linearity not defined
- C Measurement range
- D Object present
- E No object detected
- F Measurement distance

## Order guide

	Designation	Part no.
With M12 connector and analog output	ODSL 96K/V 66-2300-S12	50101881

## Tables

## Diagrams

Characteristic curve of switching outputs:

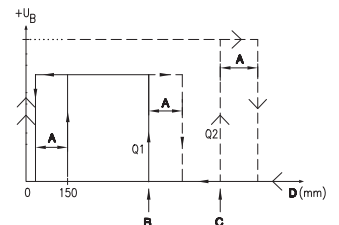

- A Hysteresis
- B Switching point Q1 (teach point)
- C Switching point Q2 (teach point)
- D Measurement distance

## Remarks

- Measurement time depends on the reflectivity of the measurement object and on the measurement mode.
- **Approved purpose:** The ODSL 96 distance sensors are optoelectronic sensors for the optical, contactless measurement of distance to objects.

**T<sub>1</sub> teach-in with teach button**

1. Position measurement object at the desired measurement distance (①).

2. The respective teach function is activated by operating the teach button (②) for different amounts of time. The activated teach function is signaled by a flashing of the LEDs.

Teach function	Duration of teach button operation	Green LED	Yellow LED
Switching output Q1	2 ... 4s	Flash synchronously	
Switching output Q2	4 ... 6s	Flash synchronously	
1V analog output	6 ... 8s	On	Flashes
10V analog output	8 ... 10s	Flashes	On

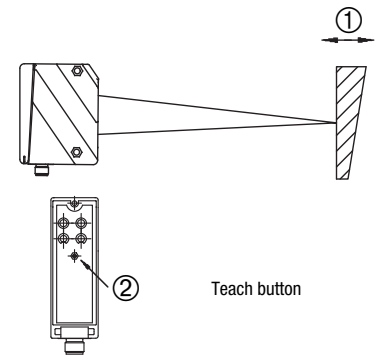

3. Release teach button (②) and wait for optical confirmation by end of flashing signal (green LED on).

**Reset of the analog output to factory settings**

**Reset 1V analog output at 150mm:**

1. Position measurement object just below start of measurement range (150mm).
2. Press teach button for 6 ... 8s (green LED on, yellow LED flashes).
3. Release teach button and wait for optical confirmation by end of flashing signal (green LED on).

**Reset 10V analog output at 2300mm:**

1. Position measurement object just beyond end of measurement range (2300mm).
2. Press teach button for 8 ... 10s (green LED flashes, yellow LED on).
3. Release teach button and wait for optical confirmation by end of flashing signal (green LED on).

**Error messages**

Continuously flashing LEDs signal an unsuccessful teach event (sensor not ready):

Green LED	Yellow LED	Error
Flash synchronously		Teach switching output Q1 unsuccessful
Flash alternatingly		Teach switching output Q1 unsuccessful
On	Flashes	Teach 1V analog output unsuccessful
Flashes	On	Teach 10V analog output unsuccessful

Remedy:

- Repeat teach event or
- Press teach button for more than 10s or
- Disconnect sensor from voltage to restore the old values.

**Typical areas of application of optical distance sensors**

Continuous distance measurement

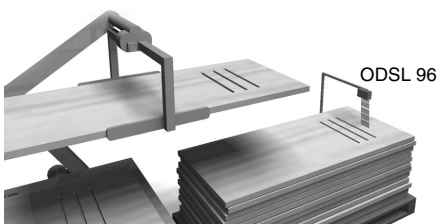

Positioning tasks

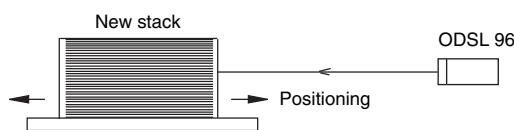

Filling level control

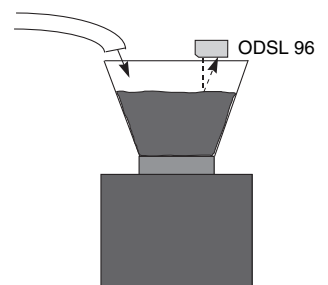

## Installation instructions

Mounting systems are available which have to be ordered separately at Leuze electronic. Apart from this, the drilled-through holes and threaded holes are suitable for the individual mounting of the ODSL 96, depending on the area in which it is used. When mounting, avoid application of excessive force on the housing.

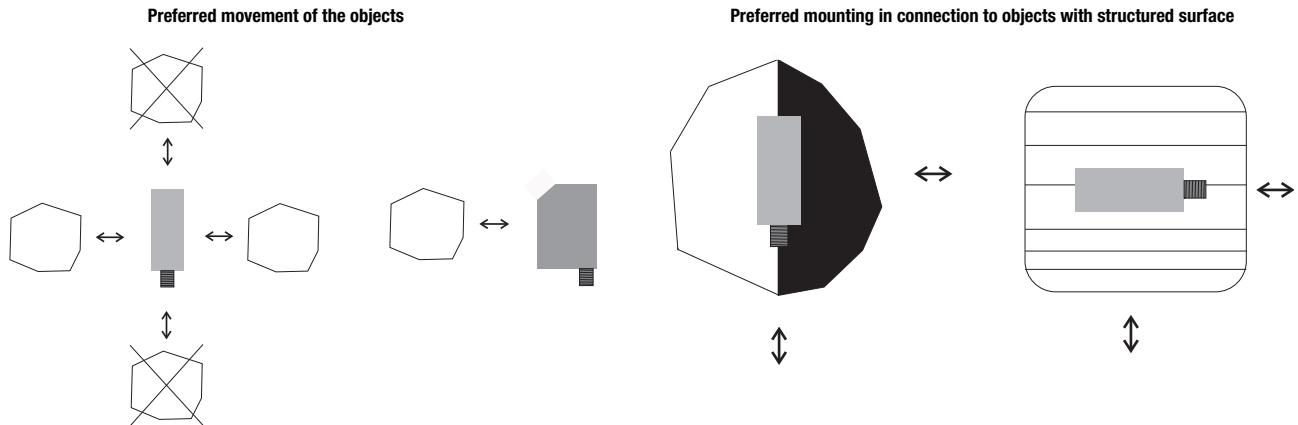

### View through a chase

If the ODSL 96 has to be installed behind a cover, the chase has to have at least the size of the optical glass cover. Otherwise, a correct measurement is not possible or can not be guaranteed.

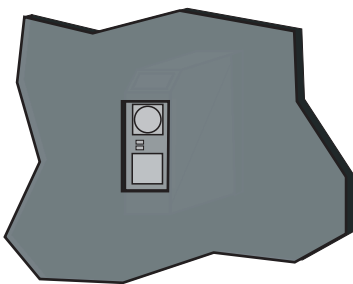

### Alignment to measurement objects with reflecting surfaces

If the measurement object to be detected has a reflecting surface, a measurement may not be possible depending on the angle in which the light is reflected by the measurement object's surface. Adjust the angle between the sensor and the measurement object such that the sensor can reliably detect the measurement object.

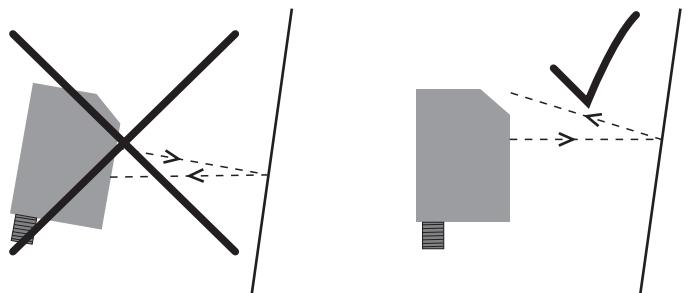

## Working safely



### Attention Laser Radiation!

**The optical distance sensors ODSL 96 operate with a red light laser of class 2 acc. to EN 60825-1. If you look into the beam path over a longer time period, the retina of your eye may be damaged!**

**Never look directly into the beam path! Do not point the laser beam of the ODSL 96 at persons!**

**When mounting and aligning the ODSL 96 take care to avoid reflections of the laser beam off reflective surfaces! The use of operating and adjusting devices other than those specified in the technical description, carrying out of differing procedures, or improper use of the optical laser distance sensor may lead to dangerous exposure to radiation!**

**The use of optical instruments or devices in combination with the device increases the danger of eye damage! Adhere to the applicable legal and local regulations regarding protection from laser beams acc. to EN 60825-1 in its latest version.**

**The ODSL 96 uses a laser diode with low power in the visible red light range with an emitted wavelength of about 635nm.**

**The glass optics cover is the only opening through which the laser radiation can escape from the device. The housing of the ODSL 96 is sealed and has no parts that need to be adjusted or maintained by the user. The device must not be tampered with and must not be changed in any way! The destruction of the seal voids the warranty!**



### Notice!

**It is important to attach the stick-on labels delivered with the device (notice signs)! If the signs could be covered due to the installation location of the ODSL 96, attach them close to the ODSL 96 so that it is not possible to look into the laser beam when reading the notices!**