

**PRK 3B**

**Retro-reflective photoelectric sensors with polarization filter**

en 10-2011/04 50105364



**Dimensioned drawing**

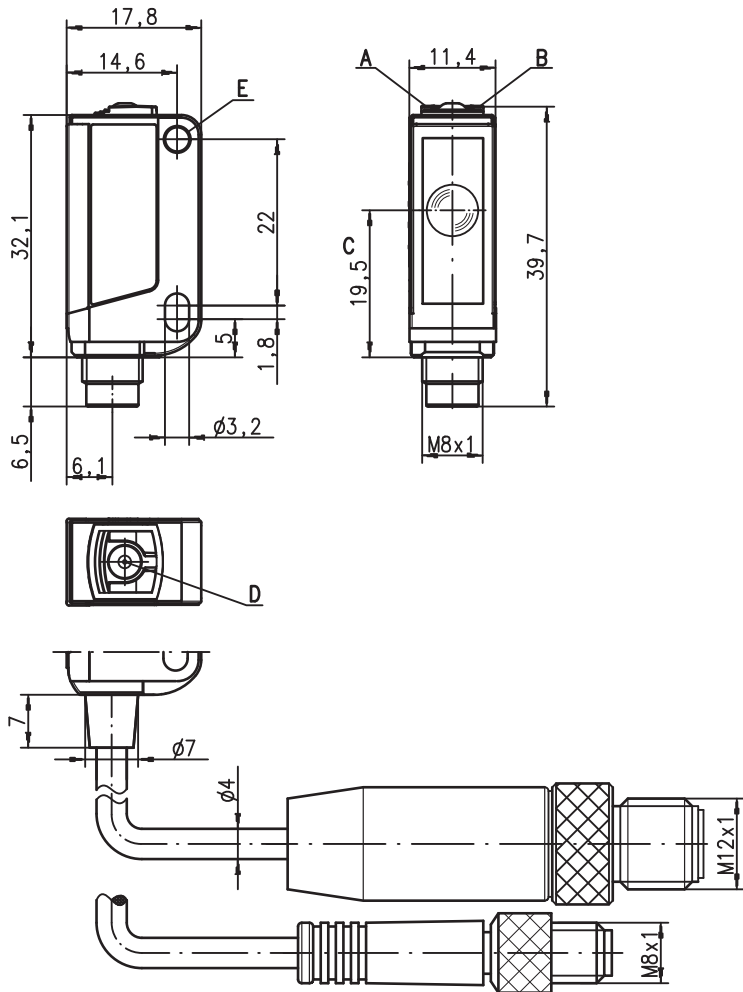

- A Green indicator diode
- B Yellow indicator diode
- C Optical axis
- D Teach button
- E Attachment sleeve

- Polarized retro-reflective photoelectric sensor, autocollimation optics with visible red light
- For precise positioning of objects and reflector markers
- Small and compact construction with robust plastic housing, protection class IP 67 for industrial application
- A²LS- Active Ambient Light Suppression
- Push-pull output with light/dark switching via teach-in button
- High switching frequency for detection of fast events
- Easy adjustment via lockable teach button or teach input

**Electrical connection**

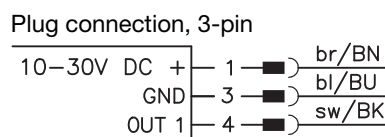
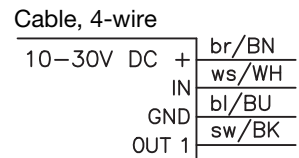
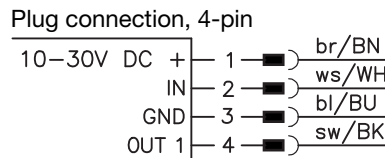

**Accessories:**

(available separately)

- Mounting systems (BT 3...)
- Cable with M8 or M12 connector (K-D ...)
- Reflectors
- Reflective tapes

We reserve the right to make changes • DS\_PRK3B\_Standard\_EL\_en.fm

## Specifications

### Optical data

Typ. op. range limit (TK(S) 100x100) <sup>1)</sup>	0 ... 5m
Operating range <sup>2)</sup>	see tables
Light source <sup>3)</sup>	LED (modulated light)
Wavelength	620nm (visible red light, polarized)

### Timing

Switching frequency	1,000Hz
Response time	0.5ms
Delay before start-up	≤ 300ms

### Electrical data

Operating voltage $U_B$ <sup>4)</sup>	10 ... 30VDC (incl. residual ripple)
Residual ripple	≤ 15% of $U_B$
Open-circuit current	≤ 18mA
Switching output <sup>5)</sup>	.../6.22 1 push-pull switching output pin 4: PNP light switching, NPN dark switching pin 2: teach input
	.../6D.22 1 push-pull switching output pin 4: PNP dark switching, NPN light switching pin 2: teach input
	.../6.22...-S8.3 1 push-pull switching output pin 4: PNP light switching, NPN dark switching pin 2: teach input
	.../4D.22 1 PNP switching output, dark switching, pin 2: teach input
Function characteristics	light/dark reversible
Signal voltage high/low	≥ ( $U_B - 2V$ )/≤ 2V
Output current	max. 100mA
Operating range	setting via teach-in

### Indicators

Green LED	ready
Yellow LED	light path free
Yellow LED, flashing	light path free, no performance reserve <sup>6)</sup>

### Mechanical data

Housing <sup>7)</sup>	plastic (PC-ABS); 1 attachment sleeve, nickel-plated steel
Optics cover	plastic (PMMA)
Weight	with connector: 10g with 200mm cable and connector: 20g with 2m cable: 50g
Connection type	2m cable (cross section 4x0.20mm <sup>2</sup> ), connector M8 metal, 0.2m cable with connector M8 or M12

### Environmental data

Ambient temp. (operation/storage)	-30°C ... +55°C/-30°C ... +70°C
Protective circuit <sup>8)</sup>	2, 3
VDE safety class	III
Protection class	IP 67
Light source	free group (in accordance with EN 62471)
Standards applied	IEC 60947-5-2
Certifications	UL 508 <sup>4)</sup>

### Options

#### Teach-in input/activation input

Transmitter active/not active	≥ 8V/≤ 2V
Activation/disable delay	≤ 1ms
Input resistance	30kΩ

- 1) Typ. operating range limit: max. attainable range without performance reserve
- 2) Operating range: recommended range with performance reserve
- 3) Average life expectancy 100,000h at an ambient temperature of 25°C
- 4) For UL applications: for use in class 2 circuits according to NEC only
- 5) The push-pull switching outputs must not be connected in parallel
- 6) Display "no performance reserve" as yellow flashing LED is only available in standard teach setting
- 7) Patent Pending Publ. No. US 7,476,848 B2
- 8) 2=polarity reversal protection, 3=short-circuit protection for all transistor outputs

## Remarks

Adapter plate:

BT 3.2 (part no. 50103844) for alternate mounting on 25.4mm hole spacing (Omron E3Z, Sick W100...)

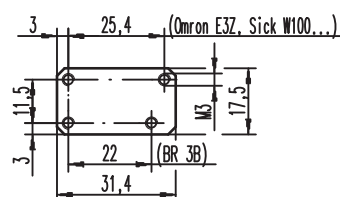

## Tables

Reflectors			Operating range
1	TK(S)	100x100	0 ... 4.0m
2	TK	40x60	0 ... 2.6m
3	TK	20x40	0 ... 1.3m
4	Tape 4	50x50	0 ... 0.7m

1	0		4	5
2	0	2,6	3,2	
3	0	1,3	1,5	
4	0	0,7	1,0	

□ Operating range [m]  
□ Typ. operating range limit [m]

TK ... = adhesive  
TKS ... = screw type

## Diagrams

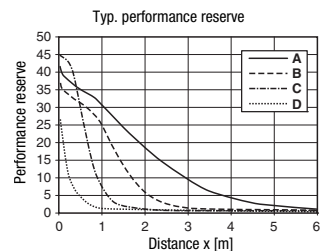
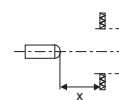
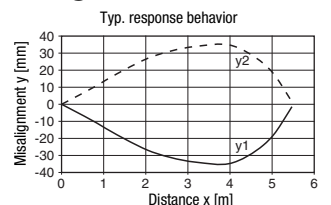

- A TK 100x100
- B TKS 40x60
- C TKS 20x40
- D Tape 4: 50x50

## Remarks

Mounting system:



- ① = BT 3 (part no. 50060511)
- ②+③ = BT 3.1 <sup>1)</sup> (part no. 50105585)
- ①+②+③ = BT 3B (part no. 50105546)

1) Packaging unit: PU = 10 pcs.

**PRK 3B Retro-reflective photoelectric sensors with polarization filter**

**Order guide**

Selection table			Order code →										
Equipment ↓			PRK 3B/6.22 Part No. 50104699	PRK 3B/6.22-S8 Part No. 50104700	PRK 3B/6.22, 200-S8 Part No. 50104701	PRK 3B/6.22, 200-S12 Part No. 50105762	PRK 3B/6D.22-S8 Part No. 50106418	PRK 3B/6.2-S8.3 Part No. 50109385	PRK 3B/6.2, 200-S8.3 Part No. 50114099	PRK 3B/6D.22.03, 200-S12 Part No. 50109488	PRK 3B/4D.22, 200-S8 Part No. 50110775	PRK 3B/4D.22Z, 200-S8 Part No. 50108373	
Output 1 (OUT 1)	push-pull switching output, configurable	light switching	● <sup>1)</sup>	● <sup>1)</sup>	● <sup>1)</sup>	● <sup>1)</sup>	●	● <sup>1)</sup>	● <sup>1)</sup>	●			
		dark switching	●	●	●	●	● <sup>1)</sup>	●	●	● <sup>1)</sup>			
	PNP transistor output	light switching	○										
		dark switching	●									● <sup>1)</sup>	● <sup>1)</sup>
	start-up delay (special function)											● <sup>2)</sup>	
Input (IN)	teach input		●	●	●	●	●			●	●	●	
	activation input												
Connection	cable 2,000mm	4-wire	●										
	M8 connector, metal	3-pin						●					
	M8 connector, metal	4-pin		●			●						
	200mm cable with M8 connector	3-pin							●				
	200mm cable with M8 connector	4-pin			●						●	●	
	200mm cable with M12 connector	4-pin				●				● <sup>3)</sup>			
Configuration	teach-in via button (lockable) and teach input		●	●	●	●	●			●	●	●	
	teach-in via button								●	●			

- 1) Presetting, light/dark switching, adjustable
- 2) Start-up delay (special function)  
The sensor output does not switch until an object has interrupted the light beam for at least 4 seconds. The output switches off without a time delay.
- 3) Connector without Ultra-Lock™ fast locking

**Approved purpose:**

This product may only be used by qualified personnel and must only be used for the approved purpose. This sensor is not a safety sensor and is not to be used for the protection of persons.

**Special function: start-up delay, only for PRK 3B/4D.22Z, 200-S8**

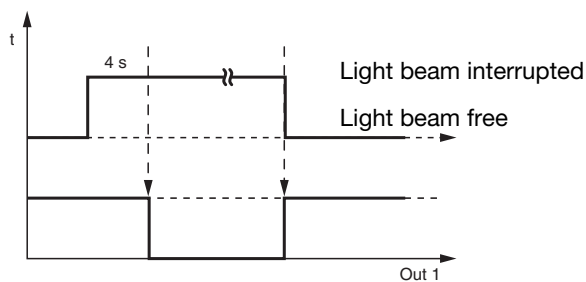

**Sensor adjustment (teach) via teach button**



- **The sensor is factory-adjusted for maximum operating range.**  
Recommendation: teach only if the desired objects are not reliably detected.
- **Prior to teaching: Clear the light path to the reflector!**  
The device setting is stored in a fail-safe way. A reconfiguration following voltage interruption or switch-off is thus not required.

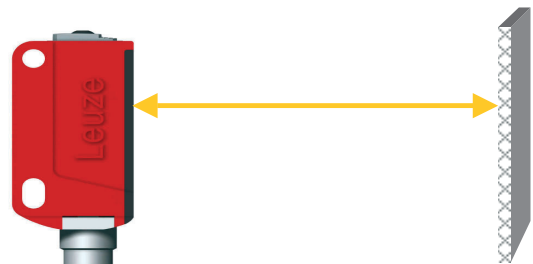

**Standard teaching for average sensor sensitivity**

- Press teach button until both LEDs flash **simultaneously**.
- Release teach button.
- Ready.



After the standard teaching, the sensor switches when half of the light beam is covered by the object.

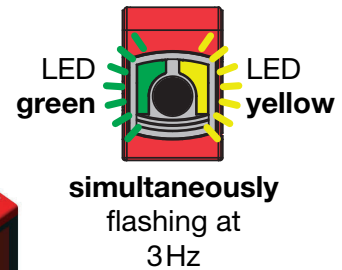
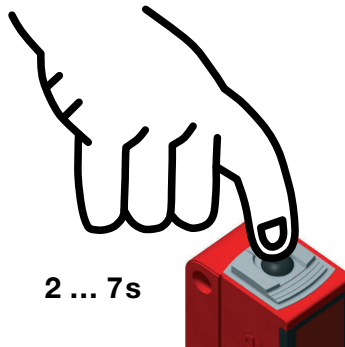

**Teaching for increased sensor sensitivity**

- Press teach button until both LEDs flash **alternatingly**.
- Release teach button.
- Ready.



After the teaching for increased sensor sensitivity, the sensor switches when about 18% of the light beam are covered by the object.

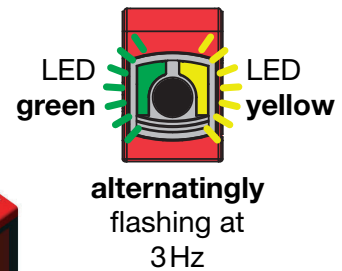
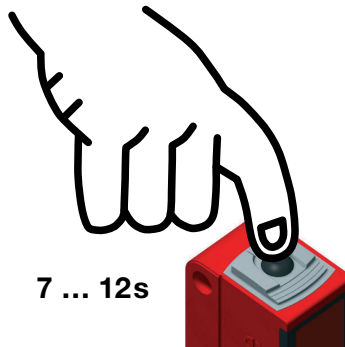

**Teaching for maximum operating range (factory setting at delivery)**

- **Prior to teaching:**  
Cover the light path to the reflector!
- Procedure as for standard teaching.

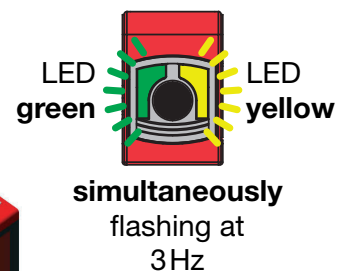
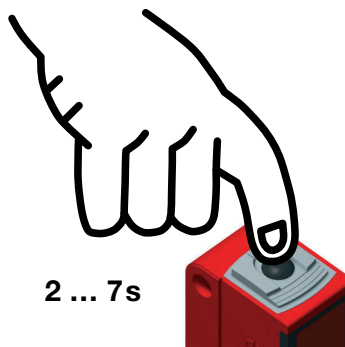
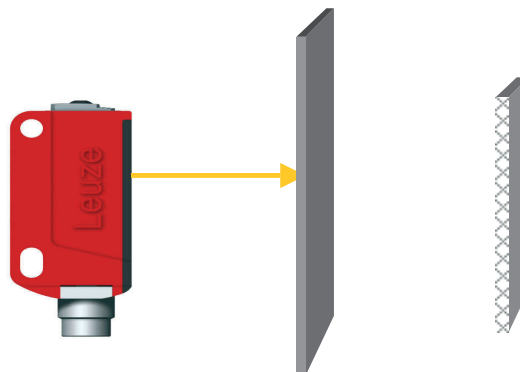

**PRK 3B Retro-reflective photoelectric sensors with polarization filter**

**Adjusting the switching behavior of the switching output – light/dark switching**

- Press teach button until the green LED flashes. The yellow LED displays the current setting of the switching output:  
**ON** = output switches on light  
**OFF** = output switches on dark
- Continue to press the teach button in order to change the switching behavior.
- Release teach button.
- Ready.

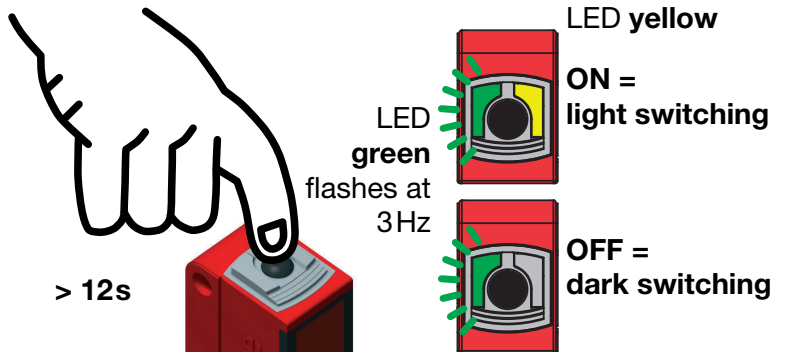

**Locking the teach button via the teach input**



A **static high signal** ( $\geq 4\text{ms}$ ) at the teach input locks the teach button on the device if required, such that no manual operation is possible (e.g., protection from erroneous operation or manipulation).

If the teach input is not connected or if there is a static low signal, the button is unlocked and can be operated freely.

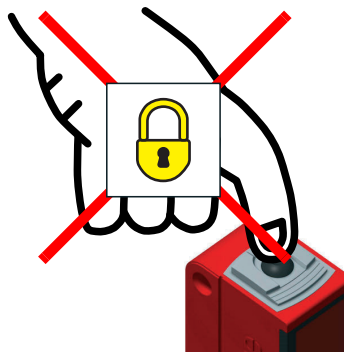

**Sensor adjustment (teach) via teach input**



The following description applies to PNP switching logic!

$U_{\text{Teach low}} \leq 2\text{V}$

$U_{\text{Teach high}} \geq (U_B - 2\text{V})$

**Prior to teaching: Clear the light path to the reflector!**

The device setting is stored in a fail-safe way. A reconfiguration following voltage interruption or switch-off is thus not required.

**Standard teaching for average sensor sensitivity**

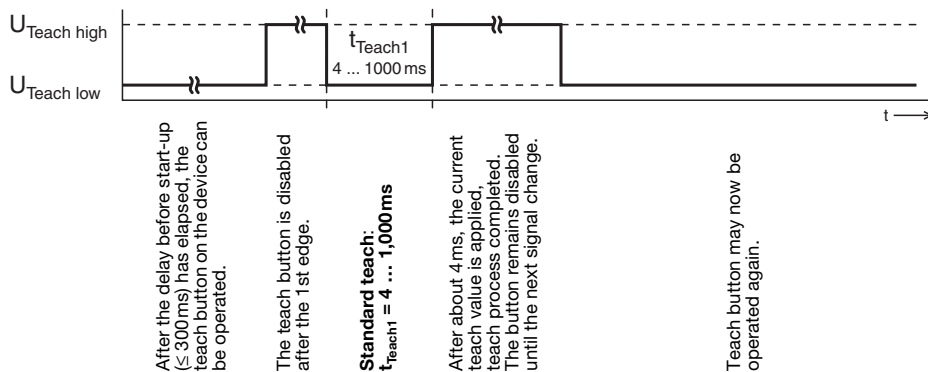

**Quick standard teach**

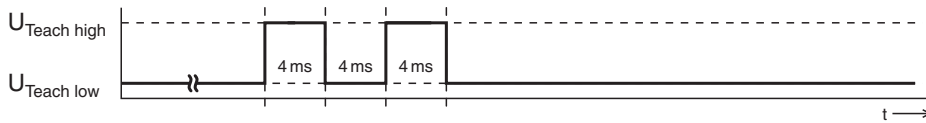

shortest teaching duration for standard teaching: approx. 12ms



After the standard teaching, the sensor switches when half of the light beam is covered by the object.

**Teaching for increased sensor sensitivity**

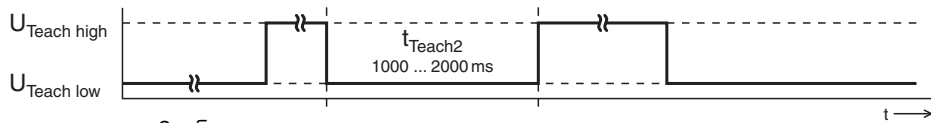

After the delay before start-up ( $\leq 300$ ms) has elapsed, the teach button on the device can be operated.

The teach button is disabled after the 1st edge.

Teach for increased sensor sensitivity:  
 $t_{Teach2} = 1,000 \dots 2,000$  ms

After about 4ms, the current teach value is applied, teach process completed. The button remains disabled until the next signal change.

Teach button may now be operated again.



After the teaching for increased sensor sensitivity, the sensor switches when about 18% of the light beam are covered by the object.

**Adjusting the switching behavior of the switching output – light/dark switching**

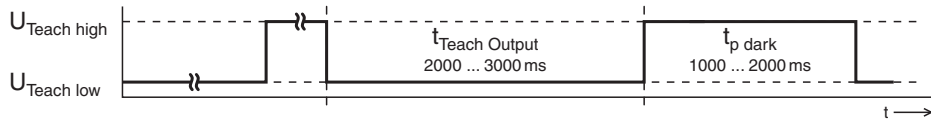
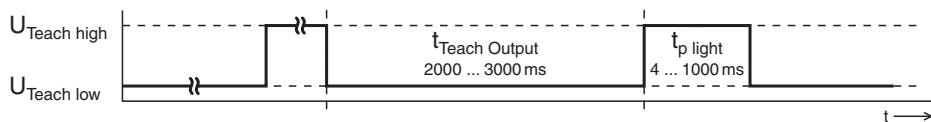

After the delay before start-up ( $\leq 300$ ms) has elapsed, the teach button on the device can be operated.

The teach button is disabled after the 1st edge.

Setting the switching behavior of the switching output:  
 $t_{Teach Output} = 2,000 \dots 3,000$  ms

Switching output switches on light:  
 $t_{p light} = 4 \dots 1,000$  ms

Switching output switches on dark:  
 $t_{p dark} = 1,000 \dots 2,000$  ms  
The button remains disabled until the next signal change.