

PRK 53

Retro-reflective photoelectric sensors with polarization filter

en 04-2013/01 50107824-01



Dimensioned drawing

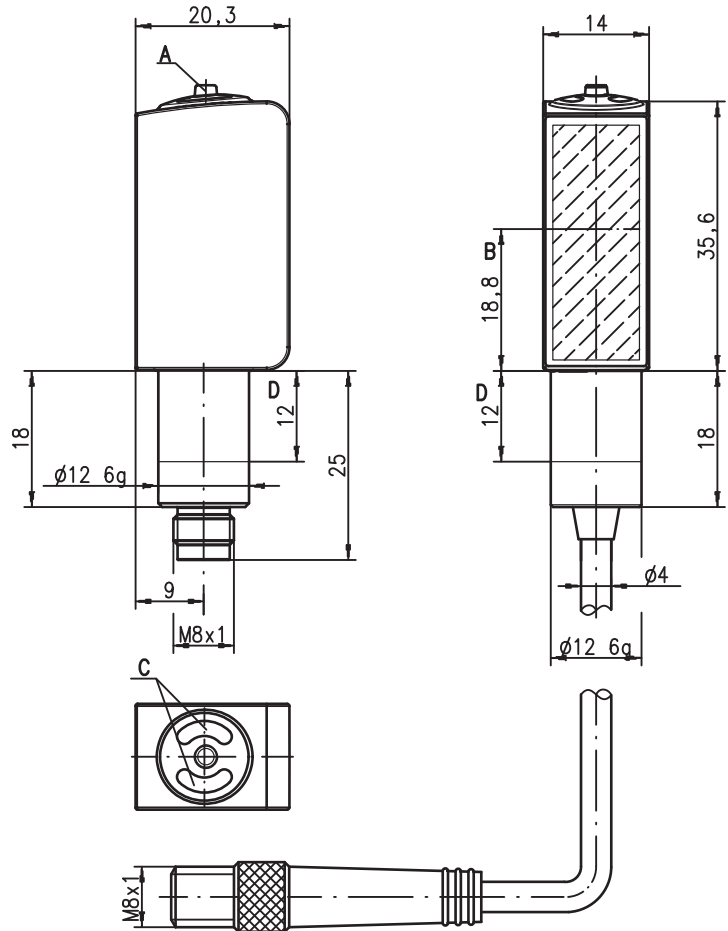

- A Teach button
- B Optical axis
- C Indicator diodes
- D Permissible clamping range

0 ... 5m
1 kHz
10 - 30 V DC
A²LS
stainless steel 316 L

- Polarized retro-reflective photoelectric sensor, autocollimation optics with visible red light
- 316L stainless steel housing in HYGIENE-Design
- Enclosed optics design prevents bacterial carry-overs
- ECOLAB and CleanProof+ tested
- Paperless device identification
- Scratch resistant and non-diffusive plastic front cover
- A²LS- Active Ambient Light Suppression
- High switching frequency for detection of fast events
- Easy adjustment via lockable teach button or teach input

Electrical connection

Plug connection, 4-pin (with/without cable)

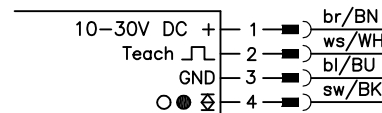

Connector, 3-pin

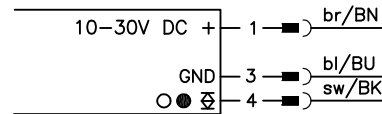

Cable, 4 wires

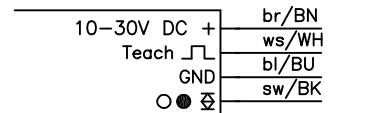

Accessories:

- (available separately)
- Cable with M8 or M12 connector (K-D ...)
 - Cable for food and beverages
 - Reflectors for the foods industry
 - Reflectors for the pharmaceutical industry
 - Reflective tapes
 - Mounting devices

We reserve the right to make changes • DS_PRK536_en_50107824-01.fm

Specifications

Optical data

Typ. op. range limit (TK(S) 100x100) ¹⁾ 0 ... 5m
 Operating range ²⁾ see tables
 Light source ³⁾ LED (modulated light)
 Wavelength 620nm (visible red light, polarized)

Timing

Switching frequency 1000Hz
 Response time 0.5ms
 Delay before start-up ≤ 300ms

Electrical data

Operating voltage U_B ⁴⁾ 10 ... 30VDC (incl. residual ripple)
 Residual ripple ≤ 15% of U_B
 Open-circuit current ≤ 18mA
 Switching output .../6.22 1 push-pull switching output
 pin 4: PNP light switching, NPN dark switching
 pin 2: teach input
 light/dark reversible
 Signal voltage high/low ≥ ($U_B - 2V$) ≤ 2V
 Output current max. 100mA
 Operating range setting via teach-in

Function characteristics
 Signal voltage high/low
 Output current
 Operating range

Indicators

LED green ready
 Yellow LED light path free
 Yellow LED, flashing light path free, no performance reserve ⁵⁾

Mechanical data

Housing AISI 316L stainless steel, DIN X2CrNiMo17132, W.No1.4404
 Housing design HYGIENE-Design
 Housing roughness ⁶⁾ $R_a \leq 2.5$
 Connector AISI 316L stainless steel, DIN X2CrNiMo17132, W.No1.4404
 Optics cover coated plastic (PMMA), scratch resistant and non-diffusive
 Operation plastic (TPV-PE), non-diffusive
 Weight with M8 connector: 50g
 with 200mm cable and M8 connector: 60g
 with 5000mm cable: 110g
 Connection type M8 connector, 4-pin or 3-pin,
 0.2m cable with M8 connector, 4-pin,
 5m cable, 4 x 0.20mm²
 via fit (see "Remarks")
 Fastening 3 Nm (permissible range, see dimensioned drawing)
 Max. tightening torque

Environmental data

Ambient temp. (operation/storage) ⁷⁾ -30°C ... +70°C / -30°C ... +70°C
 Protective circuit ⁸⁾ 2, 3
 VDE safety class ⁹⁾ III
 Protection class IP 67, IP 69K ¹⁰⁾
 Environmentally tested acc. to ECOLAB, CleanProof+
 LED class 1 (in accordance with EN 60825-1)
 Standards applied IEC 60947-5-2
 Certifications UL 508 ⁴⁾
 Chemical resistance tested in accordance with ECOLAB and CleanProof+ (see Remarks)

Options

Teach-in input/activation input

Transmitter active/not active ≥ 8V/≤ 2V
 Activation/disable delay ≤ 1ms
 Input resistance 30kΩ

- 1) Typ. operating range limit: max. attainable range without performance reserve
- 2) Operating range: recommended range with performance reserve
- 3) Average life expectancy 100,000h at an ambient temperature of 25°C
- 4) For UL applications: for use in class 2 circuits according to NEC only
- 5) Display "no performance reserve" as yellow flashing LED is only available in standard teach setting
- 6) Typical value for the stainless steel housing
- 7) Operating temperatures of +70°C permissible only briefly (≤ 15min)
- 8) 2=polarity reversal protection, 3=short circuit protection for all transistor outputs
- 9) Rating voltage 50V
- 10) Only with internal tube mounting of the M8 connector

Approved purpose

The photoelectric sensors are optical electronic sensors for optical, contactless detection of objects.

This product may only be used by qualified personnel and must only be used for the approved purpose. This sensor is not a safety sensor and is not to be used for the protection of persons.

Tables

Reflectors in food quality			Operating range
1	TK(S)	100x100	0 ... 4.0m
2	TK	40x60	0 ... 2.6m
3	Tape 6	50x50	0 ... 2.0m
4	TK	20x40	0 ... 1.3m
5	Tape 4	50x50	0 ... 0.7m

1	0			4	5
2	0	2.6	3.2		
3	0	2.0	2.4		
4	0	1.3	1.5		
5	0	0.7	1.0		

Pharmaceutical reflectors			Operating range
1	TK(S)	40x60.P	0 ... 1.6m
2	TK	BR53	0 ... 1.3m
3	TK(S)	20x40.P	0 ... 1.0m
4	TK(S)	20.P	0 ... 0.7m
5	MTK(S)	14x23.P	0 ... 0.4m
6	TK	10.P	0 ... 0.3m

1	0		1.6	1.8
2	0		1.3	1.6
3	0		1.0	1.2
4	0	0.7	0.8	
5	0	0.4	0.5	
6	0	0.3	0.4	

□ Operating range [m]
 ▨ Typ. operating range limit [m]

TK ... = adhesive
 TKS ... = screw type

Diagrams

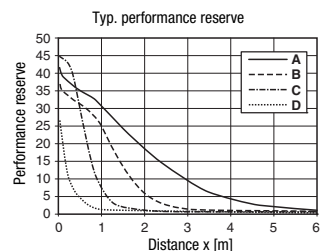
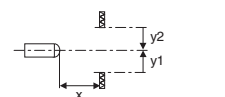
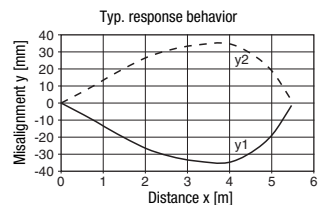

- A TK 100x100
- B TKS 40x60
- C TKS 20x40
- D Tape 4: 50x50

Remarks

A list of tested chemicals can be found in the first part of the product description.

Only secure in designated area using set screw. Max. tightening torque 3Nm.

PRK 53 **Retro-reflective photoelectric sensors with polarization filter**

Order guide

Selection table		Order code →			
Equipment ↓		PRK 53/6.22-S8 Part No. 50107603	PRK 53/6.22, 200-S8 Part No. 50105789	PRK 53/6.22-S8.3 Part No. 50107604	PRK 53/6.22-5000 Part no. 50121898
Switching output	1 x push-pull switching output	●	●	●	●
Switching function	light/dark switching configurable	●	●	●	●
Connection	M8 connector, metal, 4-pin	●			
	M8 connector, metal, 3-pin			●	
	cable 200mm with M8 connector, 4-pin		●		
	cable 5000mm, 4-wire				●
Configuration	teach-in via button (lockable) and teach input ¹⁾	●	●	●	●
Indicators	green LED: ready + teach sequence	●	●	●	●
	yellow LED: switching output	●	●	●	●

1) Teach input not present with 3-pin connector

Sensor adjustment (teach) via teach button



- **The sensor is factory-adjusted for maximum operating range.**
Recommendation: teach only if the desired objects are not reliably detected.
- **Prior to teaching:**
Clear the light path to the reflector!
The device setting is stored in a fail-safe way. A reconfiguration following voltage interruption or switch-off is thus not required.

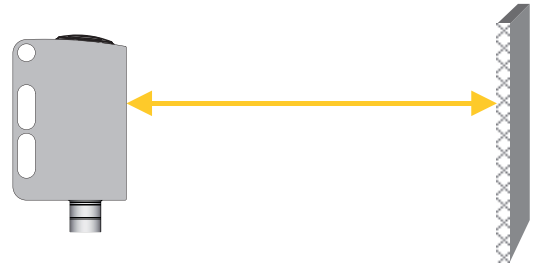

Standard teaching for average sensor sensitivity

- Press teach button until both LEDs flash **simultaneously**.
- Release teach button.
- Ready.



After the standard teaching, the sensor switches when half of the light beam is covered by the object.

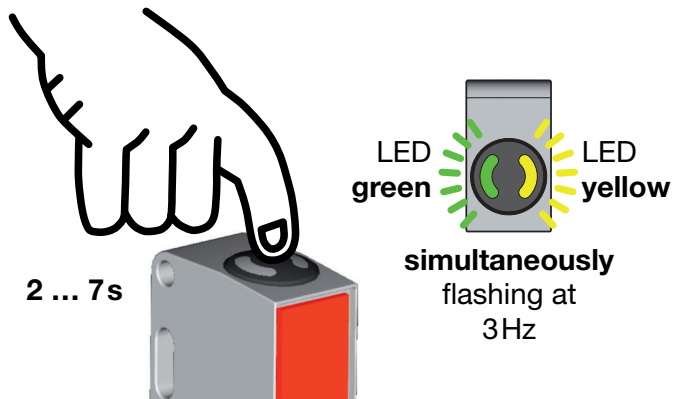

Teaching for increased sensor sensitivity

- Press teach button until both LEDs flash **alternatingly**.
- Release teach button.
- Ready.



After the teaching for increased sensor sensitivity, the sensor switches when about 18% of the light beam are covered by the object.

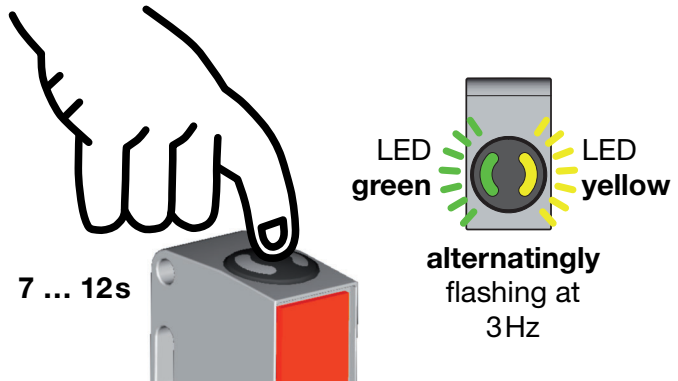

Teaching for maximum operating range (factory setting at delivery)

- Prior to teaching: **Cover the light path to the reflector!**
- Procedure as for standard teaching.

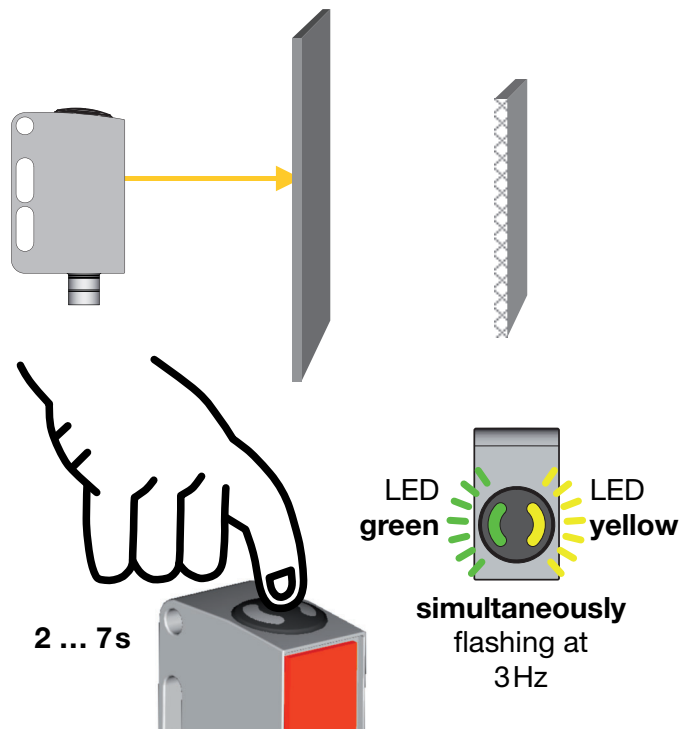

Adjusting the switching behavior of the switching output – light/dark switching

- Press teach button until the green LED flashes. The yellow LED displays the current setting of the switching output:
 ON = output switches on light
 OFF = output switches on dark
- Continue to press the teach button in order to change the switching behavior.
- Release teach button.
- Ready.

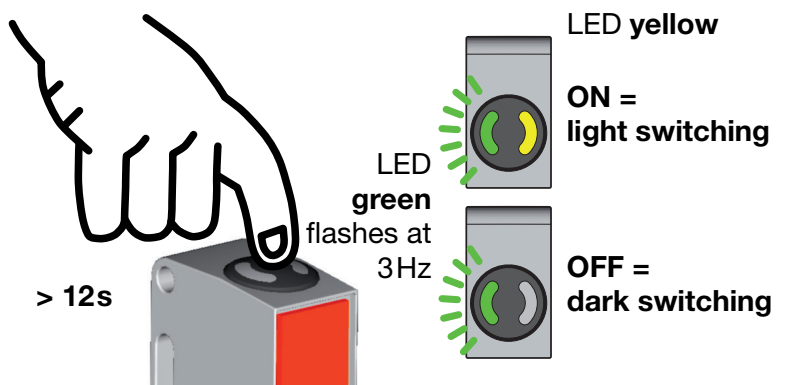

PRK 53 **Retro-reflective photoelectric sensors with polarization filter**

Locking the teach button via the teach input



A **static HIGH signal** (≥ 4 ms) at the teach input locks the teach button on the device if required, such that no manual operation is possible (e.g., protection from erroneous operation or manipulation).

If the teach input is not connected or if there is a static low signal, the button is enabled and can be operated freely.

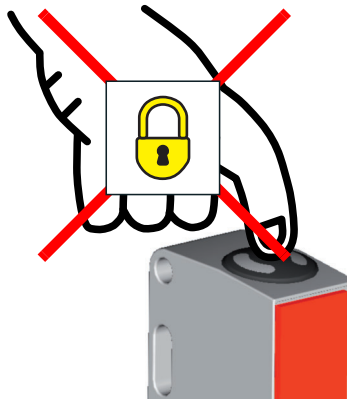

Sensor adjustment (teach) via teach input



The following description applies to PNP switching logic!

$U_{\text{Teach low}} \leq 2V$

$U_{\text{Teach high}} \geq (U_B - 2V)$

Prior to teaching: Clear the light path to the reflector!

The device setting is stored in a fail-safe way. A reconfiguration following voltage interruption or switch-off is thus not required.

Standard teaching for average sensor sensitivity

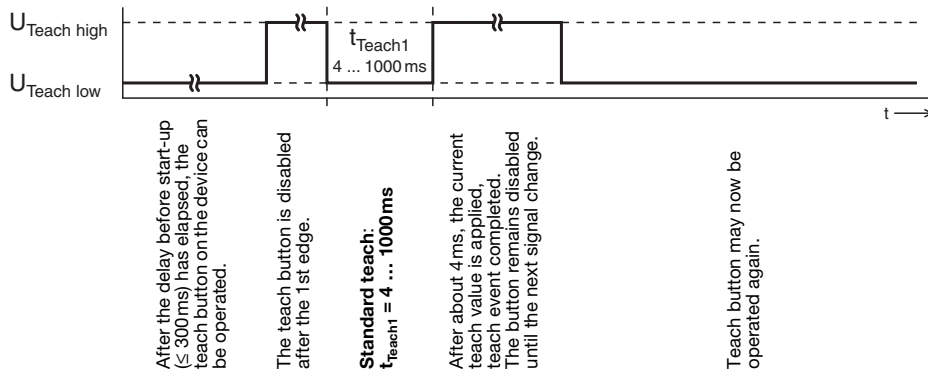

Quick standard teach

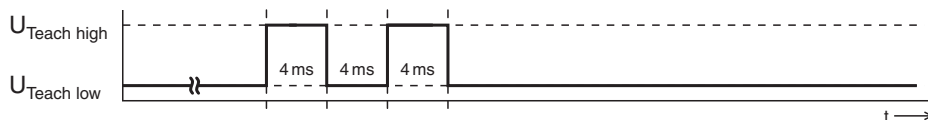

shortest teaching duration for standard teaching: approx. 12ms



After the standard teaching, the sensor switches when half of the light beam is covered by the object.

Teaching for increased sensor sensitivity

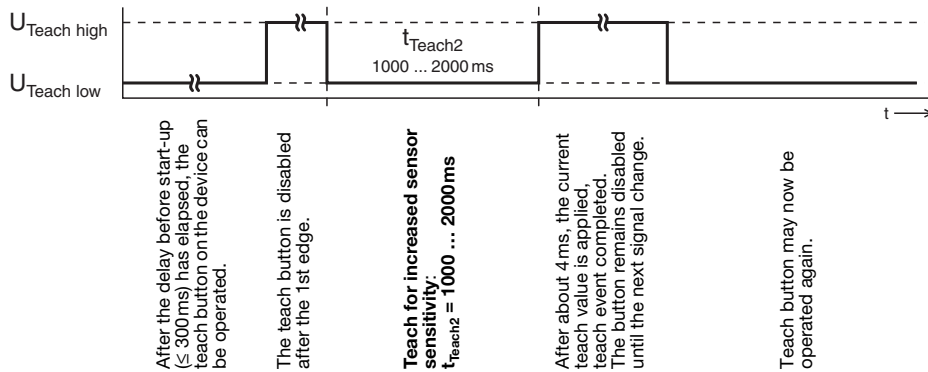

After the teaching for increased sensor sensitivity, the sensor switches when about 18% of the light beam are covered by the object.

Adjusting the switching behavior of the switching output – light/dark switching

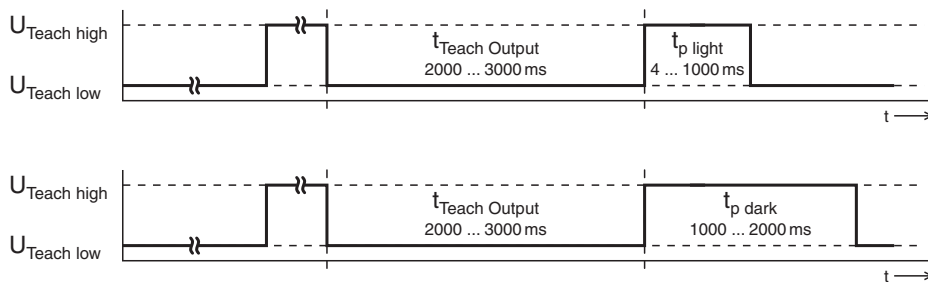

After the delay before start-up (≤ 300ms) has elapsed, the teach button on the device can be operated.

The teach button is disabled after the 1st edge.

Setting the switching behavior of the switching output:
 $t_{\text{Teach Output}} = 2000 \dots 3000 \text{ ms}$

Switching output switches on light:
 $t_{\text{p light}} = 4 \dots 1000 \text{ ms}$

Switching output switches on dark:
 $t_{\text{p dark}} = 1000 \dots 2000 \text{ ms}$

The button remains disabled until the next signal change.