

**PRK 55 Retro-reflective photoelectric sensor with polarization filter for bottles**

en 05-2012/11 50112987-01



0 ... 3.5m  
 1 kHz

10 - 30 V DC  
 stainless steel 316 L

- Polarized retro-reflective photoelectric sensor, autocollimation optics with visible red light
- Particularly suited for highly transparent bottles (PET and glass)
- 316L stainless steel housing in WASH-DOWN-Design
- Enclosed optics design prevents bacterial carry-overs
- ECOLAB and CleanProof+ tested
- Paperless device identification
- Scratch resistant and non-diffusive plastic front cover
- High switching frequency for detection of fast events
- Easy adjustment via lockable teach button or teach input

**Accessories:**

- (available separately)
- Cables with M8 or M12 connector (K-D ...)
  - Cables for food and beverages
  - Reflectors for the foods industry
  - Reflectors for the pharmaceutical industry
  - Reflective tapes
  - Mounting devices

**Dimensioned drawing**

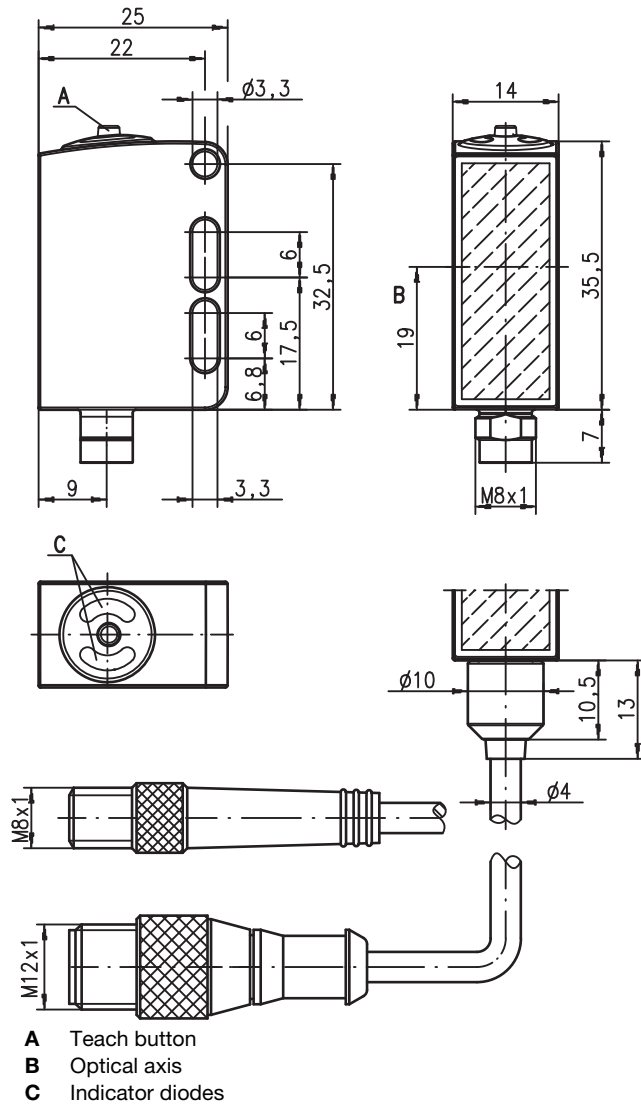

**Electrical connection**

Plug connection, 4-pin (with/without cable)

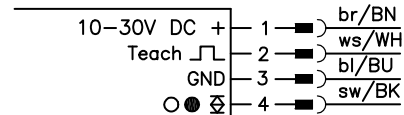

Connector, 3-pin

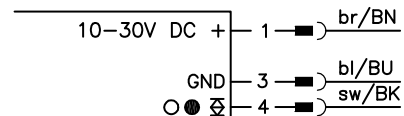

Cable, 4 wires

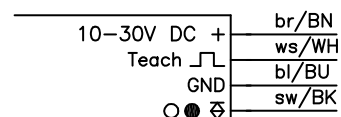

We reserve the right to make changes • DS\_PRK5542\_en\_50112987-01.fm

## Specifications

### Optical data

Typ. op. range limit (TK(S) 100x100) <sup>1)</sup>	0 ... 3.5m
Operating range <sup>2)</sup>	see tables
Light source <sup>3)</sup>	LED (modulated light)
Wavelength	620nm (visible red light, polarized)

### Timing

Switching frequency	1000Hz
Response time	0.5ms
Delay before start-up	≤ 300ms

### Electrical data

Operating voltage $U_B$ <sup>4)</sup>	10 ... 30VDC (incl. residual ripple)
Residual ripple	≤ 15% of $U_B$
Open-circuit current	≤ 18mA
Switching output	.../6.42 1 push-pull switching output pin 4: PNP light switching, NPN dark switching pin 2: teach input
	.../6D.42 1 push-pull switching output pin 4: PNP dark switching, NPN light switching pin 2: teach input
Function characteristics	light/dark reversible
Signal voltage high/low	≥ ( $U_B - 2V$ )/≤ 2V
Output current	max. 100mA
Operating range	setting via teach-in

### Indicators

Green LED	ready
Yellow LED	light path free
Yellow LED, flashing	light path free, no performance reserve <sup>5)</sup>

### Mechanical data

Housing	AISI 316L stainless steel, DIN X2CrNiMo17132, W.No1.4404
Housing design	WASH-DOWN-Design
Housing roughness <sup>6)</sup>	Ra ≤ 2.5
Connector	AISI 316L stainless steel, DIN X2CrNiMo17132, W.No1.4404
Optics cover	coated plastic (PMMA), scratch resistant and non-diffusive
Operation	with M8 connector: 40g
Weight	with 200mm cable and M12 connector: 60g
	with 5000mm cable: 110g
Connection type	M8 connector, 4-pin, 0.2m cable with M12 connector, 4-pin, 5m cable, 4 x 0.20mm <sup>2</sup>

### Environmental data

Ambient temp. (operation/storage) <sup>7)</sup>	-30°C ... +70°C/-30°C ... +70°C
Protective circuit <sup>8)</sup>	2, 3
VDE safety class <sup>9)</sup>	III
Protection class	IP 67, IP 69K <sup>10)</sup>
Environmentally tested acc. to	ECOLAB, CleanProof+
LED class	1 (in accordance with EN 60825-1)
Standards applied	IEC 60947-5-2
Certifications	UL 508 <sup>4)</sup>
Chemical resistance	tested in accordance with ECOLAB and CleanProof+ (see Remarks)

### Options

#### Teach-in input/activation input

Transmitter active/not active	≥ 8V/≤ 2V
Activation/disable delay	≤ 1ms
Input resistance	30kΩ

- 1) Typ. operating range limit: max. attainable range without performance reserve
- 2) Operating range: recommended range with performance reserve
- 3) Average life expectancy 100,000h at an ambient temperature of 25°C
- 4) For UL applications: for use in class 2 circuits according to NEC only
- 5) Display "no performance reserve" as yellow flashing LED is only available in standard teach setting
- 6) Typical value for the stainless steel housing
- 7) Operating temperatures of +70°C permissible only briefly (≤ 15min)
- 8) 2=polarity reversal protection, 3=short circuit protection for all transistor outputs
- 9) Rating voltage 50V
- 10)Only in combination with M12 connector

## Remarks

- The light spot may not exceed the reflector.
- Preferably use MTK(S) or tape 6.
- For foil 6, the sensor's side edge must be aligned parallel to the side edge of the reflective tape.

## Approved purpose

This product may only be used by qualified personnel and must only be used for the approved purpose. This sensor is not a safety sensor and is not to be used for the protection of persons.

## Tables

Reflectors in food quality			Operating range
1	TK(S)	100x100	0 ... 3.0m
2	TK	40x60	0 ... 2.0m
3	MTKS	50x50.1	0 ... 1.3m
4	Tape 6	50x50	0 ... 1.2m
5	TK	20x40	0 ... 1.0m

1	0		3	3.6
2	0	2.0	2.4	
3	0	1.3	1.6	
4	0	1.2	1.4	
5	0	1.0	1.2	

Pharmaceutical reflectors			Operating range
1	TK(S)	40x60.P	0 ... 1.2m
2	TK	BR53	0 ... 1.0m
3	TK(S)	20x40.P	0 ... 0.7m
4	TK(S)	20.P	0 ... 0.5m
5	MTK(S)	14x23.P	0 ... 0.25m
6	TK	10.P	0 ... 0.2m

  

1	0		1.2	1.4
2	0		1.0	1.2
3	0	0.7	0.8	
4	0	0.5	0.6	
5	0	0.25	0.3	
6	0	0.2	0.25	

□ Operating range [m]  
 □ Typ. operating range limit [m]

TK ... = adhesive  
 TKS ... = screw type

## Diagrams

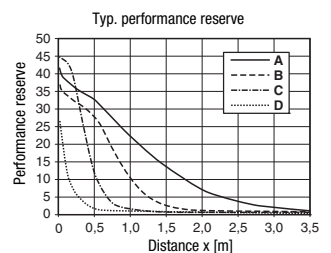
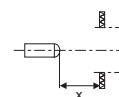
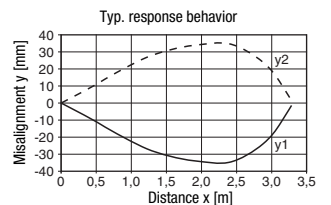

- A TK 100x100
- B TKS 40x60
- C TKS 20x40
- D Tape 4: 50x50

## Remarks

A list of tested chemicals can be found in the first part of the product description.

**PRK 55 Retro-reflective photoelectric sensor with polarization filter for bottles**

**Order guide**

Selection table		Order code →				
Equipment ↓		PRK 55/6.42-S8 Part no. 50112991	PRK 55/6.42, 200-S12 Part no. 50112477	PRK 55/6D.42-S8 Part no. 50112992	PRK 55/6D.42, 200-S12 Part no. 50112478	PRK 55/6.42, 5000 Part no. 50114071
Switching output	1 x push-pull switching output	●	●	●	●	●
Switching function	light switching	●	●			●
	dark switching			●	●	
	light/dark switching configurable	●	●	●	●	●
Connection	M8 connector, metal, 4-pin	●		●		
	M8 connector, metal, 3-pin					
	cable 200mm with M12 connector, 4-pin		●		●	●
	cable 5000mm, 4-wire					●
Configuration	teach-in via button (lockable) and teach input <sup>1)</sup>	●	●	●	●	●
Indicators	Green LED: ready + teach sequence	●	●	●	●	●
	yellow LED: switching output	●	●	●	●	●
Detection	foils < 20µm thick					
	foils > 20µm thick	●	●	●	●	●
	bottles (PET and glass)	●	●	●	●	●

1) Teach input not present with 3-pin connector

**Sensor adjustment (teach) via teach button**



- **The sensor is factory-adjusted for maximum operating range.**  
Recommendation: teach only if the desired objects are not reliably detected.
- **Prior to teaching: Clear the light path to the reflector!**  
The device setting is stored in a fail-safe way. A reconfiguration following voltage interruption or switch-off is thus not required.

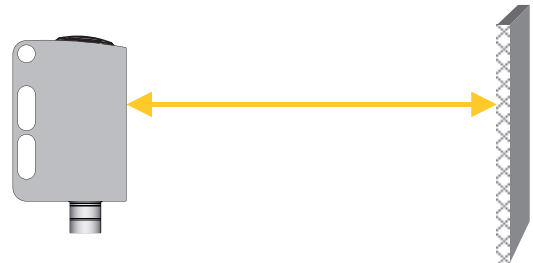

***Teach for 11% sensor sensitivity (highly transparent bottles and foils with thickness > 20µm)***

- Press teach button until both LEDs flash **simultaneously**.
- Release teach button.
- Ready.



After the teaching, the sensor switches when about 11 % of the light beam are covered by the object.

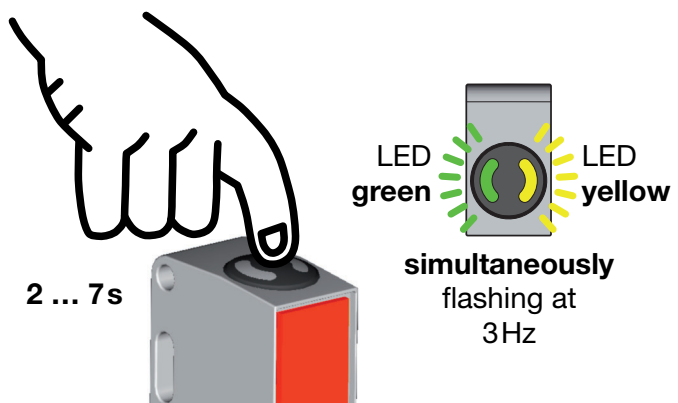

**Teach for 18% sensor sensitivity (standard bottles)**

- Press teach button until both LEDs flash **alternatingly**.
- Release teach button.
- Ready.



After the teaching, the sensor switches when about 18% of the light beam are covered by the object.

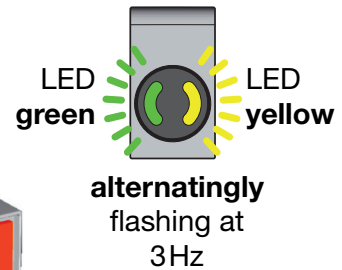
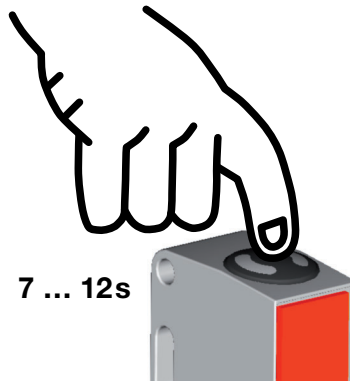

**Teaching for maximum operating range (factory setting at delivery)**

- Prior to teaching: **Cover the light path to the reflector!**
- Press teach button until both LEDs flash **simultaneously**.
- Release teach button.
- Ready.

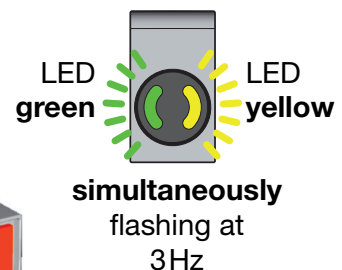
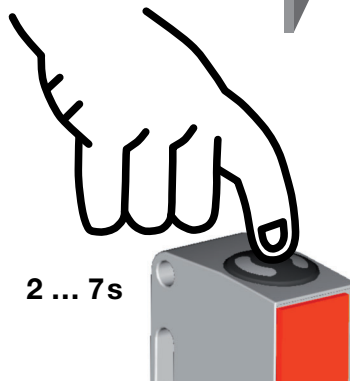
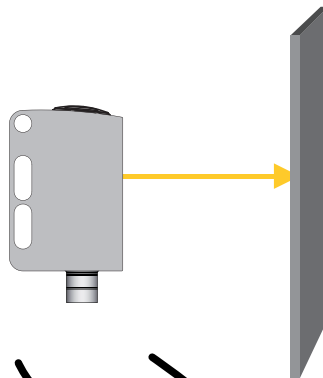

**Adjusting the switching behavior of the switching output – light/dark switching**

- Press teach button until the green LED flashes. The yellow LED displays the current setting of the switching output:  
 ON = output switches on light  
 OFF = output switches on dark
- Continue to press the teach button in order to change the switching behavior.
- Release teach button.
- Ready.

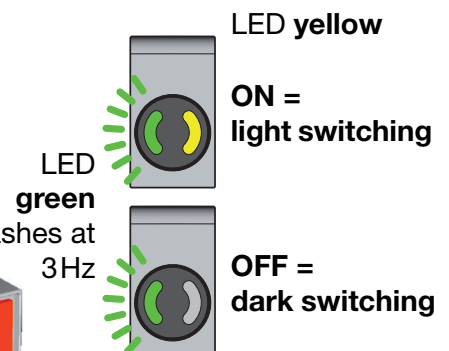
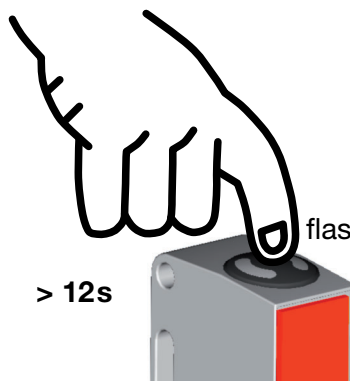

**PRK 55 Retro-reflective photoelectric sensor with polarization filter for bottles**

**Locking the teach button via the teach input**



A **static high signal** ( $\geq 4$  ms) at the teach input locks the teach button on the device if required, such that no manual operation is possible (e.g., protection from erroneous operation or manipulation).

If the teach input is not connected or if there is a static low signal, the button is unlocked and can be operated freely.

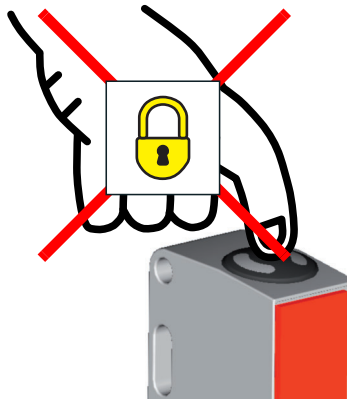

**Sensor adjustment (teach) via teach input**



The following description applies to PNP switching logic!

$U_{\text{Teach low}} \leq 2V$

$U_{\text{Teach high}} \geq (U_B - 2V)$

**Prior to teaching: Clear the light path to the reflector!**

The device setting is stored in a fail-safe way. A reconfiguration following voltage interruption or switch-off is thus not required.

**Teach for 11% sensor sensitivity**  
**(highly transparent bottles and foils with thickness > 20µm)**

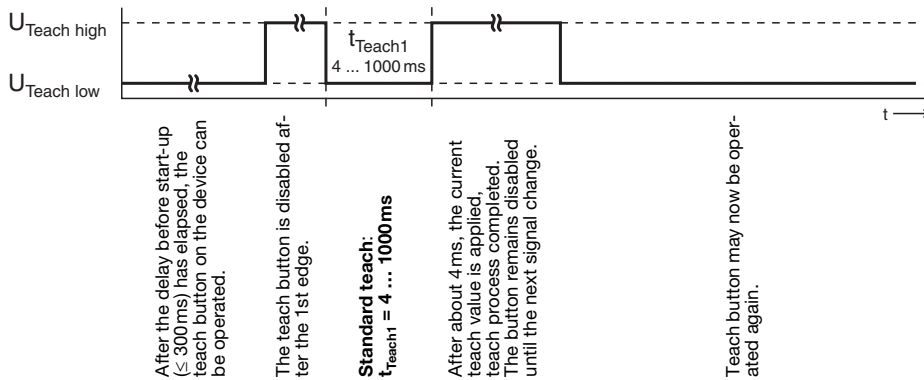

**Quick teach for 11% sensor sensitivity**  
**(highly transparent bottles and foils with thickness > 20µm)**

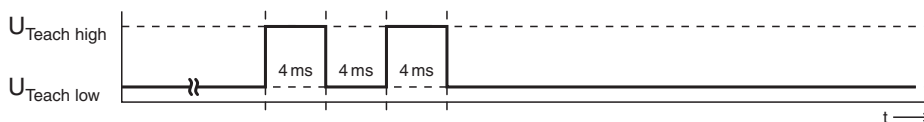

**Shortest teaching duration for this teaching: approx. 12ms**



After the teaching, the sensor switches when about 11% of the light beam are covered by the object.

**Teach for 18% sensor sensitivity (standard bottles)**

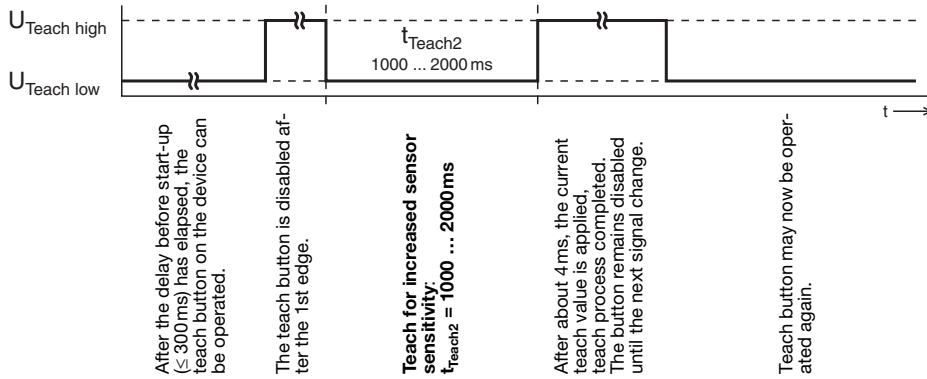

After the delay before start-up ( $\leq 300\text{ms}$ ) has elapsed, the teach button on the device can be operated.

The teach button is disabled after the 1st edge.

**Teach for increased sensor sensitivity:**  
 $t_{\text{teach}2} = 1000 \dots 2000\text{ms}$

After about 4 ms, the current teach value is applied, teach process completed. The button remains disabled until the next signal change.

Teach button may now be operated again.



After the teaching, the sensor switches when about 18% of the light beam are covered by the object.

**Adjusting the switching behavior of the switching output – light/dark switching**

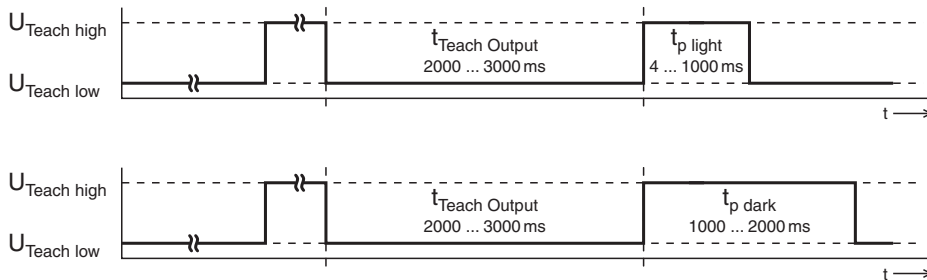

After the delay before start-up ( $\leq 300\text{ms}$ ) has elapsed, the teach button on the device can be operated.

The teach button is disabled after the 1st edge.

**Setting the switching behavior of the switching output:**  
 $t_{\text{teach Output}} = 2000 \dots 3000\text{ms}$

**Switching output switches on light:**  
 $t_{\text{p light}} = 4 \dots 1000\text{ms}$

**Switching output switches on dark:**  
 $t_{\text{p dark}} = 1000 \dots 2000\text{ms}$

The button remains disabled until the next signal change.