

RKR 53

Retro-reflective photoelectric sensor for foils

en 04-2012/06 50108252-01



Dimensioned drawing

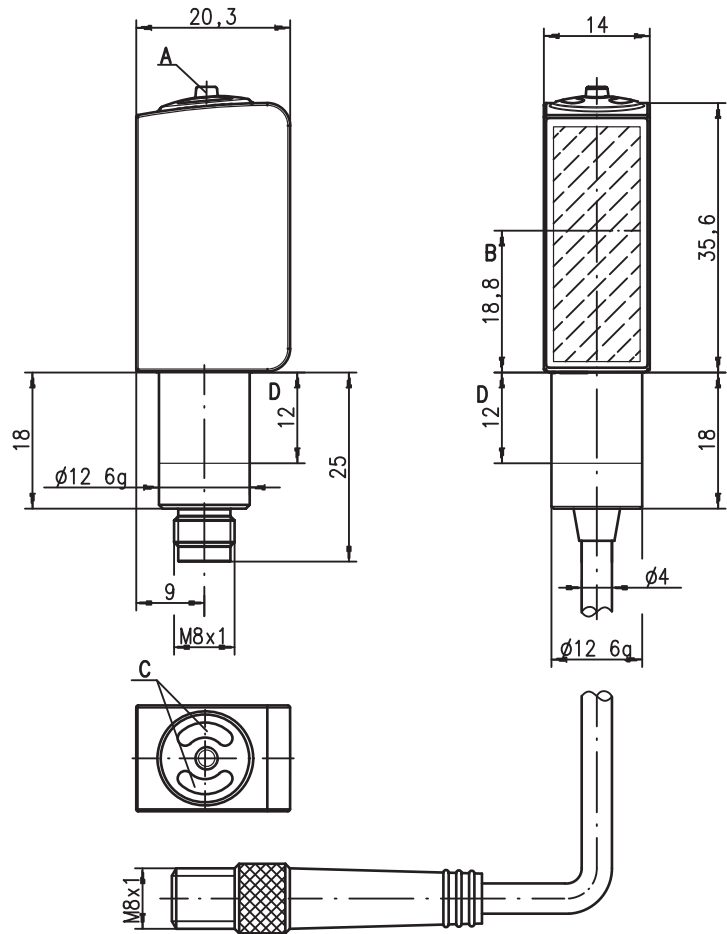

- A Teach button
- B Optical axis
- C Indicator diodes
- D Permissible clamping range

0 ... 1.8m
1 kHz
0 ... 1.8m
10 - 30 V DC
stainless steel 316 L

- Retro-reflective photoelectric sensor, auto-collimation optics with visible red light
- Particularly suited for thin, highly transparent foils with thickness < 20µm
- 316L stainless steel housing in HYGIENE-Design
- Enclosed optics design prevents bacterial carry-overs
- ECOLAB and CleanProof+ tested
- Paperless device identification
- Scratch resistant and non-diffusive plastic front cover
- High switching frequency for detection of fast events
- May also be used with glass reflectors (TG)
- Easy adjustment via lockable teach button or teach input

Electrical connection

Plug connection, 4-pin (with/without cable)

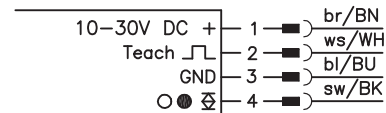

Plug connector, 3-pin

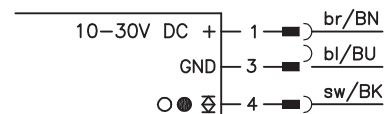

Accessories:

(available separately)

- Cables with M8 or M12 connector (K-D ...)
- Cables for food and beverages
- Reflectors for the foods industry
- Reflectors for the pharmaceutical industry
- Reflective tapes
- Mounting devices

We reserve the right to make changes • DS_RKF53642_en_50108252-01.fm

Specifications

Optical data

Typ. op. range limit (TK(S) 100x100) ¹⁾	0 ... 1.8m
Operating range ²⁾	see tables
Light source ³⁾	LED (modulated light)
Wavelength	620nm (visible red light)

Timing

Switching frequency	1000Hz
Response time	0.5ms
Delay before start-up	≤ 300ms

Electrical data

Operating voltage U_B ⁴⁾	10 ... 30VDC (incl. residual ripple)
Residual ripple	≤ 15% of U_B
Open-circuit current	≤ 15mA
Switching output	.../6.42 1 push-pull switching output pin 4: PNP light switching, NPN dark switching pin 2: teach input light/dark reversible
Function characteristics	light/dark reversible
Signal voltage high/low	≥ ($U_B - 2V$) ≤ 2V
Output current	max. 100mA
Operating range	setting via teach-in

Indicators

Green LED	ready
Yellow LED	light path free

Mechanical data

Housing	AISI 316L stainless steel, DIN X2CrNiMo17132, W.No1.4404
Housing design	HYGIENE-Design
Housing roughness ⁵⁾	$R_a \leq 2.5$
Connector	AISI 316L stainless steel, DIN X2CrNiMo17132, W.No1.4404
Optics cover	coated plastic (PMMA), scratch resistant and non-diffusive
Operation	plastic (TPV-PE), non-diffusive
Weight	with M8 connector: 50g with 200mm cable and M8 connector: 60g
Connection type	M8 connector, 4-pin or 3-pin 0.2m cable with M8 connector, 4-pin via fit (see "Remarks")
Fastening	
Max. tightening torque	3 Nm (permissible range, see dimensioned drawing)

Environmental data

Ambient temp. (operation/storage) ⁶⁾	-30°C ... +70°C / -30°C ... +70°C
Protective circuit ⁷⁾	2, 3
VDE safety class ⁸⁾	III
Protection class	IP 67, IP 69K ⁹⁾
Environmentally tested acc. to LED class	ECOLAB, CleanProof+
Standards applied	1 (in accordance with EN 60825-1)
Certifications	IEC 60947-5-2
Chemical resistance	UL 508 ⁴⁾ tested in accordance with ECOLAB and CleanProof+ (see Remarks)

Options

Teach-in input/activation input

Transmitter active/not active	≥ 8V/≤ 2V
Activation/disable delay	≤ 1ms
Input resistance	30kΩ

- 1) Typ. operating range limit: max. attainable range without performance reserve
- 2) Operating range: recommended range with performance reserve
- 3) Average life expectancy 100,000h at an ambient temperature of 25°C
- 4) For UL applications: for use in class 2 circuits according to NEC only
- 5) Typical value for the stainless steel housing
- 6) Operating temperatures of +70°C permissible only briefly (≤ 15min)
- 7) 2=polarity reversal protection, 3=short circuit protection for all transistor outputs
- 8) Rating voltage 50V
- 9) Only with internal tube mounting of the M8 connector

Approved purpose

This product may only be used by qualified personnel and must only be used for the approved purpose. This sensor is not a safety sensor and is not to be used for the protection of persons.

Tables

Reflectors in food quality		Operating range
1	TK(S) 100x100	0 ... 1.5m
2	TK 40x60	0 ... 1.0m
3	MTKS 50x50.1	0 ... 1.0m
4	Tape 6 50x50	0 ... 0.6m
5	TK 20x40	0 ... 0.5m

1	0	1.5	1.8
2	0	1	1.2
3	0	1	1.2
4	0	0.6	0.7
5	0	0.5	0.6

Pharmaceutical reflectors		Operating range
1	TK(S) 40x60.P	0 ... 0.6m
2	TK BR53	0 ... 0.4m
3	TK(S) 20x40.P	0 ... 0.35m
4	TK(S) 20.P	0 ... 0.25m
5	MTK(S) 14x23.P	0 ... 0.15m
6	TK 10.P	0 ... 0.1m

1	0	0.6	0.7
2	0	0.4	0.5
3	0	0.35	0.42
4	0	0.25	0.3
5	0	0.15	0.18
6	0	0.1	0.12

□ Operating range [m]
 ▒ Typ. operating range limit [m]

TK ... = adhesive
 TKS ... = screw type
 MTKS ... = micro triple, screw type

Diagrams

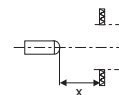
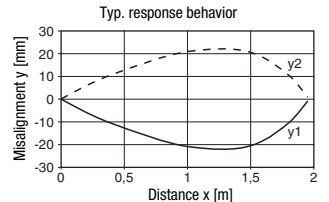

Remarks

A list of tested chemicals can be found in the first part of the product description.

Only secure in designated area using set screw. Max. tightening torque 3Nm.

Order guide

Selection table		Order code →		
Equipment ↓		RKR 53/6.42-S8 Part no. 50107607	RKR 53/6.42, 200-S8 Part no. 50105790	RKR 53/6.42-S8.3 Part no. 50107608
Switching output	1 x push-pull switching output	●	●	●
Switching function	light/dark switching configurable	●	●	●
Connection	M8 connector, metal, 4-pin	●		
	cable 200mm with M8 connector, 4-pin		●	
	M8 connector, metal, 3-pin			●
Configuration	teach-in via button (lockable) and teach input ¹⁾	●	●	●
Indicators	green LED: ready	●	●	●
	yellow LED: switching output	●	●	●
Detection	foils < 20µm thick	●	●	●
	foils > 20µm thick	●	●	●
	bottles (PET and glass)	●	●	●

1) Teach input not present with 3-pin connector

General information

- The sensor is factory-adjusted for the detection of colored glass.
Recommendation: teach only if the desired objects are not reliably detected.
- The light spot may not exceed the reflector.
- Preferably use MTK(S) or tape 6.
- For foil 6, the sensor's side edge must be aligned parallel to the side edge of the reflective tape.
- For reflecting objects, the sensor has to be mounted approx. 5° angular towards the object.

Sensor adjustment (teach) via teach button

- **Prior to teaching:**
Clear the light path to the reflector!
The device setting is stored in a fail-safe way. A reconfiguration following voltage interruption or switch-off is thus not required.

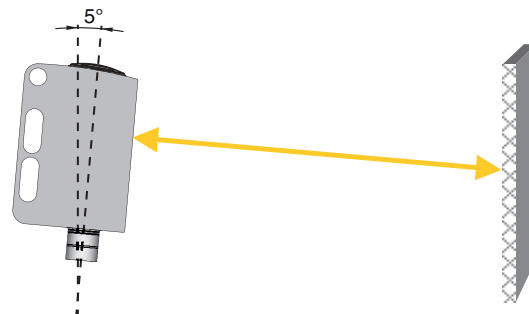

Standard teaching for average sensor sensitivity (standard bottles)

- Press teach button until both LEDs flash **simultaneously**.
- Release teach button.
- Ready.



If the receive signal from the reflector is too weak, the sensor indicates the error status by means of fast and simultaneous flashing of the green and yellow LEDs. Please check the alignment, operating range, and soiling and carry out another teaching.

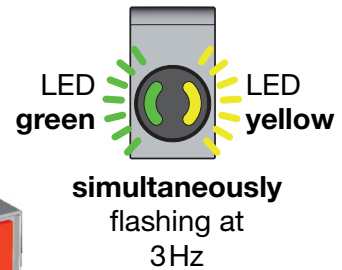
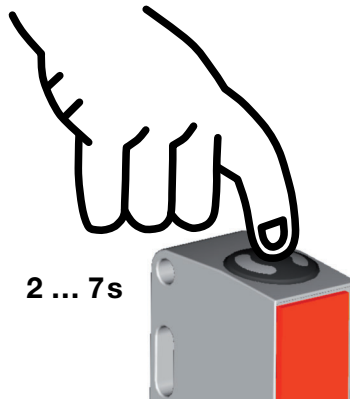

Teach for increased sensor sensitivity (highly transparent bottles and foils with thickness < 20µm)

- Press teach button until both LEDs flash **alternatingly**.
- Release teach button.
- Ready.



If the receive signal from the reflector is too weak, the sensor indicates the error status by means of fast and simultaneous flashing of the green and yellow LEDs. Please check the alignment, operating range, and soiling and carry out another teaching.

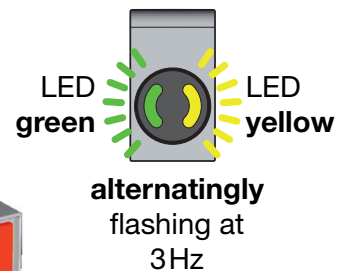
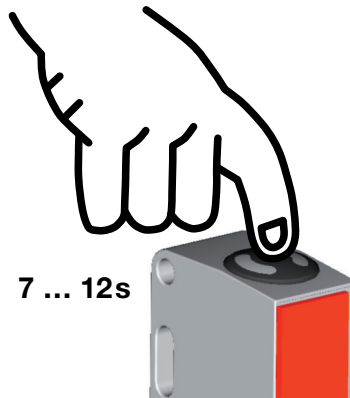

Adjusting the switching behavior of the switching output – light/dark switching

- Press teach button until the green LED flashes. The yellow LED displays the current setting of the switching output:
ON = output switches on light
OFF = output switches on dark
- Continue to press the teach button in order to change the switching behavior.
- Release teach button.
- Ready.

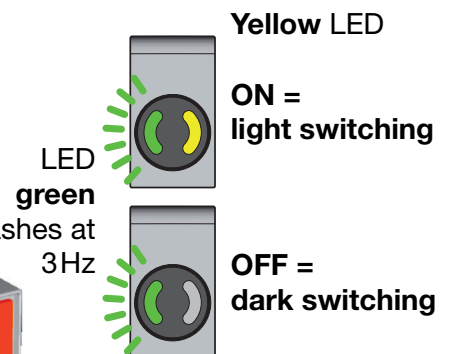
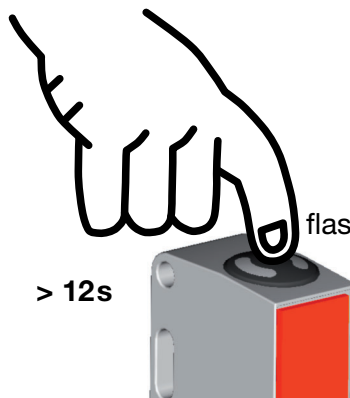

Locking the teach button via the teach input



A **static high signal** (≥ 4 ms) at the teach input locks the teach button on the device if required, such that no manual operation is possible (e.g., protection from erroneous operation or manipulation).

If the teach input is not connected or if there is a static low signal, the button is unlocked and can be operated freely.

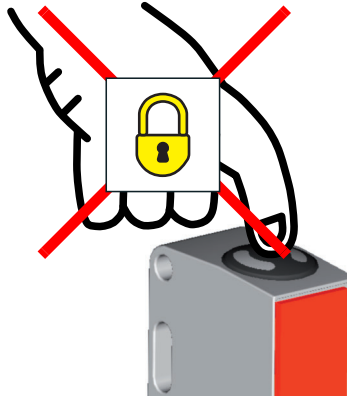

Sensor adjustment (teach) via teach input



The following description applies to PNP switching logic!

$U_{Teach\ low} \leq 2V$

$U_{Teach\ high} \geq (U_B - 2V)$

Prior to teaching: Clear the light path to the reflector!

The device setting is stored in a fail-safe way. A reconfiguration following voltage interruption or switch-off is thus not required.

Standard teaching for average sensor sensitivity (standard bottles)

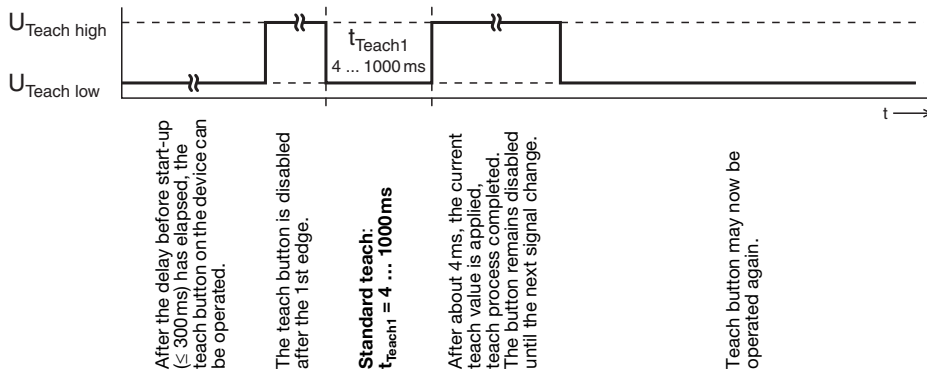

Quick standard teach (standard bottles)

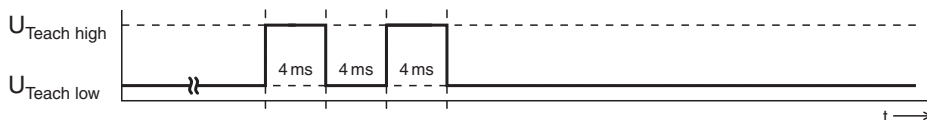

shortest teaching duration for standard teaching: approx. 12ms



If the receive signal from the reflector is too weak, the sensor indicates the error status by means of fast and simultaneous flashing of the green and yellow LEDs. Please check the alignment, operating range, and soiling and carry out another teaching.

Teach for increased sensor sensitivity (highly transparent bottles and foils with thickness < 20µm)

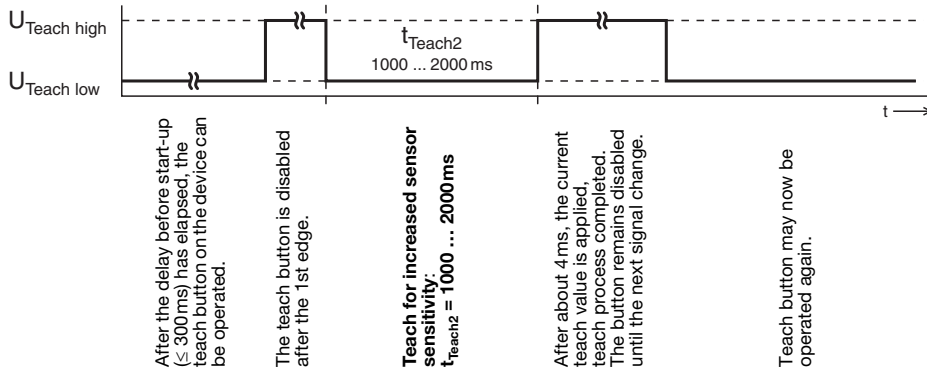

If the receive signal from the reflector is too weak, the sensor indicates the error status by means of fast and simultaneous flashing of the green and yellow LEDs. Please check the alignment, operating range, and soiling and carry out another teaching.

Adjusting the switching behavior of the switching output – light/dark switching

