



RT 96

Energetic diffuse reflection light scanners



Dimensioned drawing

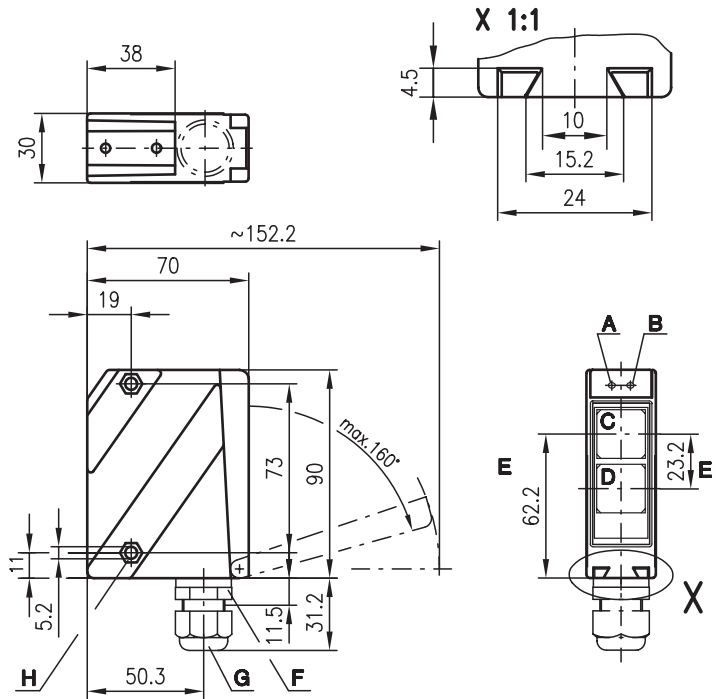

30 ... 700 mm  
20 ... 1200 mm

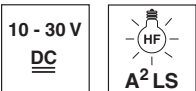

- Robust metal housing with glass cover or plastic housing, protection class IP 67/ IP 69K for industrial application
- Sensitivity adjustment and delay before start-up for optimal adaptation to the application
- Minimal short range
- Connection via M12 connector or terminal compartment
- Multiple options with warning output, activation input, switching delays and optics heating for use at low temperatures

- A Indicator diode green
- B Indicator diode yellow
- C Receiver
- D Transmitter
- E Optical axis
- F Device plug M12
- G Screwed cable gland M16x1.5 for Ø 5 ... 10mm
- H Countersinking for SK nut M5, 4.2 deep
- I Connection terminals
- K Cable entry
- L Sensitivity adjustment

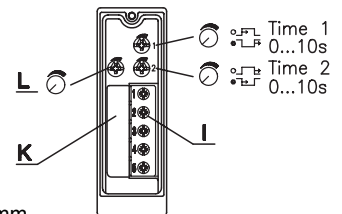

Electrical connection

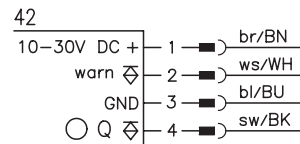

Accessories:

(available separately)

- Mounting systems (BT 96, BT 96.1, UMS 96, BT 450.1-96)
- M12 connectors (KD ...)
- Ready-made cables (K-D ...)

We reserve the right to make changes • 96\_c01e.fm



### Specifications

#### Optical data

Typ. scanning range limit (white 90%) <sup>1)</sup>  
 Scanning range <sup>2)</sup>  
 Adjustment range  
 Light source  
 Wavelength

#### Infrared light

20 ... 1200mm  
 20 ... 800mm  
 0 ... 100%  
 LED (modulated light)  
 880nm

#### Red light

30 ... 700mm  
 30 ... 500mm  
 0 ... 100%  
 LED (modulated light)  
 660nm

#### Timing

Switching frequency 1000Hz  
 Response time 0.5ms  
 Delay before start-up ≤ 200ms

#### Electrical data

Operating voltage  $U_B$  10 ... 30VDC (incl. residual ripple)  
 Residual ripple ≤ 15% of  $U_B$   
 Bias current ≤ 40mA, ≤ 75mA with optics heating  
 Switching output PNP transistor  
 Function characteristics light switching  
 Signal voltage high/low ≥ ( $U_B - 2V$ ) / ≤ 2V  
 Output current max. 100mA  
 Sensitivity adjustable

#### Indicators

LED green ready  
 LED yellow reflection  
 LED yellow flashing reflection, no performance reserve

#### Mechanical data

Housing diecast zinc  
 Optics cover glass  
 Weight 380g  
 Connection type terminals or M12 connector

#### Environmental data

Ambient temp. (operation/storage) -20°C ... +60°C / -40°C ... +70°C  
 Protective circuit <sup>3)</sup> 1, 2, 3, 4  
 VDE safety class <sup>4)</sup> II, all-insulated  
 Protection class IP 67, IP 69K <sup>5)</sup>  
 LED class 1 (acc. to EN 60825-1)  
 Standards applied IEC 60947-5-2

#### Options

**Warning output autoControl warn** PNP transistor, 100mA, counting principle  
**Optics heating** for temperature changes, prevents fogging  
**Low temperature** to -35°C  
**Switching delay** (slow oper./release) 0 ... 10s (separately adjustable)

- 1) Typ. scanning range limit: max. attainable range without performance reserve
- 2) Scanning range: recommended range with performance reserve
- 3) 1=transient protection, 2=polarity reversal protection, 3=short circuit protection for all outputs, 4=interference blanking
- 4) Rating voltage 250VAC
- 5) IP 69K test acc. to DIN 40050 part 9 simulated, high pressure cleaning conditions without the use of additives, acids and bases are not part of the test

### Order guide

Selection table		Order code →					
Equipment ↓		RT 96M/P-1374-500-42 Part No. 500 41596	RT 96M/P-1474-800-42 Part No. 500 41597				
Housing	metal	●	●				
	plastic						
Light source	red light (500mm)	●					
	infrared light (800mm)		●				
Connection	terminals						
	M12 connector	●	●				
Features	optics heating/low temp.						
	switching delay		●				
	warning output	●	●				
	short range (20mm)	●	●				
	NPN switching output						

### Tables

#### Red light

1	30	500	700
2	65	320	430
3	90	200	370

#### Infrared light

1	20	800	1200
2	60	420	950
3	80	290	570

1	white 90%
2	grey 18%
3	black 6%

Scanning range [mm]  
 Typ. scanning range limit [mm]

### Diagrams

#### Red light

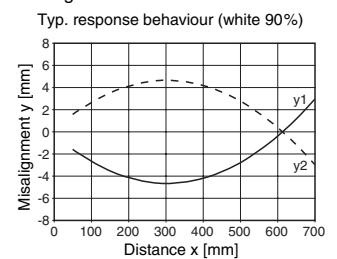

#### Infrared light

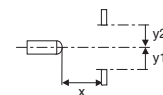
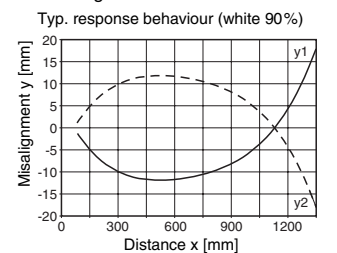

### Remarks

- The upper and lower scanning range limit varies depending on the reflection properties of the material surface.
- **Short range** objects are detected down to a minimum distance of 20mm.