

the sensor people

AMS 384*i*
Optical Laser Measurement System
Interbus

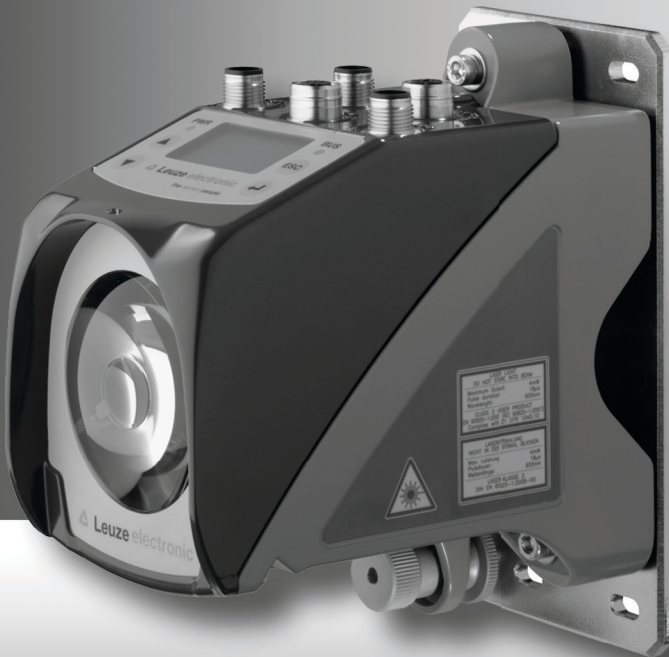

Sales and Service

Germany

Sales Region North

Phone 07021/573-306
 Fax 07021/9850950

Postal code areas

20000-38999
 40000-65999
 97000-97999

Sales Region South

Phone 07021/573-307
 Fax 07021/9850911

Postal code areas

66000-96999

Sales Region East

Phone 035027/629-106
 Fax 035027/629-107

Postal code areas

01000-19999
 39000-39999
 98000-99999

Worldwide

AR (Argentina)

Condelectric S.A.
 Tel. Int. + 54 1148 361053
 Fax Int. + 54 1148 361053

AT (Austria)

Schmachtl GmbH
 Tel. Int. + 43 732 7646-0
 Fax Int. + 43 732 7646-785

AU + NZ (Australia + New Zealand)

Balluff-Leuze Pty. Ltd.
 Tel. Int. + 61 3 9720 4100
 Fax Int. + 61 3 9738 2677

BE (Belgium)

Leuze electronic nv/sa
 Tel. Int. + 32 2253 16-00
 Fax Int. + 32 2253 15-36

BG (Bulgaria)

ATICS
 Tel. Int. + 359 2 847 6244
 Fax Int. + 359 2 847 6244

BR (Brasil)

Leuze electronic Ltda.
 Tel. Int. + 55 11 5180-6130
 Fax Int. + 55 11 5180-6141

CH (Switzerland)

Leuze electronic AG
 Tel. Int. + 41 41 784 5656
 Fax Int. + 41 41 784 5657

CL (Chile)

Imp. Tec. Vignola S.A.I.C.
 Tel. Int. + 56 3235 11-11
 Fax Int. + 56 3235 11-28

CN (China)

Leuze electronic Trading
 (Shenzhen) Co. Ltd.
 Tel. Int. + 86 755 862 64909
 Fax Int. + 86 755 862 64901

CO (Colombia)

Componentes Electronicas Ltda.
 Tel. Int. + 57 4 3511049
 Fax Int. + 57 4 3511019

CZ (Czech Republic)

Schmachtl CZ s.r.o.
 Tel. Int. + 420 244 0015-00
 Fax Int. + 420 244 9107-00

DK (Denmark)

Leuze electronic Scandinavia ApS
 Tel. Int. + 45 48 173200

ES (Spain)

Leuze electronic S.A.
 Tel. Int. + 34 93 4097900
 Fax Int. + 34 93 49035820

FI (Finland)

SKS-automaatio Oy
 Tel. Int. + 358 20 764-61
 Fax Int. + 358 20 764-6820

FR (France)

Leuze electronic Sarl.
 Tel. Int. + 33 160 0512-20
 Fax Int. + 33 160 0503-65

GB (United Kingdom)

Leuze electronic Ltd.
 Tel. Int. + 44 14 8040 85-00
 Fax Int. + 44 14 8040 38-08

GR (Greece)

UTECO A.B.E.E.
 Tel. Int. + 30 211 1206 900
 Fax Int. + 30 211 1206 999

HK (Hong Kong)

Sensortech Company
 Tel. Int. + 852 26510188
 Fax Int. + 852 26510388

HR (Croatia)

Tipteh Zagreb d.o.o.
 Tel. Int. + 385 1 381 6574
 Fax Int. + 385 1 381 6577

HU (Hungary)

Kvaik Automatika Kft.
 Tel. Int. + 36 1 272 2242
 Fax Int. + 36 1 272 2244

ID (Indonesia)

P.T. Yabestindo Mitra Utama
 Tel. Int. + 62 21 92861859
 Fax Int. + 62 21 6451044

IL (Israel)

Galoz electronics Ltd.
 Tel. Int. + 972 3 9023456
 Fax Int. + 972 3 9021990

IN (India)

M + V Marketing Sales Pvt Ltd.
 Tel. Int. + 91 124 4121623
 Fax Int. + 91 124 434233

IT (Italy)

Leuze electronic S.r.l.
 Tel. Int. + 39 02 26 1106-43
 Fax Int. + 39 02 26 1106-40

JP (Japan)

C. Illies & Co., Ltd.
 Tel. Int. + 81 3 3443 4143
 Fax Int. + 81 3 3443 4118

KE (Kenia)

Profa-Tech Ltd.
 Tel. Int. + 254 20 82905/6
 Fax Int. + 254 20 828129

KR (South Korea)

Leuze electronic Co., Ltd.
 Tel. Int. + 82 31 3828228
 Fax Int. + 82 31 3828522

MK (Macedonia)

Tipteh d.o.o. Skopje
 Tel. Int. + 389 70 399 474
 Fax Int. + 389 23 174 197

MX (Mexico)

Movitren S.A.
 Tel. Int. + 52 81 8371 8616
 Fax Int. + 52 81 8371 8588

MY (Malaysia)

Ingermark (M) SDN BHD
 Tel. Int. + 60 360 3427-88
 Fax Int. + 60 360 3421-88

NG (Nigeria)

SABROW HI-TECH E. & A. LTD.
 Tel. Int. + 234 80333 86366
 Fax Int. + 234 80333 8446318

NL (Netherlands)

Leuze electronic BV
 Tel. Int. + 31 418 65 35-44
 Fax Int. + 31 418 65 38-08

NO (Norway)

Eiteco A/S
 Tel. Int. + 47 35 56 20-70
 Fax Int. + 47 35 56 20-99

PL (Poland)

Balluff Sp. z o.o.
 Tel. Int. + 48 71 338 49 29
 Fax Int. + 48 71 338 49 30

PT (Portugal)

LA2P, Lda.
 Tel. Int. + 351 21 4 447070
 Fax Int. + 351 21 4 447075

RO (Romania)

O BOYLE S.r.l.
 Tel. Int. + 40 2 56201346
 Fax Int. + 40 2 56221036

RS (Republic of Serbia)

Tipteh d.o.o. Beograd
 Tel. Int. + 381 11 3131 057
 Fax Int. + 381 11 3018 326

RU (Russian Federation)

ALL IMPEX 2001
 Tel. Int. + 7 495 9213012
 Fax Int. + 7 495 6462092

SE (Sweden)

Leuze electronic Scandinavia ApS
 Tel. Int. + 45 48 173200

SG + PH (Singapore + Philippines)

Balluff Asia Pte Ltd
 Tel. Int. + 65 6252 43-84
 Fax Int. + 65 6252 90-60

SI (Slovenia)

Tipteh d.o.o.
 Tel. Int. + 386 1200 51-50
 Fax Int. + 386 1200 51-51

SK (Slovakia)

Schmachtl SK s.r.o.
 Tel. Int. + 421 2 58275600
 Fax Int. + 421 2 58275601

TH (Thailand)

Industrial Electrical Co. Ltd.
 Tel. Int. + 66 2 642 6700
 Fax Int. + 66 2 642 4250

TR (Turkey)

Leuze electronic San.ve Tic.Ltd.Sti.
 Tel. Int. + 90 216 456 6704
 Fax Int. + 90 216 456 3650

TW (Taiwan)

Great Colus Technology Co., Ltd.
 Tel. Int. + 886 2 2983 80-77
 Fax Int. + 886 2 2985 33-73

UA (Ukraine)

SV Altera OOO
 Tel. Int. + 38 044 4961888
 Fax Int. + 38 044 4961818

US + CA (United States + Canada)

Leuze electronic, Inc.
 Tel. Int. + 1 248 486-4466
 Fax Int. + 1 248 486-6699

ZA (South Africa)

Countapulse Controls (PTY) Ltd.
 Tel. Int. + 27 116 1575-56
 Fax Int. + 27 116 1575-13

The main menus

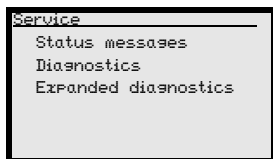
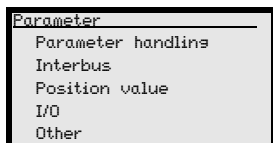
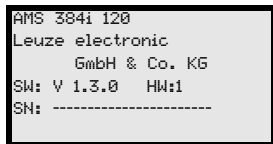

Device information - main menu

This menu item contains detailed information on

- device model,
- manufacturer,
- software and hardware version,
- serial number.

No entries can be made via the display.

Network information - main menu

Explanations of Ident code and baud rate.
No entries can be made via the display.

Status- and measurement data - main menu

- Display of status-, warning-, and error messages.
- Status overview of the switching inputs/outputs.
- Bar graph for the reception level.
- Activated interface.
- Measurement value.

No entries can be made via the display.
See "Indicators in the display" on page 36.

Parameter - main menu

- Configuration of the AMS.

See "Parameter menu" on page 41.

Language selection - main menu

- Selection of the display language.

See "Language selection menu" on page 44.

Service - main menu

- Display of status messages.
- Display of diagnostic data.

No entries can be made via the display.
See "Service menu" on page 45.

Device buttons:

-  Navigate upward/laterally
-  Navigate downward/laterally
-  ESCAPE leave
-  ENTER confirm

Input of values

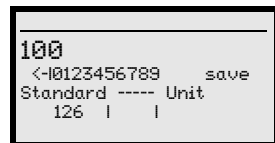

-  Delete character
-  Enter digit
-  Save input

1	General information	4
1.1	Explanation of symbols	4
1.2	Declaration of conformity	4
1.3	Description of functions AMS 384i	5
2	Safety notices	6
2.1	General safety notices	6
2.2	Safety standards	6
2.3	Intended use	6
2.4	Working safely	7
3	Fast commissioning / operating principle	9
3.1	Mounting the AMS 384i	9
3.1.1	Mounting the device	9
3.1.2	Mounting the reflector	9
3.2	Connecting the voltage supply	10
3.3	Display	10
3.4	AMS 384i on the Interbus	10
4	Specifications	11
4.1	Specifications of the laser measurement system	11
4.1.1	General specifications AMS 384i	11
4.1.2	Dimensioned drawing AMS 384i	13
4.1.3	Type overview AMS 384i	14
5	Installation and mounting	15
5.1	Storage, transportation	15
5.2	Mounting the AMS 384i	16
5.2.1	Optional mounting bracket	18
5.2.2	Mounting distances	19
5.3	Mounting the AMS 384i with laser beam deflector unit	20
5.3.1	Mounting the laser beam deflector unit with integrated mounting bracket	20
5.3.2	Dimensioned drawing of US AMS 01 deflector unit	21
5.3.3	Mounting the US 1 OMS deflector unit without mounting bracket	22

6	Reflectors	23
6.1	General information	23
6.2	Description of the reflective tape	23
6.2.1	Specifications of the self-adhesive foil	24
6.2.2	Specifications of the reflective tape on a metal plate	24
6.2.3	Dimensioned drawing of reflective tape on a metal plate	25
6.2.4	Specifications of heated reflectors	26
6.2.5	Dimensioned drawing of heated reflectors	27
6.3	Selecting reflector sizes	28
6.4	Mounting the reflector	29
6.4.1	General information	29
6.4.2	Mounting the reflector	29
6.4.3	Table of reflector pitches	32
7	Electrical connection	33
7.1	Safety notices for the electrical connection	33
7.2	PWR – voltage supply / switching input/output	34
7.3	Interbus BUS IN	34
7.4	Interbus BUS OUT	35
7.5	Service	35
8	Display and control panel AMS 384i	36
8.1	Structure of the control panel	36
8.2	Status display and operation	36
8.2.1	Indicators in the display	36
8.2.2	LED status displays	38
8.2.3	Control buttons	39
8.3	Menu description	40
8.3.1	The main menus	40
8.3.2	Parameter menu	41
8.3.3	Language selection menu	44
8.3.4	Service menu	44
8.4	Operation	45

9	Interbus interface	47
9.1	General information on Interbus	47
9.2	Interbus electrical connection	47
9.3	Interbus shielding and grounding concept	48
9.3.1	Interbus - voltage supply electrical connection	48
9.4	Interbus Ident number of the AMS 384 <i>i</i>	49
9.5	Interbus data format - 32-bit input data	49
9.5.1	Default settings of the Interbus interface	51
10	Diagnostics and troubleshooting	52
10.1	Service and diagnostics in the display of the AMS 384 <i>i</i>	52
10.1.1	Status messages	52
10.1.2	Diagnostics	53
10.1.3	Expanded diagnostics	53
10.2	General causes of errors	53
10.2.1	Power LED	53
10.3	Interface errors	53
10.3.1	BUS LED	53
10.4	Status display in the display of the AMS 384 <i>i</i>	54
11	Type overview and accessories	55
11.1	Type key	55
11.2	Type overview AMS 384 <i>i</i> (Interbus)	55
11.3	Overview of reflector types	56
11.4	Accessories	56
11.4.1	Accessory mounting bracket	56
11.4.2	Accessory deflector unit	56
11.4.3	Accessory M12 connector	56
11.4.4	Accessory ready-made cables for voltage supply	57
11.4.5	Accessory ready-made cables for Interbus	58
12	Maintenance	60
12.1	General maintenance information	60
12.2	Repairs, servicing	60
12.3	Disassembling, packing, disposing	60

1 General information

1.1 Explanation of symbols

The symbols used in this operating manual are explained below.



Attention!

This symbol precedes text messages which must strictly be observed. Failure to comply with this information results in injuries to personnel or damage to the equipment.



Attention Laser!

This symbol warns of possible danger caused by hazardous laser radiation.



Notice!

This symbol indicates text passages containing important information.

1.2 Declaration of conformity

The AMS 384*i* absolute measuring optical laser measurement system was designed and manufactured in accordance with applicable European directives and standards.

The AMS series is "UL LISTED" according to American and Canadian safety standards and fulfills the requirements of Underwriter Laboratories Inc. (UL).



Notice!

The Declaration of Conformity for these devices can be requested from the manufacturer.











The manufacturer of the product, Leuze electronic GmbH + Co. KG in D-73277 Owen/Teck, possesses a certified quality assurance system in accordance with ISO 9001.



1.3 Description of functions AMS 384*i*

The AMS 384*i* optical laser measurement system calculates distances to fixed as well as moving system parts. The distance to be measured is calculated according to the principle of the propagation time of radiated light. Here, the light emitted by the laser diode is reflected by a reflector onto the receiving element of the laser measurement system. The AMS 384*i* uses the "propagation time" of the light to calculate the distance to the reflector. The high absolute measurement accuracy of the laser measurement system and the fast integration time are designed for position control applications.

With the AMS 3xx*i* product series, Leuze electronic makes available a range of internationally relevant interfaces. Note that each interface version listed below corresponds to a different AMS 3xx*i* model.

	AMS 304<i>i</i>
	AMS 348<i>i</i>
	AMS 355<i>i</i>
	AMS 358<i>i</i>
	AMS 335<i>i</i>
	AMS 338<i>i</i>
	AMS 308<i>i</i>
	AMS 384<i>i</i>
	AMS 301<i>i</i>
	AMS 300<i>i</i>

2 Safety notices

2.1 General safety notices

Documentation

All entries in this technical description must be heeded, in particular those in section "Safety notices". Keep this technical description in a safe place. It should be available at all times.

Safety regulations

Observe the locally applicable legal regulations and the rules of the employer's liability insurance association.

Repair

Repairs must only be carried out by the manufacturer or an authorized representative.

2.2 Safety standards

The devices of the series AMS 384*i* were developed, manufactured and tested in accordance with the applicable safety standards. They correspond to the state of the art.

2.3 Intended use

The AMS 384*i*... device series is an absolute measuring system based on laser technology. The devices use a visible optical laser to measure distances of up to 300m contactlessly. The laser is designed so that distance measurements are made against a reflector.



Attention!

The protection of personnel and the device is guaranteed only if the device is operated in a manner corresponding to its intended use.

Areas of application

The AMS 384*i*... is suitable for the following areas of application:

- Distance measurements for determining the position of automated, moving plant components such as:
 - Travel and lifting axes of high-bay storage devices
 - Gantry crane bridges and their trolleys
 - Repositioning units
 - Lifts
 - Electroplating plants

2.4 Working safely



Attention!

Access to or changes on the device, except where expressly described in this operating manual, are not authorized.

The device must not be opened. Failure to comply will render the guarantee void. Warranted features cannot be guaranteed after the device has been opened.

Safety regulations

Observe the locally applicable legal regulations and the rules of the employer's liability insurance association.



Attention!

The AMS 384*i*... is not a safety module acc. to EU machinery directives.

Qualified personnel

Mounting, commissioning and maintenance of the device must only be carried out by qualified personnel. Electrical work must be carried out by a certified electrician.



Attention, laser radiation!

The AMS 384*i* operates with a red light laser of class 2 acc. to EN 60825-1. If you look into the beam path over a longer time period, the retina of your eye may be damaged!

Never look directly into the beam path!

Do not point the laser beam of the AMS 384*i* at persons!

When mounting and aligning the AMS 384*i*, avoid reflections of the laser beam off of reflective surfaces!

Heed the laser safety regulations according to DIN EN 60825-1 in their most current version! The output power of the laser beam at the reading window is at most 4.0mW acc. to EN 60825-1. The average laser power is less than 1 mW in accordance with laser class 2 as well as CDRH class 2.

The AMS 384*i* uses a laser diode with low power in the visible red light range with an emitted wavelength of 650 ... 690nm.



Attention!

CAUTION! The use of operating and adjusting devices other than those specified here or carrying out of differing procedures may lead to dangerous exposure to radiation.

The housing of the AMS 384*i* has been provided with the following labeling:

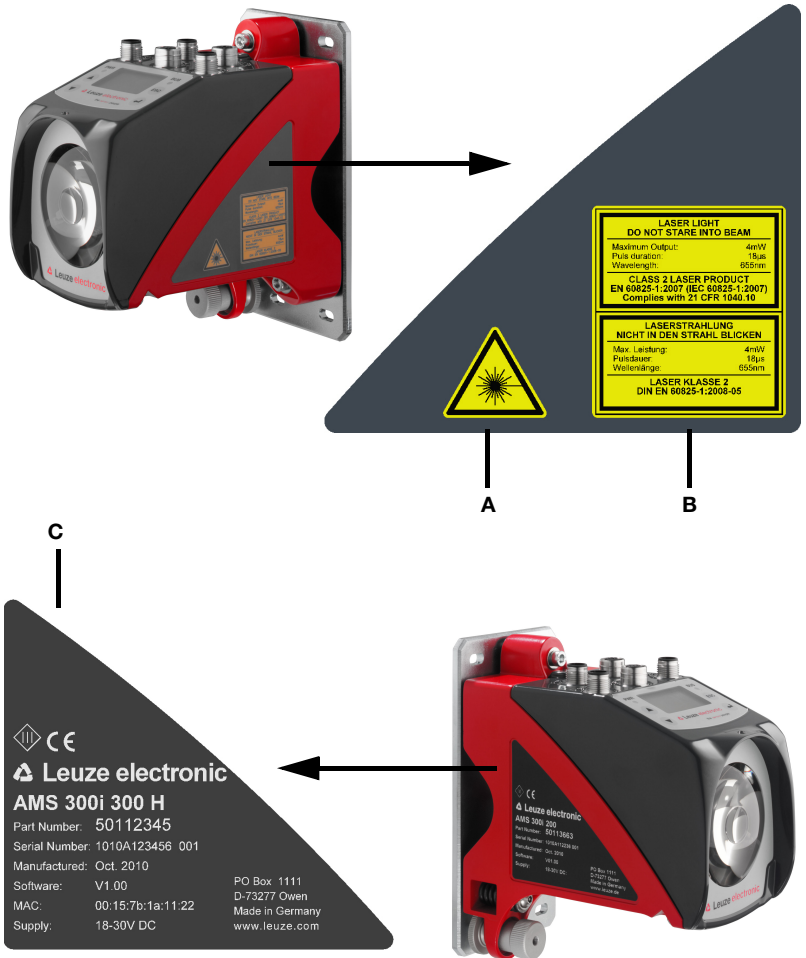

- A** Hazard warning & logotype
- B** Warning and certification plate
- C** Name plate with part no., version no., date of manufacture and serial no.
For EtherNet-based devices, the MAC ID is specified on the name plate.
Please note that the shown name plate is for illustration purposes only; the contents do not correspond to the original.

Figure 2.1: Location of the name plate on the AMS 384*i*

3 Fast commissioning / operating principle

**Notice!**

Below, you will find a **short description for the initial commissioning** of the AMS 384*i*. Detailed explanations for the listed points can be found throughout the handbook.

3.1 Mounting the AMS 384*i*

The AMS 384*i* and the corresponding reflector are mounted on two mutually opposing, plane-parallel, flat walls.



Figure 3.1: Schematic illustration of mounting

**Attention!**

For error-free position measurement, there must be an unobstructed line-of-sight between the AMS 384*i* and the reflector.

3.1.1 Mounting the device

The laser is mounted on a vertical wall using 4 screws (M5).

Alignment is performed using 2 adjustment screws. Adjust so that the laser light spot is positioned at the center of the reflector. The alignment is to be secured with the knurled nut and locked with the M5 nut.

Further information can be found in chapter 5.2 and chapter 5.3.

3.1.2 Mounting the reflector

The reflector is mounted on a vertical wall with 4 screws (M5). The reflector is angled using the included shims. Incline the reflector by approx. 1°.

Detailed information can be found in chapter 6.4.



3.2 Connecting the voltage supply

The laser measurement system is connected using M12 connectors. The voltage supply is connected via the **PWR** M12 connection.

Detailed information can be found in chapter 7.

3.3 Display

Once the laser measurement system is supplied with voltage, the device status as well as the measured position values can be read on the display. The display automatically switches to the display of the measurement values.

Use the up/down buttons   to the left of the display to read and change a wide range of data and parameters.

Depending on connected interface, the network address or IP addresses must be configured via the display.

Detailed information can be found in chapter 8.

3.4 AMS 384*i* on the Interbus

The laser measurement system is delivered with preset Interbus parameters. The AMS 384*i* is classified with Ident code 32_H, which is stored in the control. The AMS 384*i* is connected via the BUS IN M12 connection or, in the case of a continuing network, via BUS OUT.

Detailed information can be found in chapter 9.

4 Specifications

4.1 Specifications of the laser measurement system

4.1.1 General specifications AMS 384*i*

Measurement data	AMS 384 <i>i</i> 40 (H)	AMS 384 <i>i</i> 120 (H)	AMS 384 <i>i</i> 200 (H)	AMS 384 <i>i</i> 300 (H)
Measurement range	0.2 ... 40m	0.2 ... 120m	0.2 ... 200m	0.2 ... 300m
Accuracy	± 2mm	± 2mm	± 3mm	± 5mm
Consistency ¹⁾	0.3mm	0.5mm	0.7mm	1.0mm
Light spot diameter	≤ 40mm	≤ 100mm	≤ 150mm	≤ 225mm
Measurement value output			1,7ms	
Integration time			8ms	
Resolution		adjustable, see chapter of the individual interfaces		
Temperature drift			≤ 0.1 mm/K	
Ambient temperature sensitivity			1 ppm/K	
Air pressure sensitivity			0.3 ppm/hPa	
Traverse rate			≤ 10 m/s	
Electrical data				
Supply voltage V_{in} ²⁾			18 ... 30VDC	
Current consumption			without device heating: ≤ 250mA / 24VDC with device heating: ≤ 500mA / 24VDC	
Optical data				
Transmitter		laser diode, red light, wavelength 650 ... 690nm		
Laser class		2 acc. to EN 60825-1, CDRH		
Laser life expectancy ³⁾		average temperature / year		50°C: 23.000h 25°C: 60.000h 20°C: 75.000h 10°C: 120.000h
Interfaces				
InterBus remote bus			500kbit/s / 2Mbit/s	
Operating and display elements				
Keyboard			4 buttons	
Display		monochromatic graphical display, 128 x 64 pixels		
LED		2 LEDs, two-colored		
Inputs/outputs				
Quantity			2, programmable	
Input		protected against polarity reversal		
Output		max. 60mA, short-circuit proof		

Mechanical data

Housing	cast zinc and aluminum
Optics	glass
Weight	approx. 2.45 kg
Protection class	IP 65 acc. to EN 60529 ⁴⁾

Environmental conditions

Operating temperature	
without device heating	-5 °C ... +50 °C
with device heating	-30 °C ... +50 °C ⁵⁾
Storage temperature	-30 °C ... +70 °C
Air humidity	max. 90% rel. humidity, non-condensing

Mechanical/electrical loading capacity

Vibrations	acc. to EN 60068-2-6
Noise	acc. to EN 60060-2-64
Shock	acc. to EN 60068-2-27
EMC	acc. to EN 61000-6-2 and EN 61000-6-4 ⁶⁾

- 1) Statistical error: 1 sigma; minimum switch-on time: 2 min.
- 2) For UL applications: only for use in "Class 2" circuits acc. to NEC.
- 3) Switching off the laser diode during system downtime can considerably extend the life expectancy of the device. The laser life expectancy is calculated using a failure rate of 1%.
- 4) With screwed-on M12 plugs or mounted caps.
- 5) With devices with heating, the switch on/off area of the internal heating can be extended to prevent condensation from forming. A 100% prevention of the formation of condensation cannot be guaranteed due to the limited heating capacity of the AMS 384*f*.
- 6) This is a Class A product. In a domestic environment this product may cause radio interference, in which case the operator may be required to take adequate measures.

4.1.2 Dimensioned drawing AMS 384*i*

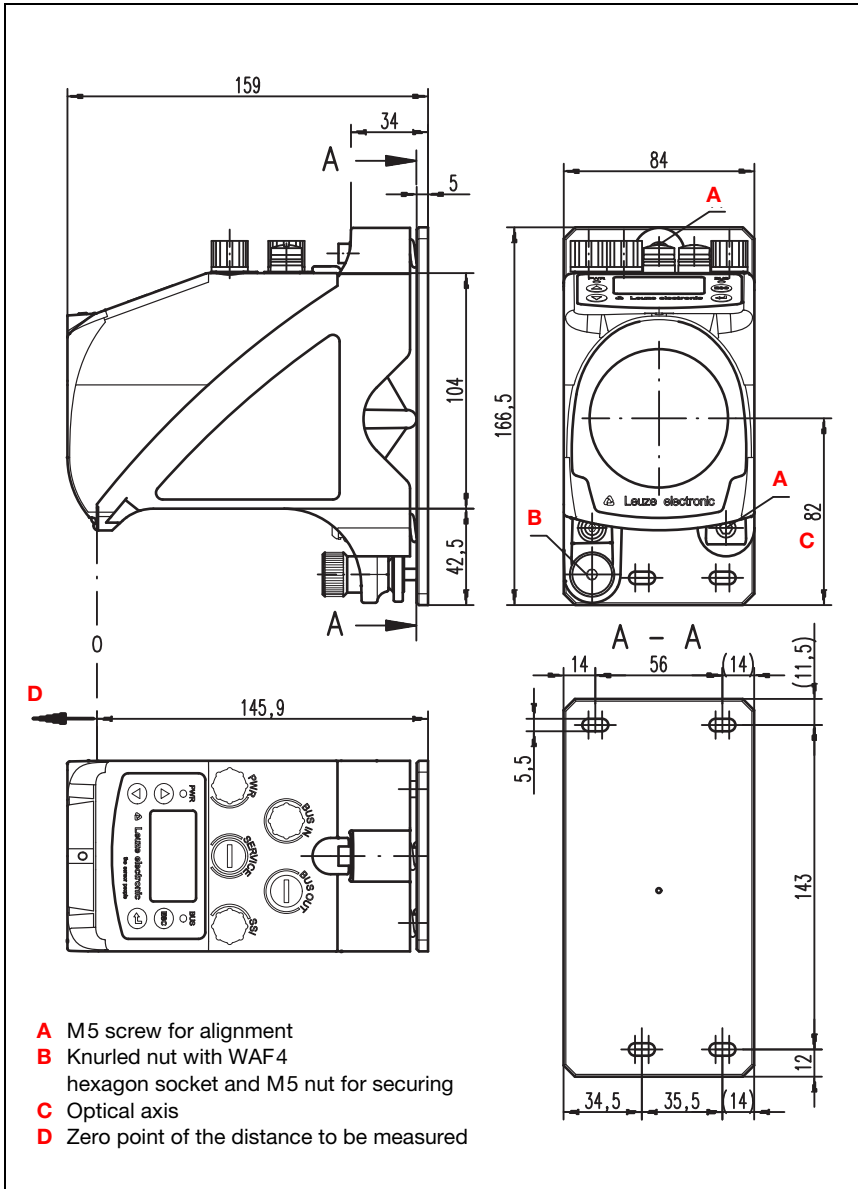

Figure 4.1: Dimensioned drawing AMS 384*i*

4.1.3 Type overview AMS 384*i*

*AMS 384*i* (Interbus)*

Type designation	Description	Part No.
AMS 384 <i>i</i> 40	40 m operating range, Interbus interface	50113733
AMS 384 <i>i</i> 120	120 m operating range, Interbus interface	50113734
AMS 384 <i>i</i> 200	200 m operating range, Interbus interface	50113735
AMS 384 <i>i</i> 300	300 m operating range, Interbus interface	50113736
AMS 384 <i>i</i> 40 H	40 m operating range, Interbus interface, integrated heating	50113737
AMS 384 <i>i</i> 120 H	120 m operating range, Interbus interface, integrated heating	50113738
AMS 384 <i>i</i> 200 H	200 m operating range, Interbus interface, integrated heating	50113739
AMS 384 <i>i</i> 300 H	300 m operating range, Interbus interface, integrated heating	50113740

Table 4.1: Type overview AMS 384*i*

5 Installation and mounting

5.1 Storage, transportation



Attention!

When transporting or storing, package the device so that it is protected against collision and humidity. Optimum protection is achieved when using the original packaging. Heed the required environmental conditions specified in the technical data.

Unpacking

- ✎ Check the packaging for any damage. If damage is found, notify the post office or shipping agent as well as the supplier.
- ✎ Check the delivery contents using your order and the delivery papers:
 - Delivered quantity
 - Device type and model as indicated on the nameplate
 - Brief manual

The name plate provides information as to what AMS 384*i* type your device is. For specific information, please refer to chapter 11.2.

Name plates



Figure 5.1: Device name plate using the AMS 300*i* as an example



Notice!

Please note that the shown name plate is for illustration purposes only; the contents do not correspond to the original.

- ✎ Save the original packaging for later storage or shipping.

If you have any questions concerning your shipment, please contact your supplier or your local Leuze electronic sales office.

↳ Observe the applicable local regulations when disposing of the packaging materials.

5.2 Mounting the AMS 384*i*

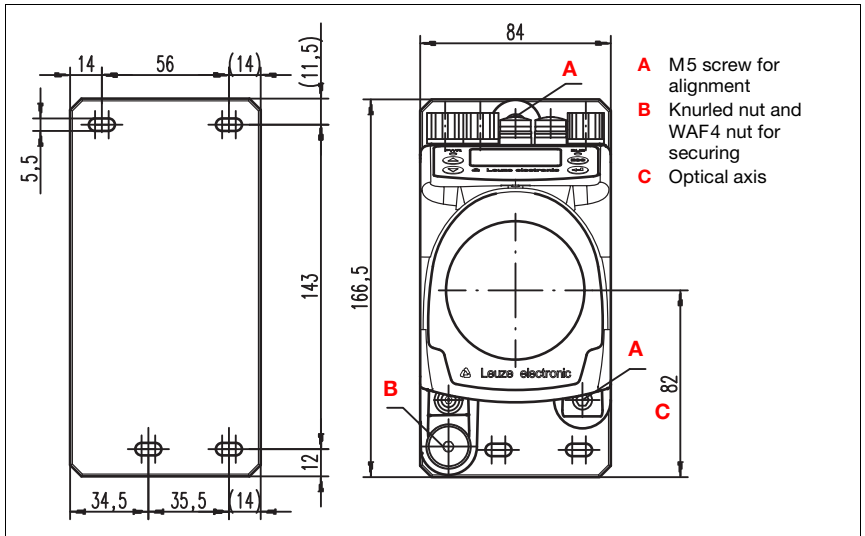

Figure 5.2: Mounting the device

The AMS 384*i* and the corresponding reflector are mounted on two mutually opposing, plane-parallel, flat walls or system parts. For error-free position measurement, there must be an unobstructed line-of-sight connection between the AMS 384*i* and the reflector.

Use M5 screws to fasten the laser measurement system. Secure the screws with a toothed lock washer to protect against loosening caused by vibrations.

Aligning the laser light spot in the center of the reflector

The laser light spot has to be aligned so that it always hits the center of the opposing reflector, both at close range as well as at the maximum measurement distance. **To align, use the two M5 Allen screws** ("A" in figure 5.2). When aligning please ensure that the knurled nut and the lock nut ("B" in figure 5.2) are opened wide.

***Attention!***

To prevent the laser measurement system from moving out of alignment during continuous operation, subsequently hand-tighten the knurled nut and counterlock with the WAF4 nut ("B" in figure 5.2). Knurled nut and nut must not be tightened until alignment has been completed.

***Attention!***

The device must not be opened. Failure to comply will render the guarantee void. Warranted features cannot be guaranteed after the device has been opened.

5.2.1 Optional mounting bracket

A mounting bracket for mounting the AMS 384*i* on a flat, horizontal surface is available as an optional accessory.

Type designation: MW OMS/AMS 01

Part No.: 50107255

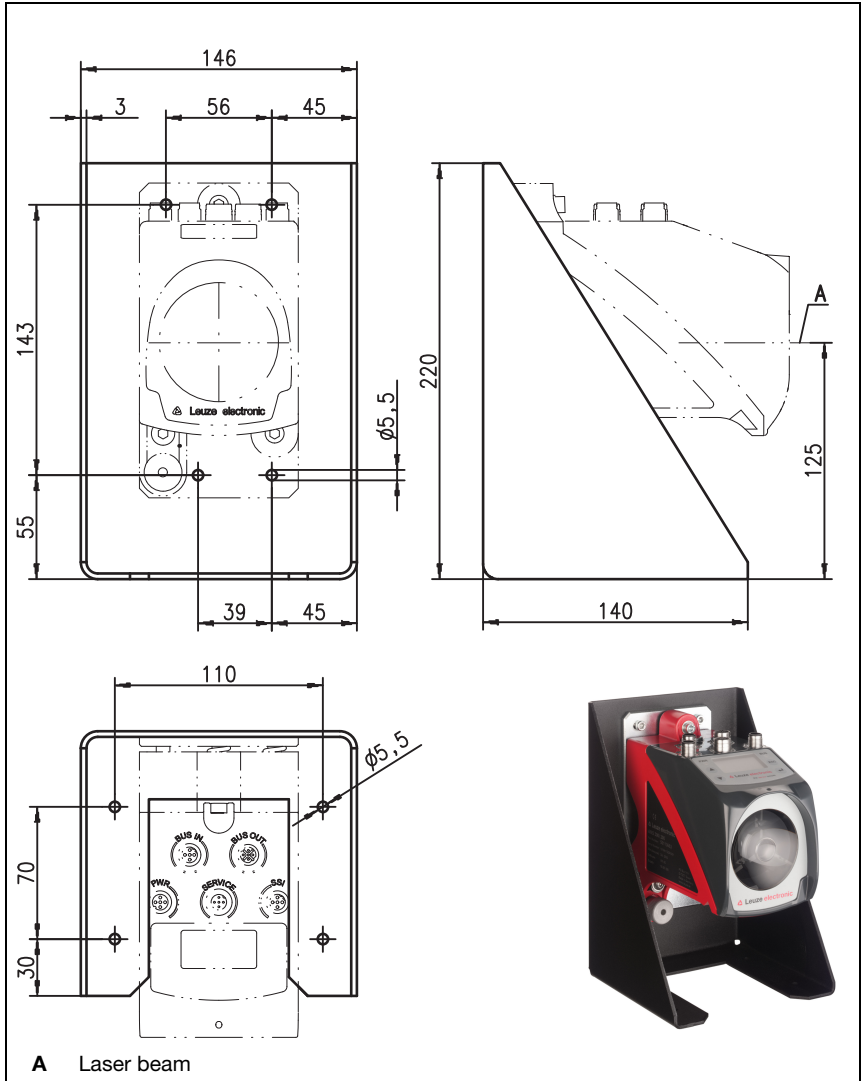

Figure 5.3: Optional mounting bracket



5.2.2 Mounting distances

Minimum parallel spacing between adjacent AMS 384*i*

The smallest-possible parallel spacing between adjacent AMS 384*i* is determined by the maximum measured distance as well as by the properties of the reflector. To prevent adjacent devices from interfering with each other the parallel distance of the laser light spots on the reflector is crucial.

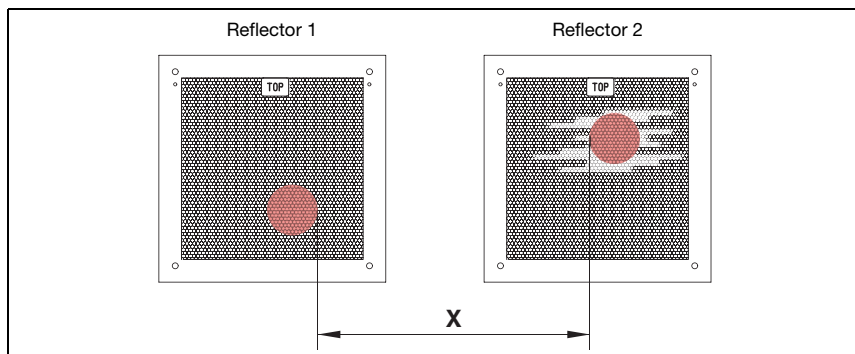

Figure 5.4: Minimum parallel spacing X between adjacent AMS 384*i*

Min. parallel spacing of laser light spot $X = 100 \text{ mm} + (\text{max. measurement distance in mm} \times 0.01)$.



Notice!

Please note that travel tolerances could cause the two laser light spots to move towards each other.

If both AMS 384*i* are optically separated from one another, e.g., if installed in different shelf alleys, the parallel spacing can be selected smaller, as there is no mutual interference in this case.

Minimum distance to an adjacent DDLS 200 optical data transmission device

The optical data transceivers of the DDLS 200 series and the AMS 384*i* do not mutually interfere with one another. Depending on the size of the used reflector, the optical data transceiver can be mounted with a minimum mounting spacing of 100 mm to the AMS 384*i*. The mounting spacing is independent of the distance.

5.3 Mounting the AMS 384*i* with laser beam deflector unit

General information

The two available deflector units are used for the 90° deflection of the laser beam, see "Accessory deflector unit" on page 56.



Attention!

The deflector units are designed for a maximum range of 40m. Longer distances on request.

5.3.1 Mounting the laser beam deflector unit with integrated mounting bracket

The AMS 384*i* is screwed onto the mechanism of the US AMS 01 deflector unit. The mirror can be mounted for three deflection directions:

1. Upward beam deflection
2. Beam deflection to the left
3. Beam deflection to the right

The deflector unit is mounted on plane-parallel, flat walls or plant components. For error-free position measurement, there must be an interruption-free line-of-sight between the AMS 384*i*... and the deflection mirror as well as between the mirror and the reflector.

Use the M5 screws to mount the deflector unit. Secure the screws with a toothed lock washer to protect against loosening caused by vibrations.

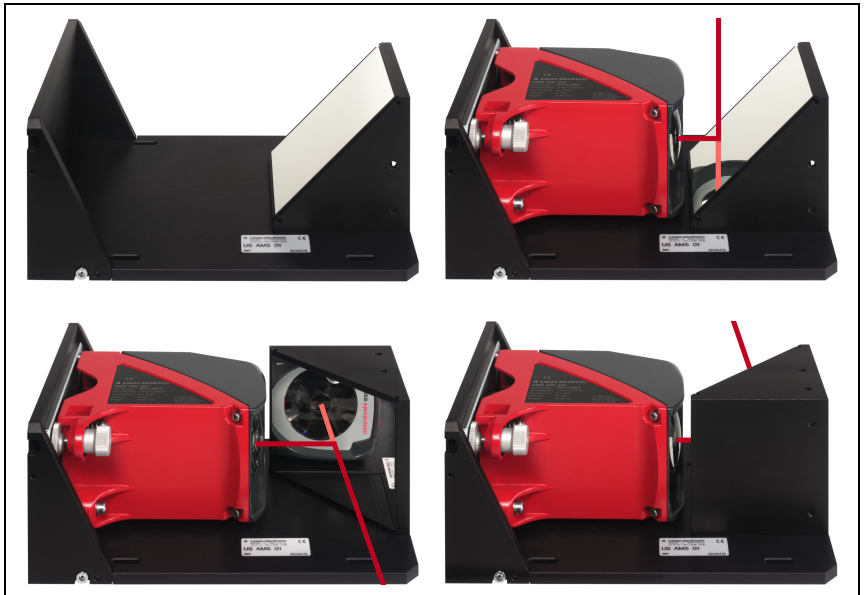

Figure 5.5: Mounting variants of the US AMS 01 laser beam deflector unit

5.3.2 Dimensioned drawing of US AMS 01 deflector unit

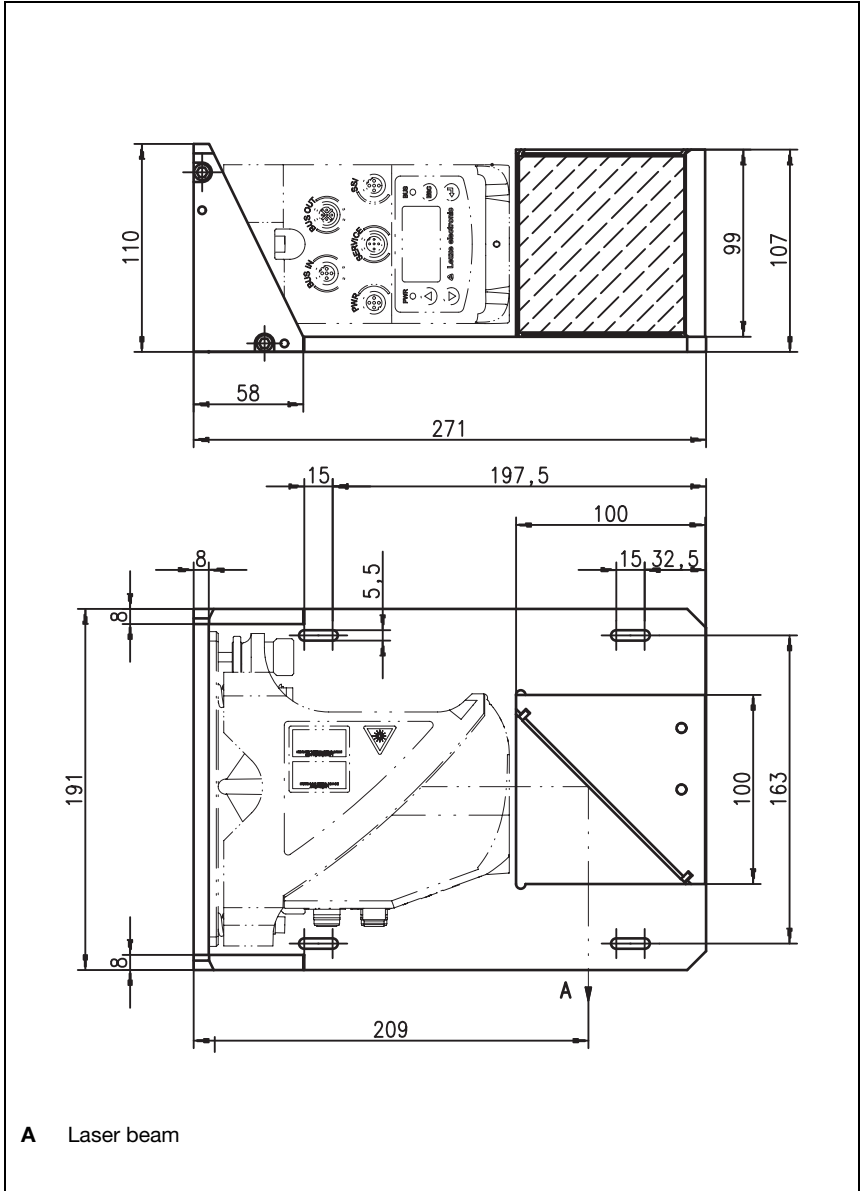

Figure 5.6: Dimensioned drawing of US AMS 01 deflector unit

5.3.3 Mounting the US 1 OMS deflector unit without mounting bracket

The US 1 OMS deflector unit and the AMS 384*i* are mounted separately.



Notice!

When mounting, make certain that the laser light spot of the AMS 384*i* is aligned in the center of the deflection mirror.

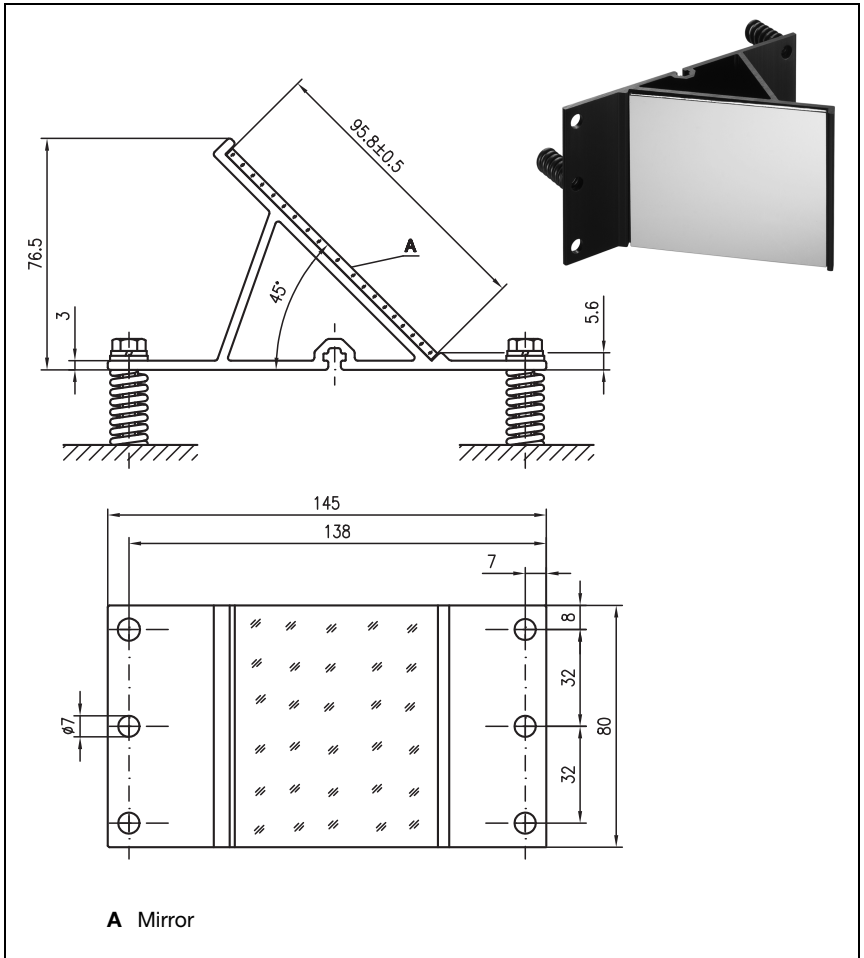

Figure 5.7: Photo and dimensioned drawing of the US 1 OMS deflector unit

Alignment of the laser light spot on the reflector is performed as described in chapter 5.2.

6 Reflectors

6.1 General information

The AMS 384*i* measures distances against a reflective tape specified by Leuze electronic. All provided specifications for the AMS 384*i*, such as the operating range or accuracy, can only be achieved with the reflective tape specified by Leuze electronic.

The reflective tapes are available as adhesive tapes, affixed to a metal plate and with an integrated heater especially for use at low temperatures. Reflective tapes with heating have the designation "**Reflective tape ...x...-H**", where "**H**" is an abbreviation for the heating variant.

The reflective tapes/reflectors must be ordered separately. The choice of size is left to the user. In chapter 6.3, recommendations on reflector size are provided as a function of the distance that is to be measured. In any case, the user must check to determine whether the recommendation is suitable for the respective application.

6.2 Description of the reflective tape

The reflective tape consists of a white, microprism-based reflective material. The microprisms are protected with a highly transparent, hard protective layer.

Under certain circumstances, the protective layer may lead to surface reflections. The surface reflections can be directed past the AMS 384*i* by positioning the reflective tape at a slight incline. The inclination of the reflective tape/reflectors is described in chapter 6.4.2. The required pitch can be found in table 6.1 "Reflector pitch resulting from spacer sleeves" on page 32.

The reflective tapes are provided with a protective foil that can easily be pulled off. This must be removed from the reflector before the complete system is put into operation.

6.2.1 Specifications of the self-adhesive foil

	Part		
Type designation	Reflective tape 200x200-S	Reflective tape 500x500-S	Reflective tape 914x914-S
Part No.	50104361	50104362	50108988
Foil size	200x200mm	500x500mm	914x914mm
Recommended application temperature for adhesive tape	+5°C ... +25°C		
Temperature resistance, affixed	-40°C ... +80°C		
Mounting surface	The mounting surface must be clean, dry and free of grease.		
Cutting the tape	Cut with a sharp tool, always on the side of the prism structure.		
Cleaning	Do not use any agents that act with a grinding effect. A conventional household detergent can be used as a cleaning agent. Rinse with clear water and dry the surface.		
Storing the foil	Store in a cool and dry place.		

6.2.2 Specifications of the reflective tape on a metal plate

The reflective tape is affixed to a metal plate. Included with the metal plate are spacers for positioning at an incline - for avoiding surface reflections - (see chapter 6.4.2 "Mounting the reflector").

	Part		
Type designation	Reflective tape 200x200-M	Reflective tape 500x500-M	Reflective tape 914x914-M
Part No.	50104364	50104365	50104366
Foil size	200x200mm	500x500mm	914x914mm
Outer dimensions of the metal plate	250x250mm	550x550mm	964x964mm
Weight	0.8kg	4kg	25kg
Cleaning	Do not use any agents that act with a grinding effect. A conventional household detergent can be used as a cleaning agent. Rinse with clear water and dry the surface.		
Storing the reflector	Store in a cool and dry place.		

6.2.3 Dimensioned drawing of reflective tape on a metal plate

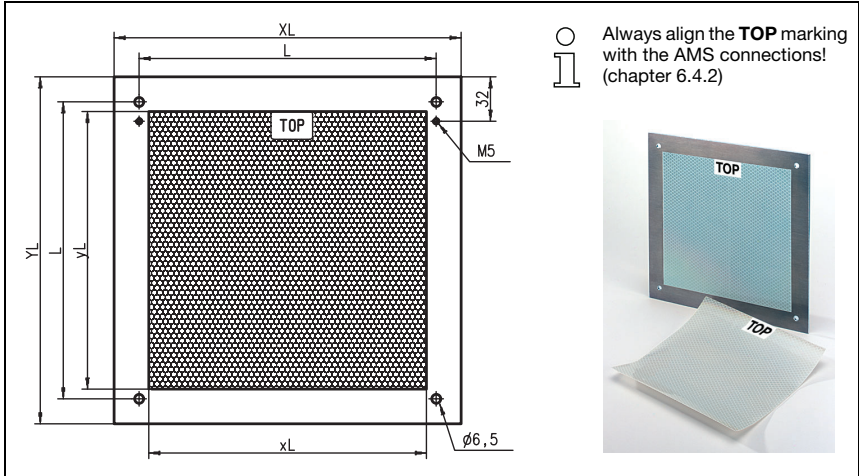

Figure 6.1: Dimensioned drawing of reflectors

Part	Reflective tape (mm)		Reflector plate (mm)		
	xL	yL	XL	YL	L
Reflective tape 200x200-M	200	200	250	250	214
Reflective tape 500x500-M	500	500	550	550	514
Reflective tape 914x914-M	914	914	964	964	928

6.2.4 Specifications of heated reflectors

The reflective tape is affixed to a heated, thermally insulated base. The insulation results in a very high energetic efficiency.

Only the reflective tape is kept at the specified temperature by the integrated heater. Through the insulation on the back, the generated heat cannot be transferred via the steel construction. Energy costs are greatly reduced in the case of continuous heating.

	Part		
Type designation	Reflective tape 200x200-H	Reflective tape 500x500-H	Reflective tape 914x914-H
Part No.	50115020	50115021	50115022
Voltage supply	230VAC		
Power	100W	150W	500W
Current consumption	~ 0.5A	~ 1A	~ 2.5A
Length of the supply line	2 m		
Size of the reflective tape	200x200mm	500x500mm	914x914mm
Outer dimensions of the base material	250x250mm	550x550mm	964x964mm
Weight	0.5kg	2.5kg	12kg
Temperature control	Controlled heating with the following switch-on and switch-off temperatures, measured at the reflector surface.		
Switch-on temperature	~ 5°C		
Switch-off temperature	~ 20°C		
Operating temperature	-30°C ... +70°C		
Storage temperature	-40°C ... +80°C		
Air humidity	Max. 90%, non-condensing		
Cleaning	Do not use any agents that act with a grinding effect. A conventional household detergent can be used as a cleaning agent. Rinse with clear water and dry the surface.		
Storing the reflector	Store in a cool and dry place.		

6.2.5 Dimensioned drawing of heated reflectors

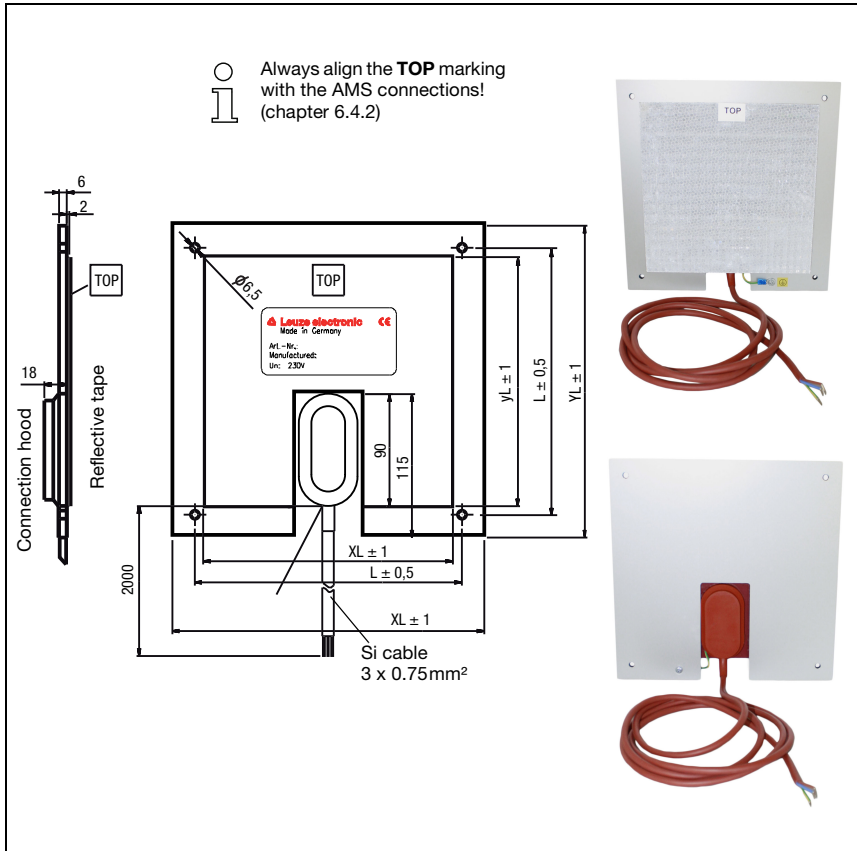

Figure 6.2: Dimensioned drawing of heated reflectors

Part	Reflective tape (mm)		Insulated base plate (mm)		
	xL	yL	XL	YL	L
Reflective tape 200x200-H	200	200	250	250	214
Reflective tape 500x500-H	500	500	550	550	514
Reflective tape 914x914-H	914	914	964	964	928

6.3 Selecting reflector sizes

Depending on system design, the reflector can be mounted so that it travels on the vehicle or it can be mounted at a fixed location.



Attention!

The reflector sizes shown below are a recommendation from Leuze electronic for on-vehicle mounting of the AMS 384*i*. For stationary mounting of the AMS 384*i*, a smaller reflector is generally sufficient for all measurement distances.

On the basis of the system planning and design, always check whether mechanical travel tolerances may require the use of a reflector larger than that which is recommended. This applies, in particular, when the laser measurement system is mounted on a vehicle. During travel, the laser beam must reach the reflector without interruption. For on-vehicle mounting of the AMS 384*i*, the reflector size must accommodate any travel tolerances that may arise and the associated "wandering" of the light spot on the reflector.

Overview of reflector types

Recommended reflector sizes			
AMS 384 <i>i</i> selection (Operating range in m)	Recommended reflector size (H x W)	Type designation ...-S = Self-adhesive ...-M = metal plate ...-H = heating	Part No.
AMS 384 <i>i</i> 40 (max. 40m)	200x200 mm	Reflective tape 200x200-S Reflective tape 200x200-M Reflective tape 200x200-H	50104361 50104364 50115020
AMS 384 <i>i</i> 120 (max. 120m)	500x500 mm	Reflective tape 500x500-S Reflective tape 500x500-M Reflective tape 500x500-H	50104362 50104365 50115021
AMS 384 <i>i</i> 200 (max. 200m)	749x914 mm 914x914 mm	Reflective tape 749x914-S Reflective tape 914x914-M Reflective tape 914x914-S Reflective tape 914x914-H	50104363 50104366 50108988 50115022
AMS 384 <i>i</i> 300 (max. 300m)	749x914 mm 914x914 mm	Reflective tape 749x914-S Reflective tape 914x914-M Reflective tape 914x914-S Reflective tape 914x914-H	50104363 50104366 50108988 50115022

6.4 Mounting the reflector

6.4.1 General information

Self-adhesive reflective tapes

The reflective tapes of the "Reflective tape ...x...-S" self-adhesive series must be affixed to a flat, clean and grease-free surface. We recommend using a separate metal plate, which is to be provided on-site.

As described in table 6.1, the reflective tape must be angled.

Reflective tapes on metal

The reflective tapes of the "Reflective tape ...x...-M" series are provided with corresponding mounting holes. Spacer sleeves are provided in the packet for achieving the necessary pitch angle. For further information see table 6.1.

Heated reflectors

The reflective tapes of the "Reflective tape ...x...-H" series are provided with corresponding mounting holes. Due to the voltage supply affixed on the rear, the reflector cannot be mounted flat. Included in the package are four distance sleeves in two different lengths. Use the distance sleeves to achieve a base separation to the wall as well as the necessary pitch for avoiding surface reflection. For further information see table 6.1.

The reflector is provided with a 2 m-long connection cable for supplying with 230VAC. Connect the cable to the closest power outlet. Observe the current consumptions listed in the specifications.



Attention!

Connection work must be carried out by a certified electrician.

6.4.2 Mounting the reflector

The combination of laser measurement system and reflective tape/reflector is mounted so that the laser light spot hits the tape as centered as possible and without interruption.

For this purpose, use the alignment elements provided on the AMS 384*i*... (see chapter 5.2 "Mounting the AMS 384*i*"). If necessary, remove the protective foil from the reflector.



Attention!

The "TOP" label mounted on the reflectors should be aligned the same as the connections of the AMS 384*i*.

Example:

*If the AMS 384*i* is mounted so that the M12 connections are on the top, the "TOP" label of the reflector is also on the top. If the AMS 384*i* is mounted so that the M12 connections are on the side, the "TOP" label of the reflector is also on the side.*



Notice!

The reflector must be angled. To do this, use the spacer sleeves. Angle the reflectors so that the surface reflections of the foil seal are deflected to the left, right or upwards. Avoid a downward pitch, as additional reflections may occur on the running rails. chapter 6.4.3 gives the correct pitch with respect to the reflector size and, thus, the length of the spacers.

Reflective tapes ...-S and ...-M

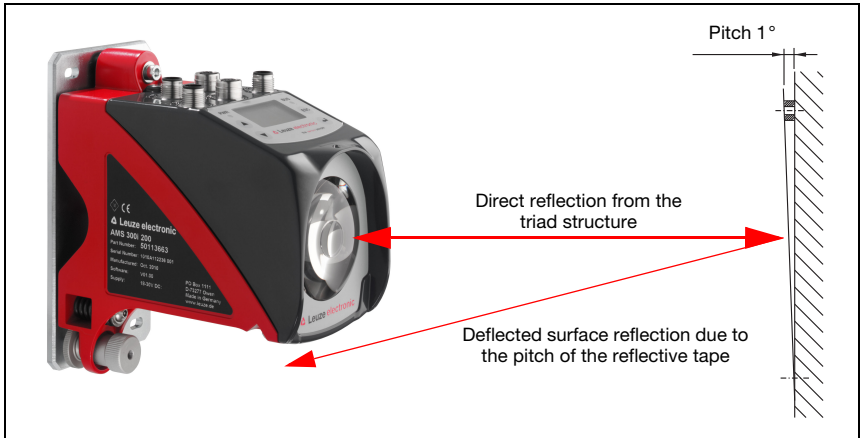

Figure 6.3: Reflector mounting

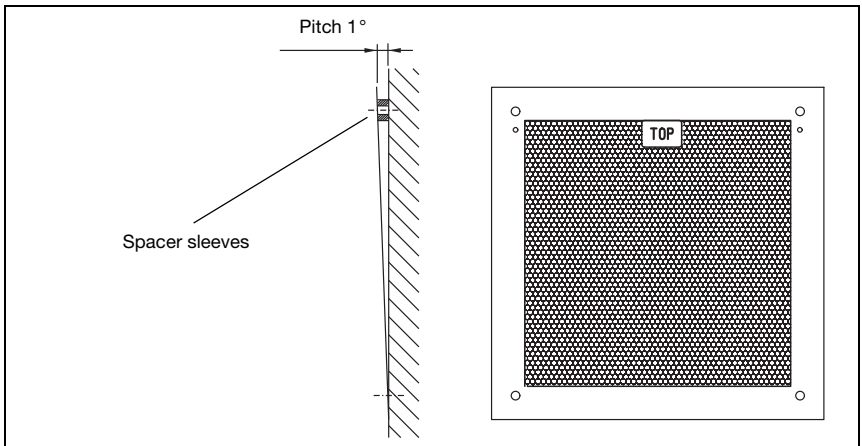

Figure 6.4: Pitch of the reflector

Reflective tapes ...-H

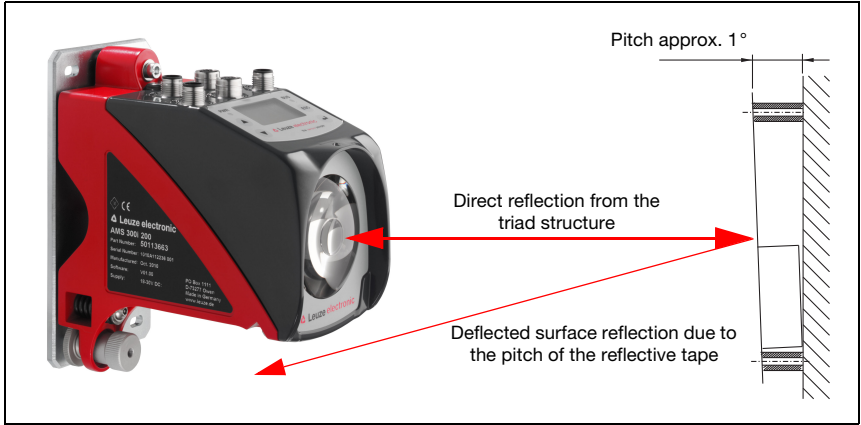

Figure 6.5: Mounting of heated reflectors

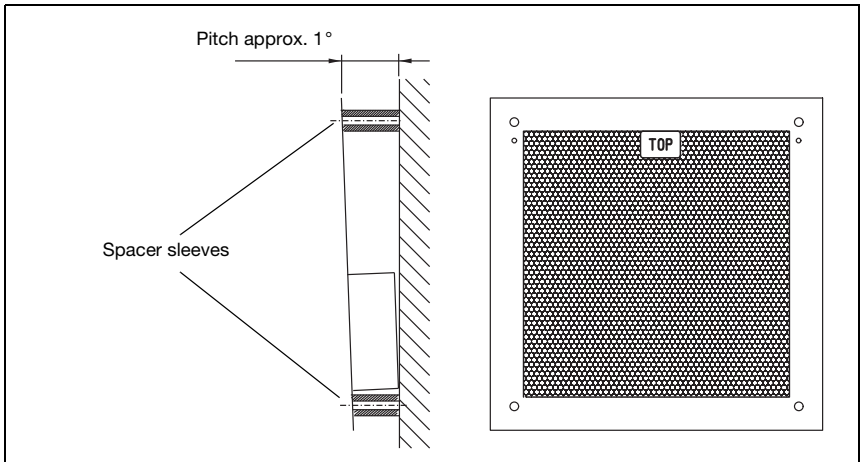

Figure 6.6: Pitch of the heated reflector

6.4.3 Table of reflector pitches

Reflector type	Pitch resulting from spacer sleeves ¹⁾	
Reflective tape 200x200-S Reflective tape 200x200-M	2 x 4mm	
Reflective tape 200x200-H	2 x 15mm	2 x 20mm
Reflective tape 500x500-S Reflective tape 500x500-M	2 x 10mm	
Reflective tape 500x500-H	2 x 15mm	2 x 25mm
Reflective tape 749x914-S	2 x 20mm	
Reflective tape 914x914-S Reflective tape 914x914-M	2 x 20mm	
Reflective tape 914x914-H	2 x 15mm	2 x 35mm

1) Spacer sleeves are included in the delivery contents of reflective tape ...-M and ...-H

Table 6.1: Reflector pitch resulting from spacer sleeves



Notice!

Reliable function of the AMS 384i and, thus, max. operating range and accuracy can only be achieved with the reflective tape specified by Leuze electronic. No function can be guaranteed if other reflectors are used!

7 Electrical connection

The AMS 384*i* laser measurement systems are connected using variously coded M12 connectors. This ensures unique connection assignments.



Notice!

The corresponding mating connectors and ready-made cables are available as accessories for all cables. For further information, see chapter 11 "Type overview and accessories".



Figure 7.1: Connections of the AMS 384*i*

7.1 Safety notices for the electrical connection



Attention!

Before connecting the device, be sure that the supply voltage agrees with the value printed on the name plate.

The device may only be connected by a qualified electrician.

Ensure that the functional earth (FE) is connected correctly. Unimpaired operation is only guaranteed when the functional earth is connected properly.

If faults cannot be corrected, the device should be removed from operation and protected against possible use.



Attention!

For UL applications, use is permitted exclusively in Class 2 circuits according to NEC (National Electric Code).



The laser measurement systems are designed in accordance with safety class III for supply by PELV (protective extra-low voltage with reliable disconnection).



Notice!

Protection class IP65 is achieved only if the connectors and caps are screwed into place!

Described in detail in the following are the individual connections and pin assignments.

7.2 PWR – voltage supply / switching input/output

PWR (5-pin plug, A-coded)			
	Pin	Name	Remark
	1	VIN	Positive supply voltage +18 ... +30VDC
	2	I/O 1	Switching input/output 1
	3	GND	Negative supply voltage 0VDC
	4	I/O 2	Switching input/output 2
	5	FE	Functional earth
	Thread	FE	Functional earth (housing)

Table 7.1: Pin assignment PWR

Further information on configuring the input/output can be found in chapter 8 and chapter 9.

7.3 Interbus BUS IN

BUS IN (5-pin plug, B-coded)			
	Pin	Name	Remark
	1	DO	From the Interbus master
	2	/DO	From the Interbus master, inverted
	3	DI	To the Interbus master
	4	/DI	To the Interbus master, inverted
	5	Data GND	Data Ground
	Thread	SHIELD	Shield via RC element on the housing

Table 7.2: Pin assignments for BUS IN

7.4 Interbus BUS OUT

BUS OUT (5-pin socket, B-coded)			
	Pin	Name	Remark
 <p>BUS OUT</p> <p>/DO</p> <p>2</p> <p>DO 1 3 DI</p> <p>4</p> <p>/DI</p> <p>Data GND</p> <p>M12 socket (B-coded)</p>	1	DO	From the Interbus master
	2	/DO	From the Interbus master, inverted
	3	DI	To the Interbus master
	4	/DI	To the Interbus master, inverted
	5	Data GND	Data Ground
	Thread	SHIELD	Shield directly on the housing

Table 7.3: Pin assignment BUS OUT

7.5 Service

Service (5-pin socket, A-coded)			
	Pin	Name	Remark
 <p>SERVICE</p> <p>RS232-TX</p> <p>2</p> <p>NC 1 3 GND</p> <p>4</p> <p>RS232-RX</p> <p>M12 socket (A-coded)</p>	1	NC	Not used
	2	RS232-TX	Transmission line RS 232/service data
	3	GND	Voltage supply 0VDC
	4	RS232-RX	Receiving line RS 232/service data
	5	NC	Not used
	Thread	FE	Functional earth (housing)

Table 7.4: Service pin assignments

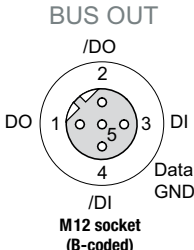

Notice!

The service interface is designed only for use by Leuze electronic!

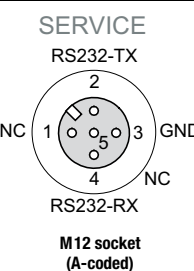
8 Display and control panel AMS 384i

8.1 Structure of the control panel

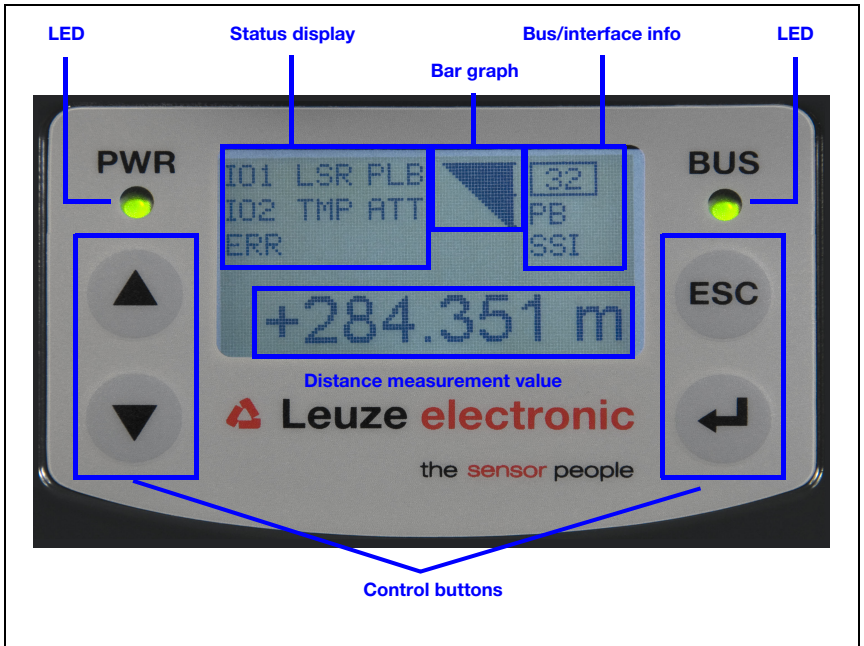

Figure 8.1: Structure of the control panel using the AMS 304i PROFIBUS device variant as an example



Notice!

The figure is for illustration purposes only and does not correspond to AMS 384i with respect to bus/interface info.

8.2 Status display and operation

8.2.1 Indicators in the display

Status and warning messages in the display

- IO1 **Input 1 or output 1 active:**
Function depending on configuration.
- IO2 **Input 2 or output 2 active:**
Function depending on configuration.

- LSR **Warning - laser prefailure message:**
Laser diode old, device still functional, exchange or have repaired.
- TMP **Warning - temperature monitoring:**
Permissible internal device temperature exceeded / not met.
- PLB **Plausibility error:**
Implausible measurement value. Possible causes: light beam interruption, outside of measurement range, permissible internal device temperature considerably exceeded or traverse rate >10m/s.

Depending on the configuration, either zero or the last valid measurement value is output at the interfaces.
- ATT **Warning received signal:**
Laser outlet window or reflector soiled or fogged by rain, water vapor or fog. Clean or dry surfaces.
- ERR **Internal hardware error:**
The device must be sent in for inspection.

Bar graph



Indicates the **strength of the received laser light**.
The center bar represents the **ATT** warning threshold. The distance value remains valid and is output at the interfaces.
If no bar graph is available, the **PLB** status information appears at the same time. The measurement value has thus been assessed as being implausible. Depending on the configuration, either zero or the last valid measurement value is output at the interfaces.

Interface info

The abbreviation "IBS" stands for the Interbus interface.

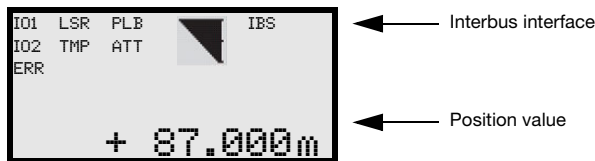

Position value

- The measured position value is displayed in the configured unit of measurement.
- +87.000m With the **metric** setting, the measurement value is always displayed in meters with **three decimal places**.
- +87.0in With the **inch** setting, the measurement value is always displayed in inches with **one decimal place**.

8.2.2 LED status displays

PWR LED

PWR



Off

Device OFF

- No supply voltage

PWR



Flashing green

Power LED flashes green

- No measurement value output
- Voltage connected
- Self test running
- Initialization running
- Parameter download running
- Boot process running

PWR



Green continuous light

Power LED green

- AMS 384*i* ok
- Measurement value output
- Self test successfully finished
- Device monitoring active

PWR



Red flashing

Power LED flashes red

- Device ok but warning message (ATT, TMP, LSR) set in display
- Light beam interruption
- Plausibility error (PLB)

PWR



Red continuous light

Power LED red

- No measurement value output; for details, see Display

PWR



Orange continuous light

Power LED orange

- Parameter enable active
- No data on the host interface

BUS LED

BUS



Flashing green

BUS LED flashes green

- Initialization of the AMS 384*i*
- AMS 348*i* not on the bus

BUS







Green continuous light

BUS LED green

- Data transmission ok

8.2.3 Control buttons

-  **Up** Navigate upward/laterally.
-  **Down** Navigate downward/laterally.
-  **ESC** Exit menu item.
-  **ENTER** Confirm/enter value, change menu levels.

Navigating within the menus

The menus within a level are selected with the up/down buttons  .

The selected menu item is activated with the enter button .





Press the ESC button  to move up one menu level.



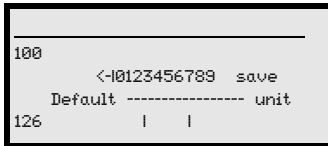

When one of the buttons is actuated, the display illumination is activated for 10min.



Setting values

If input of a value is possible, the display looks like this:



-  +  Delete character
-  +  Enter digit
- save** +  Save



Use the ,  and  buttons to set the desired value. An accidental, incorrect entry can be corrected by selecting <-l and then pressing .

Then use the ,  buttons to select **save** and save the set value by pressing .

Selecting options

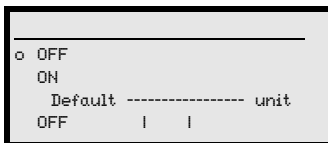
If options can be selected, the display looks like this:



Select the desired option with the ,  buttons. Activate the option by pressing .

8.3 Menu description

8.3.1 The main menus

After voltage has been applied to the laser, device information is displayed for several seconds. The display then shows the measurement window with all status information.

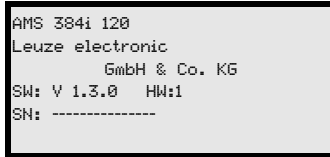

Device information - main menu

This menu item contains detailed information on

- device model,
- manufacturer,
- software and hardware version,
- serial number.

No entries can be made via the display.

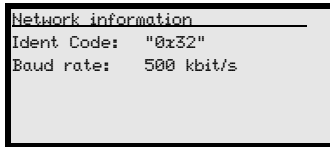

Network information - main menu

- Explanations of Ident code and baud rate.

No entries can be made via the display.

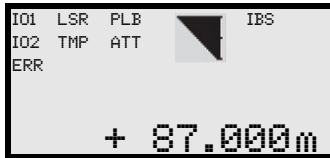

Status and measurement data - main menu

- Display of status-, warning-, and error messages.
- Status overview of the switching inputs/outputs.
- Bar graph for the reception level.
- Measurement value.

No entries can be made via the display.
See "Indicators in the display" on page 36.

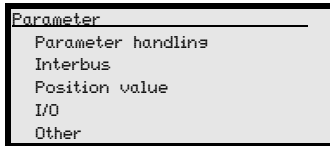

Parameter - main menu

- Configuration of the AMS.

See "Parameter menu" on page 41.



Language selection - main menu

- Selection of the display language.

See "Language selection menu" on page 44.

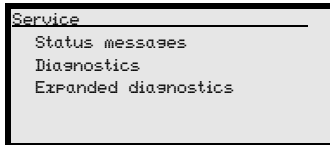

Service - main menu

- Display of status messages.
- Display of diagnostic data.

No entries can be made via the display.
See "Service menu" on page 45.



Notice!

The rear cover of this manual includes a **fold-out page** with the complete **menu structure**. It describes the menu items in brief.

8.3.2 Parameter menu

Parameter handling submenu

The following functions can be called up in the Parameter handling submenu:

- Lock and enable parameter entry
- Set up a password
- Reset the AMS 384i to default settings.

Table 8.1: Parameter handling submenu

Level 3	Level 4	Level 5	Selection/configuration option Description	Standard
Parameter enabling			ON / OFF The standard setting (OFF) prevents unintended parameter changes. With parameter enabling activated (ON), the display is inverted. In this state, it is possible to change parameters manually.	OFF
Password	Activate password		ON / OFF To enter a password, parameter enabling must be activated. If a password is assigned, changes to the AMS 384i can only be made after the password is entered. The master password 2301 bridges the individually set password.	OFF
	Password entry		Configuration option of a four-digit numerical password.	
Parameters to default			By pressing the enter button  after selecting Parameters to default, all parameters are reset to their standard settings without any further security prompts. In this case, English is selected as the display language.	

Additional important information on parameter handling can be found at the end of the chapter.

Interbus submenu

Table 8.2: Interbus submenu

Level 3	Level 4	Level 5	Selection/configuration option Description	Standard
Activation			ON / OFF Activates or deactivates the AMS 384 <i>i</i> as an Interbus participant.	ON
Baud rate			500kbit/s / 2000kbit/s Selection of the baud rate for serial communication. The baud rate specifies the speed of data transmission. It must be the same at the transmission and reception sides to enable communication.	500kbit/s
Coding			Gray / binary Specifies the output format of the measurement value.	Gray
Position resolution			0.1 mm / 1 mm / 10 mm / free resolution The measurement value can be displayed in these resolutions. The value of the free resolution is determined in the "Position value" submenu in the "Value of free resolution" parameter.	1 mm

Position value submenu

Table 8.3: Position value submenu

Level 3	Level 4	Level 5	Selection/configuration option Description	Standard
Measurement unit			Metric/Inch Specifies the units of the measured distances	Metric
Count direction			Positive/Negative Positive: The measurement value begins at 0 and increases with increasing distance. Negative: The measurement value begins at 0 and decreases with increasing distance. Negative distance values may need to be compensated with an offset or preset.	Positive
Offset			Output value=measurement value+offset. The resolution of the offset value is independent of the selected "Resolution position" and is entered in mm or inch/100. The offset value is effective immediately following entry. If the preset value is activated, this has priority over the offset. Preset and offset are not offset against each other.	0mm
Preset			The preset value is accepted by means of teach pulse. The teach pulse can be applied to a hardware input of the M12 PWR connector. The hardware input must be appropriately configured. See also configuration of the I/Os.	0mm
Free resolution value			The measurement value can be resolved in increments of 1/1000 within the 5 ... 50000 value range. If, e.g., a resolution of 0.875mm per digit is required, the parameter is set to 875.	1000
Error delay			ON / OFF Specifies whether, in the event of an error, the position value immediately outputs the value of the "Position value in the case of error" parameter or the last valid position value for the configured error delay time.	ON/100 ms
Position value in the case of error			Last valid value / zero Specifies which position value is output after the error delay time elapses.	Null

I/O submenu

Table 8.4: I/O submenu

Level 3	Level 4	Level 5	Selection/configuration option Description	Standard
I/O 1	Port configuration		Input/Output Defines whether I/O 1 functions as an output or input.	Output
	Switching input	Function	No function/preset teach/laser ON/OFF Input LOW = laser ON, HIGH = laser OFF	Laser ON/OFF
		Activation	Low active/High active	Low active
	Switching output	Function		No function
Activation		Low active/High active	Low active	
I/O 2	Port configuration		Input/Output Defines whether I/O 2 functions as an output or input.	Output
	Switching input	Function		No function
		Activation	Low active/High active	Low active
	Switching output	Function	Output = High, if the travel speed is faster than 0.2m/s	Velocity monitoring
Activation		Low active/High active	Low active	
Limit values	Upper pos. limit 1	Activation	ON / OFF	OFF
		Limit value input	Value input in mm or inch/100	0
	Lower pos. limit 1	Activation	ON / OFF	OFF
		Limit value input	Value input in mm or inch/100	0
	Upper pos. limit 2	Activation	ON / OFF	OFF
		Limit value input	Value input in mm or inch/100	0
Lower pos. limit 2	Activation	ON / OFF	OFF	
	Limit value input	Value input in mm or inch/100	0	

Other submenu

Table 8.5: Other submenu

Level 3	Level 4	Level 5	Selection/configuration option Description	Standard
Heating control			Standard (10°C ... 15°C)/Extended (30°C ... 35°) Defines a switch-on/switch-off range for the heating control. The extended switch-on/switch-off range for heating may provide relief in the event of condensation problems. There is no guarantee that no condensation will occur on the optics in the extended switch-on/switch-off range due to the limited heating capacity. This parameter is available as standard, but functions only for devices with integrated heating (AMS 384i... H).	Standard
Display illumination			10 minutes/ON Display illumination is switched off after 10 minutes or, if the parameter is set to "ON", illumination is always on.	10 min.
Display contrast			Weak/Medium/Strong The display contrast may change at extreme temperature values. The contrast can subsequently be adapted using the three levels.	Medium
Service RS232	Baud rate		57.6kbit/s / 115.2kbit/s The service interface is only available to Leuze internally.	115.2kbit/s
	Format		8,e,1 / 8,n,1 The service interface is only available to Leuze internally.	8,n,1

8.3.3 Language selection menu

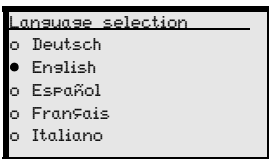

There are 5 display languages available:

- German
- English
- Spanish
- French
- Italian

The AMS 384i is delivered from the factory with the display preset to English.

To change the language, no password needs to be entered nor must password enabling be activated. The display language is a passive operational control and is, thus, not a function parameter, per se.

8.3.4 Service menu

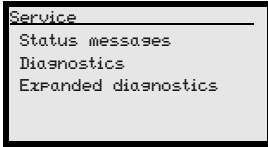

A more detailed description of the individual functions can be found in chapter 10.

8.4 Operation



Described here is an operating process using parameter enabling as an example.

Parameter enabling

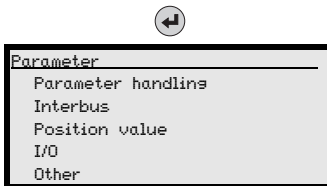
During normal operation parameters can only be viewed. If parameters are to be changed, the ON menu item in the Parameter -> Parameter handling -> Parameter enable menu must be activated. To do this, proceed as follows:



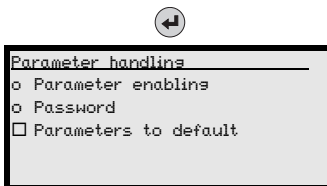

In the main menu, press the enter button to enter the Parameter menu.

Use the   buttons to select the Parameter handling menu item.



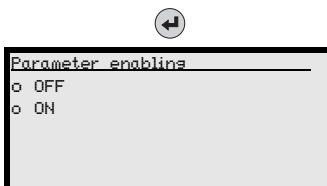

Press the enter button to enter the Parameter handling menu.

In the Parameter handling menu, use the   buttons to select the Parameter enabling menu item.



Press the enter button to enter the Parameter enabling menu.

In the Parameter enabling menu, use the   buttons to select the ON menu item.

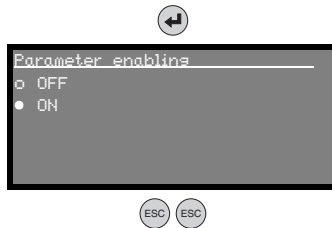

Press the enter button to switch on parameter enabling.

The PWR LED illuminates orange; the display is inverted. You can now set the individual parameters on the display.

Press the ESC button twice to return to the Parameter menu.



Viewing and editing parameters

As long as parameter enabling is activated, the entire AMS 384*i* display is inverted.



Notice!

Changes to parameters via display entry have immediate effect.

If a password was stored, parameter enabling is not possible until this password is entered, see "Password for parameter enabling" below.

Password for parameter enabling

Parameter entry on the AMS 384*i* can be protected with a four-digit numerical password. With the AMS 384*i*, the password is entered via the display. If parameter enabling has been activated after successfully entering the password, parameters can be changed via the display.



Notice!

*The **master password 2301** can enable the AMS 384*i* at any time.*

9 Interbus interface

9.1 General information on Interbus

The AMS 384*i* is designed as an Interbus device.

The data output format of the AMS 384*i* is defined via default settings. The baud rate of the data to be transferred is 500kbit/s in the standard setting and can be configured to 2 Mbit/s.



Notice!

The Interbus interface can be activated/deactivated via the display. With the Interbus activated, the IBS abbreviation is shown on the display.

9.2 Interbus electrical connection

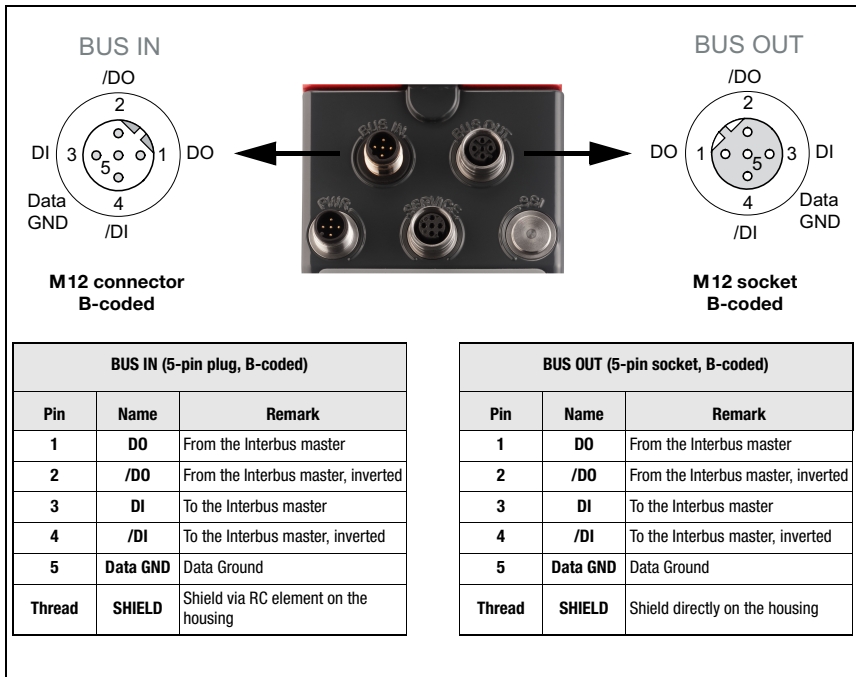

Figure 9.1: Interbus - Electrical connection



Notice!

For contacting **BUS IN** and **BUS OUT**, we recommend our ready-made Interbus cable (see chapter 11.4.5 "Accessory ready-made cables for Interbus").



Attention!

The laser measurement system can be used to branch out the Interbus network.

The **continuing network** is connected via **BUS OUT**.

The integrated **SUPI** (Serial Universal Peripheral Interface) automatically detects whether additional participants are connected to **BUS OUT**. Termination of **BUS OUT** is not necessary.

9.3 Interbus shielding and grounding concept

The cable shielding must be concentric and have the largest possible surface area on the M12 connector (thread).

The M12 thread for **BUS IN** is connected to the functional earth (FE) inside the AMS 384*i* via an RC element (1MΩ || 15nF). The M12 thread for **BUS OUT** is conductively connected to the housing and is thus directly connected to the functional earth (FE).

9.3.1 Interbus - voltage supply electrical connection

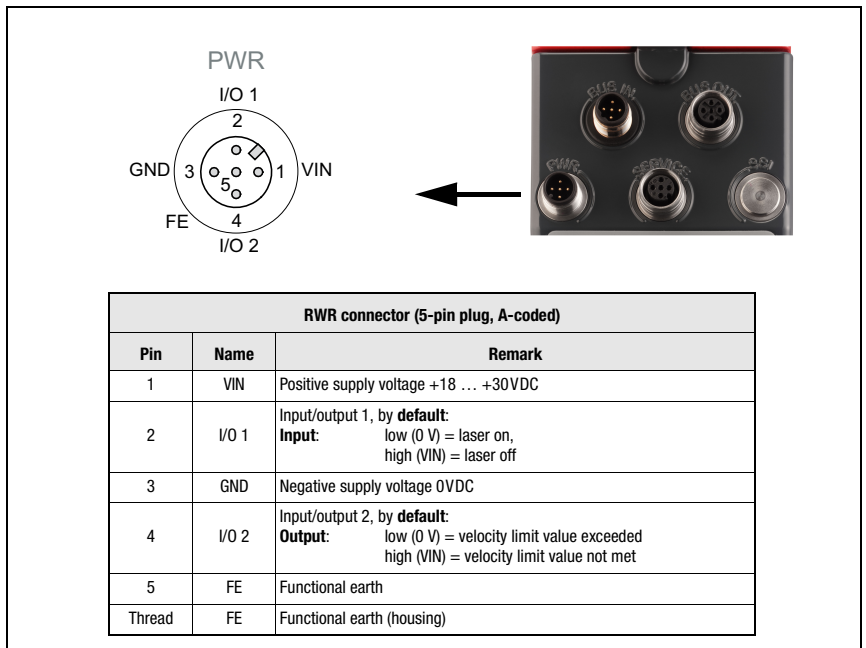

Figure 9.2: Interbus - voltage supply



Notice!

Input I/O 1 (pin 2) - laser ON/OFF:

If the laser diode of the AMS 384*i* is deactivated, the data double word A0 00 00 00_H is transferred. In this case, bit 31 is permanently set to logic **1** and message "PLB" is transferred, see chapter 9.5 "Interbus data format - 32-bit input data".

9.4 Interbus Ident number of the AMS 384*i*

The AMS 384*i* is classified with Interbus **Ident code 32_H**. The classification describes the AMS 384*i* as a remote bus participant with 32-bit input data.

9.5 Interbus data format - 32-bit input data

byte 0								byte 1								byte 2								byte 3																			
7	6	5	4	3	2	1	0	7	6	5	4	3	2	1	0	7	6	5	4	3	2	1	0	7	6	5	4	3	2	1	0												
"1" level	ERR	PLB	ATT	LSR	TMP	Reserved	Reserved	MSB measurement value	Measurement value, Gray coded, resolution 1 mm																												LSB measurement value						
	Sign																											Sign															
3	2	1	0	9	8	7	6	2	1	0	9	8	7	6	2	1	0	9	8	7	6	2	1	0	9	8	7	6	5	4	3	2	1	0									
MSB																																				LSB							

Table 9.1: Interbus data format - 32-bit input data

 The AMS 384*i* makes available 32-bit input data. The breakdown of the 32 bits is shown in the above table.

The data format in detail:



Notice!

Resolution and maximum position value which can be represented:

IBS setting	Max. distance which can be represented Metric (m)	Max. distance which can be represented Inches (in)	
23-bit; resolution 1 mm	8,388m	8,3886in	≈ 21,307m
23-bit; resolution 0.1 mm	838m	8,388in	≈ 2,131m
23-bit; resolution 0.01 mm	83,8m	838in	≈ 213m

Table 9.2: Resolution and maximum position value which can be represented:

Bit 0 ... Bit 22	<p>Measurement value: Representation of the measured distance, Gray coded with a resolution of 1 mm. The coding of the measurement value can be switched from Gray (default) to binary. The setting can be found in the Parameter -> Interbus -> Coding menu.</p>
Bit 23	<p>Sign of the measured distance: 0 = positive distance value 1 = negative distance value (e.g. through the use of the offset function)</p>
Bit 24 ... Bit 25	Reserved, statically set to binary 0
Bit 26	<p>TMP - Temperature monitoring warning. Above/below permissible internal device temperature.</p>
Bit 27	<p>LSR - Warning laser prefailure message. Laser diode aged, device still functional, please initiate replacement or repair.</p>
Bit 28	<p>ATT - Received signal warning. Laser emission window or reflector dirty.</p>
Bit 29	<p>PLB - Plausibility error. Implausible measurement value. Possible causes: Light beam interruption Measurement range exceeded Internal device temperature considerably above/below limit Traverse rate >10m/s.</p>
Bit 30	<p>ERR - Internal hardware error. The device must be sent in for inspection.</p>
Bit 31	Static always 1 , even in the Gray coding.



Notice!

The AMS 384i makes a new 32-bit long data set available every 1.7ms. Depending on the number of configured participants and the quantity of data to be transferred by the participants, the baud rate of 500kbit/s or 2Mbit/s can result in the same data set of the AMS 384i being read multiple times in succession.

*With the Interbus deactivated (Interbus **OFF** via control panel/display), bit 31 remains statically set to binary **1**. Bit 30 ... bit 0 are statically set to binary **0**.*

A deactivated AMS 384i can be recognized on the process data monitor of the Interbus master by means of the data double word 80 00 00 00_H.

Continuing participants connected via Bus OUT are also addressed when the Interbus is deactivated.

9.5.1 Default settings of the Interbus interface

Default parameters of the AMS 384 <i>i</i> xxx (H)	
Interbus activation ¹⁾	ON
Baud rate	500kbit/s
Ident code	32H
Number of data bits	32
Data breakdown	23-bit measurement value, 1-bit sign, 2-bit reserved, 3-bit pre-failure messages, 2-bit errors, 1-bit statically set to binary 1
Measurement value display ¹⁾	Gray
Unit ¹⁾	Metric
Resolution ¹⁾	1mm
Count direction ¹⁾	Positive
I/O 1 ¹⁾	Input LOW = laser on, HIGH = laser off
I/O 2 ¹⁾	Velocity monitoring output set to > 0.2m/s (configurable)
Static preset ¹⁾	+ 000.000
Dynamic preset ¹⁾	+ 000.000
Pos. limit value range 1 ¹⁾	Lower and upper limit, both 000.000
Pos. limit value range 2 ¹⁾	Lower and upper limit, both 000.000
Error handling procedures ¹⁾	Position output: 000.000 Position status suppression: active Error delay time: 100ms
Display language ¹⁾	English
Display illumination ¹⁾	Off after 10min.
Display contrast ¹⁾	Medium
Password protection ¹⁾	Off
Password ¹⁾	0000

1) Parameter can be changed via the control panel/display

Table 9.3: Default settings of the Interbus interface



Notice!

The AMS 384*i* cannot be configured via the Interbus.

*The settings labeled with footnote 1) can be changed via the display. Changed parameters are stored in the AMS 384*i* and are reactivated following power off/on.*



10 Diagnostics and troubleshooting

10.1 Service and diagnostics in the display of the AMS 384*i*

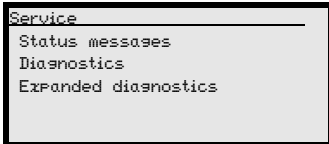
In the main menu of the AMS 384*i*, expanded "Diagnostics" can be called up under the Service heading.



From the Service main menu, press the enter button  to access the underlying menu level.



Use the up/down buttons   to select the corresponding menu item in the selected level; use the enter button  to activate the selection.

Return from any sublevel to the next-higher menu item by pressing the ESC button .

10.1.1 Status messages

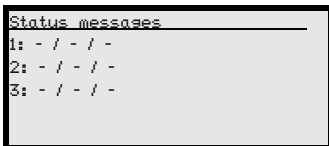
The status messages are written in a ring memory with 25 positions. The ring memory is organized according to the FIFO principle. No separate activation is necessary for storing the status messages. Power OFF clears the ring memory.



The status messages within the ring memory are selected with the up/down buttons  . Use the enter button  to call up detailed information about the respective status message that includes the following details:



- Type:** Designates the message type **I** = info; **W** = warning, **E** = error.
- No:** Internal numbering
- Ref.:** Plain-text explanation of the displayed status
- Time:** Time stamp in the hh.mm format. The displayed time is added to the time since the last power ON. Power OFF clears the time stamp.

10.1.2 Diagnostics

The diagnostics function is activated by selecting the `Diagnostics` menu item. The ESC button  deactivates the diagnostics function and clears the contents of the recordings.

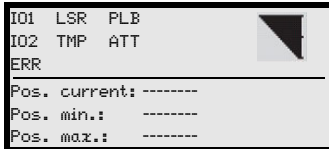
The recorded diagnostic data are displayed in 2 fields. In the upper half of the display, status messages of the AMS and the bar graph are displayed. The lower half contains information that assists in a Leuze-internal evaluation.



Use the up/down buttons   to scroll in the bottom half between various displays. The contents of the scrollable pages are intended solely for Leuze for internal evaluation.

The diagnostics have no influence on the communication to the host interface and can be activated during operation of the AMS 384*i*.

10.1.3 Expanded diagnostics

The `Expanded diagnostics` menu item is used for Leuze-internal evaluation.

10.2 General causes of errors

10.2.1 Power LED

See also chapter 8.2.2.

Error	Possible error cause	Measure
PWR LED "OFF"	No supply voltage connected	Check supply voltage.
	Hardware error	Send in device.
PWR-LED "flashes red"	Light beam interruption	Check alignment.
	Plausibility error	Traverse rate >10m/s.
PWR-LED "static red"	Hardware error	For error description, see display, It may be necessary to send in the device.

Table 10.1: General causes of errors

10.3 Interface errors

10.3.1 BUS LED

The LED does not show a bus failure with the AMS 384*i*.

10.4 Status display in the display of the AMS 384*i*

Display	Possible error cause	Measure
PLB (implausible measurement values)	Laser beam interruption	Laser spot must always be incident on the reflector.
	Laser spot outside of reflector	Traverse rate < 10 m/s?
	Measurement range for maximum distance exceeded	Restrict traversing path or select AMS with larger measurement range.
	Velocity greater than 10 m/s	Reduce velocity.
ATT (insufficient received signal level)	Ambient temperature far outside of the permissible range (TMP display; PLB)	Select AMS with heating or ensure cooling.
	Reflector soiled	Clean reflector or glass lens.
	Glass lens of the AMS soiled	
	Performance reduction due to snow, rain, fog, condensing vapor, or heavily polluted air (oil mist, dust)	Optimize usage conditions.
TMP (operating temperature outside of specification)	Laser spot only partially on the reflector	Check alignment.
	Protective foil on the reflector	Remove protective foil from reflector.
LSR laser diode warning	Ambient temperatures outside of the specified range	In case of low temperatures, remedy may be an AMS with heating. If temperatures are too high, provide cooling or change mounting location.
ERR Hardware error.	Laser diode prefailure message	Send in device at next possible opportunity to have laser diode replaced. Have replacement device ready.
	Indicates an uncorrectable error in the hardware	Send in device for repair.



Notice!

Please use **chapter 10 as a master copy** should servicing be required.
 Cross the items in the "Measures" column which you have already examined, fill out the following address field and fax the pages together with your service contract to the fax number listed below.

Customer data (please complete)

Device type:	
Company:	
Contact partner / department:	
Phone (direct):	
Fax:	
Street / No:	
ZIP code/City:	
Country:	

Leuze Service fax number:
+49 7021 573 - 199

11 Type overview and accessories

11.1 Type key

AMS 3xx i **yyy** H

Heating option	H =	With heating
Sensing distance	40	Max. operating range in m
	120	Max. operating range in m
	200	Max. operating range in m
	300	Max. operating range in m
	i =	Integrated fieldbus technology
Interface	00	RS 422/RS 232
	01	RS 485
	04	PROFIBUS DP / SSI
	08	TCP/IP
	35	CANopen
	38	EtherCAT
	48	PROFINET RT
	55	DeviceNet
	58	EtherNet/IP
	84	Interbus

AMS Absolute Measuring System

11.2 Type overview AMS 384*i* (Interbus)

Type designation	Description	Part No.
AMS 384 <i>i</i> 40	40m operating range, Interbus interface	50113733
AMS 384 <i>i</i> 120	120m operating range, Interbus interface	50113734
AMS 384 <i>i</i> 200	200m operating range, Interbus interface	50113735
AMS 384 <i>i</i> 300	300m Reichweite, Interbus Schnittstelle	50113736
AMS 384 <i>i</i> 40 H	40m operating range, Interbus interface, integrated heating	50113737
AMS 384 <i>i</i> 120 H	120m operating range, Interbus interface, integrated heating	50113738
AMS 384 <i>i</i> 200 H	200m operating range, Interbus interface, integrated heating	50113739
AMS 384 <i>i</i> 300 H	300m operating range, Interbus interface, integrated heating	50113740

Table 11.1: Type overview AMS 384*i*

11.3 Overview of reflector types

Type designation	Description	Part No.
Reflective tape 200x200-S	200x200mm, reflective tape, self-adhesive	50104361
Reflective tape 500x500-S	500x500mm, reflective tape, self-adhesive	50104362
Reflective tape 914x914-S	914x914mm, reflective tape, self-adhesive	50108988
Reflective tape 200x200-M	Reflective tape, 200x200mm, affixed to aluminum plate	50104364
Reflective tape 500x500-M	Reflective tape, 500x500mm, affixed to aluminum plate	50104365
Reflective tape 914x914-M	Reflective tape, 914x914mm, affixed to aluminum plate	50104366
Reflective tape 200x200-H	Heated reflective tape, 200 x 200mm	50115020
Reflective tape 500x500-H	Heated reflective tape, 500 x 500mm	50115021
Reflective tape 914x914-H	Heated reflective tape, 914 x 914mm	50115022

Table 11.2: Overview of reflector types

11.4 Accessories

11.4.1 Accessory mounting bracket

Type designation	Description	Part No.
MW OMS/AMS 01	Mounting bracket for mounting the AMS 384 <i>i</i> to horizontal surfaces	50107255

Table 11.3: Accessory mounting bracket

11.4.2 Accessory deflector unit

Type designation	Description	Part No.
US AMS 01	Deflector unit with integrated mounting bracket for the AMS 384 <i>i</i> . Variable 90° deflection of the laser beam in various directions	50104479
US 1 OMS	Deflector unit without mounting bracket for simple 90° deflection of the laser beam	50035630

Table 11.4: Accessory deflector unit

11.4.3 Accessory M12 connector

Type designation	Description	Part No.
KD 02-5-BA	M12 connector, B-coded socket, BUS IN	50038538
KD 02-5-SA	M12 connector, B-coded plug, BUS OUT	50038537
KD 095-5A	M12 connector, A-coded socket, Power (PWR)	50020501

Table 11.5: Accessory M12 connector

11.4.4 Accessory ready-made cables for voltage supply

Contact assignment/wire color of PWR connection cable

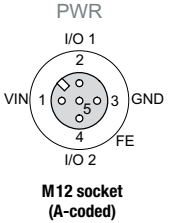
PWR connection cable (5-pin socket, A-coded)			
 <p>PWR I/O 1 2 VIN 1 3 GND 4 I/O 2 FE M12 socket (A-coded)</p>	Pin	Name	Core color
	1	VIN	brown
	2	I/O 1	white
	3	GND	blue
	4	I/O 2	black
	5	FE	grey
	Thread	FE	bare

Specifications of the cables for voltage supply

Operating temperature range in rest state: -30°C ... +70°C
in motion: -5°C ... +70°C

Material sheathing: PVC

Bending radius > 50mm

Order codes of the cables for voltage supply

Type designation	Description	Part No.
K-D M12A-5P-5m-PVC	M12 socket, A-coded, axial plug outlet, open cable end, cable length 5 m	50104557
K-D M12A-5P-10m-PVC	M12 socket, A-coded, axial plug outlet, open cable end, cable length 10 m	50104559

11.4.5 Accessory ready-made cables for Interbus

General

- KB SSI/IBS... cable for connecting to the BUS IN
- KB IBS... cable for connecting to the BUS OUT
- Standard cables available in lengths from 2 ... 30m
- Special cables on request

Contact assignments of Interbus connection cable

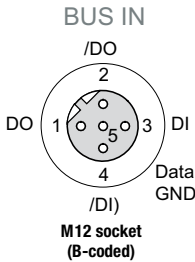
SSI/IBS connection cable (5-pin socket, B-coded) for BUS IN			
 <p>M12 socket (B-coded)</p>	Pin	Name	Core color
	1	DO	yellow
	2	/DO	green
	3	DI	grey
	4	/DI	pink
	5	Data Ground	brown
Thread	FE	shield on the housing	

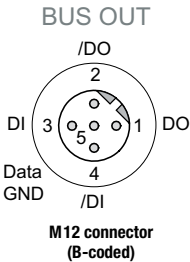
IBS connection cable (5-pin connector, B-coded) for BUS OUT			
 <p>M12 connector (B-coded)</p>	Pin	Name	Core color
	1	DO	yellow
	2	/DO	green
	3	DI	grey
	4	/DI	pink
	5	Data Ground	brown
Thread	FE	shield on the housing	

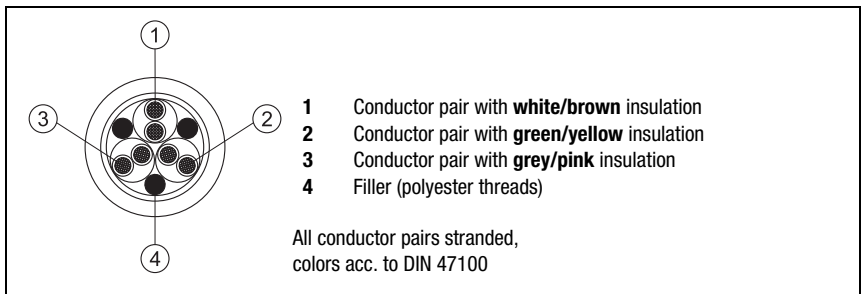

Interbus specifications

Operating temperature range in rest state: -40°C ... +80°C
 in motion: -5°C ... +80°C

Material the cables fulfill the Interbus requirements
 free of halogens, silicone and PVC

Bending radius > 80mm, suitable for drag chains

Order codes Interbus BUS IN connection cable

Type designation	Description	Part No.
KB SSI/IBS-2000-BA	M12 socket, B-coded, for SSI/Interbus, axial connector, open cable end, cable length 2m	50104172
KB SSI/IBS-5000-BA	M12 socket, B-coded, for SSI/Interbus, axial connector, open cable end, cable length 5m	50104171
KB SSI/IBS-10000-BA	M12 socket, B-coded, for SSI/Interbus, axial connector, open cable end, cable length 10m	50104170
KB SSI/IBS-15000-BA	M12 socket, B-coded, for SSI/Interbus, axial connector, open cable end, cable length 15m	50104169
KB SSI/IBS-20000-BA	M12 socket, B-coded, for SSI/Interbus, axial connector, open cable end, cable length 20m	50104168
KB SSI/IBS-25000-BA	M12 socket, B-coded, for SSI/Interbus, axial connector, open cable end, cable length 25m	50108447
KB SSI/IBS-30000-BA	M12 socket, B-coded, for SSI/Interbus, axial connector, open cable end, cable length 30m	50108446

Order codes Interbus BUS OUT connection cable

Type designation	Remark	Part No.
KB IBS-2000-SA	M12 connector, B-coded, for Interbus, axial connector, open cable end, cable length 2m	50108595
KB IBS-5000-SA	M12 connector, B-coded, for Interbus, axial connector, open cable end, cable length 5m	50108596
KB IBS-10000-SA	M12 connector, B-coded, for Interbus, axial connector, open cable end, cable length 10m	50108597
KB IBS-15000-SA	M12 connector, B-coded, for Interbus, axial connector, open cable end, cable length 15m	50108598
KB IBS-20000-SA	M12 connector, B-coded, for Interbus, axial connector, open cable end, cable length 20m	50108599
KB IBS-25000-SA	M12 connector, B-coded, for Interbus, axial connector, open cable end, cable length 25m	50108600
KB IBS-30000-SA	M12 connector, B-coded, for Interbus, axial connector, open cable end, cable length 30m	50108601

12 Maintenance

12.1 General maintenance information

With normal use, the laser measurement system does not require any maintenance by the operator.

Cleaning

In the event of dust build-up or if the (ATT) warning message is displayed, clean the device with a soft cloth; use a cleaning agent (commercially available glass cleaner) if necessary. Also check the reflector for possible soiling.



Attention!

Do not use solvents and cleaning agents containing acetone. Use of such solvents could blur the reflector, the housing window and the display.

12.2 Repairs, servicing



Attention!

Access to or changes on the device, except where expressly described in this operating manual, are not authorized.

The device must not be opened. Failure to comply will render the guarantee void. Warranted features cannot be guaranteed after the device has been opened.

Repairs to the device must only be carried out by the manufacturer.

Contact your Leuze distributor or service organization should repairs be required. The addresses can be found on the inside of the cover and on the back.



Notice!

When sending the laser measurement systems to Leuze electronic for repair, please provide an accurate description of the error.

12.3 Disassembling, packing, disposing

Repacking

For later reuse, the device is to be packed so that it is protected.

Note!

Electrical scrap is a special waste product! Observe the locally applicable regulations regarding disposal of the product.

A	
Accessories	55
Accessory deflector unit	56
Accessory mounting bracket	56
Accessory ready-made cables	57
Accuracy	11
Air humidity	12
Alignment	17
Areas of application	6
B	
BUS LED	38
C	
CDRH	7
Cleaning	60
Connections	
Interbus BUS IN	34
Interbus BUS OUT	35
PWR IN	34
Service	35
Control buttons	39
Control panel	36
D	
Declaration of conformity	4
Deflector unit	
Maximum ranges	20
with integrated mounting bracket	20
without mounting bracket	22
Deflector unit US 1 OMS	
Dimensioned drawing	22
Deflector unit US AMS 01	
Dimensioned drawing	21
Description of functions	5
Diagnostics	52
Dimensioned drawing of AMS 3xxi	13
Display	36
Distance to an adjacent DDLs 200	19
E	
Electrical connection	33
Safety notices	33
Expanded diagnostics	53
Explanation of symbols	4
G	
General causes of errors	53
H	
Hazard warning & logotype	8
Heated reflectors	
Dimensioned drawing	27
Specifications	26
I	
Installation	15
Intended use	6
Interbus	
Default settings	51
Interbus data format	49
Interbus Ident number	49
Interbus interface	47
Default settings	51
Interbus shield/grounding concept	48
Interface errors	53
Interface info in display	37
Internal hardware error	37
L	
Laser class	7
Laser radiation	7
LSR status display	54
M	
Main menu	
Device information	40
Language selection	40
Network information	40
Parameter	40
Service	40
Status- and measurement data	40
Maintenance	60
Maximum position value	
which can be represented	49
Measurement range	11
Measurement value output	11
Menus	
Language selection menu	44
Main menu	40
Parameter menu	41
Service menu	44

Mounting 16
 with laser beam deflector unit 20
 Mounting bracket(optional) 18
 Mounting distances 19

N

Name plate 8
 Name plates 15

O

Operating temperature 12
 Operation 36, 45
 Overview of reflector types 56

P

Packaging 15
 Parallel spacing between adjacent AMS 3xxi . 19
 Parameter enabling 45, 46
 Parameter menu
 I/O 42
 Interbus 41
 Other 43
 Parameter handling 41
 Position value 42
 Plausibility error. 37
 Prefailure message 37
 PWR LED 38

Q

Quality assurance 4

R

Received signal 37
 Reflective tape
 Dimensioned drawing 25
 Specifications 24
 Reflector 23
 Mounting 29
 Pitch 32
 Size 28
 Type overview 28
 Repair 6, 60

S

Safety notices 6
 Sensing distance 55
 Servicing 60
 Specifications 11
 Dimensioned drawing 13
 General specifications 11
 Reflective tapes 23
 Status- and warning messages 36
 Status display 36
 ATT 54
 ERR 54
 PLB 54
 TMP 54
 Status display in the display 54
 Status Displays 38
 Status messages 52
 Storage 15
 Storage temperature 12
 Supply voltage 11
 Surface reflections 30
 Symbols 4

T

Temperature monitoring 37
 Termination 48
 Transport 15
 Troubleshooting 52
 Type overview 14, 55

Level 1	Level 2	Level 3	Level 4	Level 5	Selection/configuration option	Detailed information on	
▲▼ : selection	▲▼ : selection ESC : back	▲▼ : selection ESC : back	▲▼ : selection ESC : back	▲▼ : selection ESC : back	▲▼ : selection ↔ : activate ESC : back		
Device information						page 40	
Network information						page 40	
Status- and measurement data						page 40	
Parameter	↔ Parameter handling	↔ Parameter enabling			ON / OFF	page 41	
		↔ Password	↔ Activate password		ON / OFF		
			↔ Password entry		Configuration option of a four-digit numerical password		
		↔ Parameters to default		All parameters are reset to their factory settings			
↔ Interbus	↔ Activation				ON / OFF	page 42	
	↔ Baud rate				500 kbit/s / 2000 kbit/s		
	↔ Coding				Gray / binary		
	↔ Position resolution				0.1 mm / 1 mm / 10 mm / free resolution		
↔ Position value	↔ Measurement unit				Metric/Inch	page 42	
	↔ Count direction				Positive/Negative		
	↔ Offset				Value input		
	↔ Preset				Value input		
	↔ Error delay				ON / OFF		
	↔ Position value in the case of error				Last valid value / zero		
	↔ Free resolution value				5 ... 50000		
↔ I/O	↔ I/O 1	↔ Port configuration			Input/Output	page 43	
		↔ Switching input	↔ Function		Laser ON/OFF		
			↔ Activation		Low active/High active		
		↔ Switching output	↔ Function		No function		
			↔ Activation		Low active/High active		
	↔ I/O 2	↔ Port configuration					Input/Output
		↔ Switching input	↔ Function		No function		
			↔ Activation		Low active/High active		
		↔ Switching output	↔ Function		Velocity monitoring		
			↔ Activation		Low active/High active		
	↔ Limit values	↔ Upper pos. limit 1	↔ Activation		ON / OFF		
			↔ Limit value input		Value input in mm or inch/100		
		↔ Lower pos. limit 1	↔ Activation		ON / OFF		
			↔ Limit value input		Value input in mm or inch/100		
↔ Upper pos. limit 2		↔ Activation		ON / OFF			
		↔ Limit value input		Value input in mm or inch/100			
	↔ Lower pos. limit 2	↔ Activation		ON / OFF			
		↔ Limit value input		Value input in mm or inch/100			

	Other	Heating control		Standard/extended (10°C ... 15°C/30°C ... 35°C)	page 44
		Display background		10 minutes/ON	
		Display contrast		Weak/Medium/Strong	
		Service RS232	Baud rate	57.6kbit/s / 115.2kbit/s	
			Format	8,e,1 / 8,n,1	
Language selection			Deutsch / English / Español / Français / Italiano	page 44	
Service	Status messages		Number of readings, reading gates, reading rate / non-reading rate etc.	page 45	
	Diagnostics		Exclusively for service purposes by Leuze electronic		
	Expanded diagnostics		Exclusively for service purposes by Leuze electronic		