



Optical Distance Sensors ODSL 30

Technical description / Software description





Leuze electronic GmbH + Co. KG
 P.O. Box 1 111, D-73277 Owen/Teck
 Tel. +49(0)7021/573-0,
 Fax +49(0)7021/573-199
 E-mail: info@leuze.de, www.leuze.de

Sales and Service

Sales Region North
 Phone 07021/573-306
 Fax 07021/9850950

Postal code areas
 20000-38999
 40000-53999
 54000-55999
 56000-65999
 97000-97999



Sales Region East
 Phone 035027/629-106
 Fax 035027/629-107

Postal code areas
 01000-19999
 39000-39999
 98000-99999

Sales Region South
 Phone 07021/573-307
 Fax 07021/9850911

Postal code areas
 66000-96999

Worldwide

AR (Argentina)
 Nortónica S. R. L.
 Tel. Int. + 54 (0) 11/4757-3129
 Fax Int. + 54 (0) 11/4757-1088

AT (Austria)
 Ing. Franz Schmachtl KG
 Tel. Int. + 43 (0) 732/7646-0
 Fax Int. + 43 (0) 732/765036

AU + NZ (Australia + New Zealand)
 Balluff-Leuze Pty. Ltd.
 Tel. Int. + 61 (0) 3/97204100
 Fax Int. + 61 (0) 3/97382677

BE (Belgium)
 Leuze electronic nv/sa
 Tel. Int. + 32 (0) 2/2531600
 Fax Int. + 32 (0) 2/2531536

BR (Brasil)
 Leuze electronic Ltda.
 Tel. Int. + 55 (0) 11/4195-6134
 Fax Int. + 55 (0) 11/4195-6177

CH (Switzerland)
 Leuze electronic AG
 Tel. Int. + 41 (0) 44/8340204
 Fax Int. + 41 (0) 44/8332626

CL (Chile)
 Imp. Tec. Vignola S.A.I.C.
 Tel. Int. + 56 (0) 32/351111
 Fax Int. + 56 (0) 32/351128

CN (China)
 Leuze electronic Trading
 (Shenzhen) Co. Ltd.
 Tel. Int. + 86 (0)755/86264909
 Fax Int. + 86 (0)755/86264901

CO (Colombia)
 Componentes Electronicas Ltda.
 Tel. Int. + 57 (0) 43 511049
 Fax Int. + 57 (0) 43 511019

CZ (Czech Republic)
 Schmachtl CZ s.r.o.
 Tel. Int. + 420 (0) 2/44001500
 Fax Int. + 420 (0) 2/44910700

DK (Denmark)
 Desim Elektronik APS
 Tel. Int. + 45/70220086
 Fax Int. + 45/70222220

ES (Spain)
 Leuze electronic S.A.
 Tel. Int. + 34 93/4097900
 Fax Int. + 34 93/4905820

FI (Finland)
 SKS-automaatio Oy
 Tel. Int. + 358 (0) 9/852661
 Fax Int. + 358 (0) 9/8526820

FR (France)
 Leuze electronic sarl.
 Tel. Int. + 33 (0) 1/60051220
 Fax Int. + 33 (0) 1/60050365

GB (United Kingdom)
 Leuze Mayer electronic Ltd.
 Tel. Int. + 44 (0) 14 80/408500
 Fax Int. + 44 (0) 14 80/403808

GR (Greece)
 UTECO A.B.E.E.
 Tel. Int. + 30 (0) 211/120690
 Fax Int. + 30 (0) 211/120699

HK (Hong Kong)
 Sensortech Company
 Tel. Int. + 852/26510188
 Fax Int. + 852/26510388

HU (Hungary)
 Kvalix Automatika Kft.
 Tel. Int. + 9 72 (0) 1/272242
 Fax Int. + 36 (0) 1/272244

IL (Israel)
 Galoz electronics Ltd.
 Tel. Int. + 9 72 (0) 3/9023456
 Fax Int. + 9 72 (0) 3/9021990

IN (India)
 Global Tech (India) Pvt. Ltd.
 Tel. Int. + 91 (0) 20/24470085
 Fax Int. + 91 (0) 20/24470086

IR (Iran)
 Tavari Rissan Co. Ltd.
 Tel. Int. + 98 (0) 21/2606766
 Fax Int. + 98 (0) 21/2002883

IT (Italy)
 Leuze electronic S.r.l.
 Tel. Int. + 39 02/26110643
 Fax Int. + 39 02/26110640

JP (Japan)
 C. Illies & Co., Ltd.
 Tel. Int. + 81 (0) 3/34434111
 Fax Int. + 81 (0) 3/34434118

KR (South Korea)
 Leuze electronic Co. Ltd.
 Tel. Int. + 82 (0) 31/3828228
 Fax Int. + 82 (0) 31/3828522

MX (Mexico)
 Leuze Lumiflex México, S.A. de C.V.
 Tel. Int. + 52 (0) 81/83 71 88 15
 Fax Int. + 52 (0) 81/83 71 85 88

MY (Malaysia)
 Ingermark (M) SDN.BHD
 Tel. Int. + 60 (0) 3/60342788
 Fax Int. + 60 (0) 3/60342188

NL (Netherlands)
 Leuze electronic B.V.
 Tel. Int. + 31 (0) 418/653544
 Fax Int. + 31 (0) 418/653808

NO (Norway)
 Elteco AS
 Tel. Int. + 47 (0) 35/562070
 Fax Int. + 47 (0) 35/562099

PL (Poland)
 Balluff Sp. z o.o.
 Tel. Int. + 48 (0) 71/3384929
 Fax Int. + 48 (0) 71/3384930

PT (Portugal)
 LA2P, Lda.
 Tel. Int. + 351 (0) 21/4447070
 Fax Int. + 351 (0) 21/4447075

RO (Romania)
 O Boyle s.r.l.
 Tel. Int. + 40 (0) 56/201346
 Fax Int. + 40 (0) 56/221036

RU (Russian Federation)
 All Impax
 Tel. Int. + 7 495 9645164
 Fax Int. + 7 495 6031312

SE (Sweden)
 Leuze SensorGruppen AB
 Tel. + 46 (0) 8/7315190
 Fax + 46 (0) 8/7315105

SG + PH + ID (Singapore + Philippines + Indonesia)
 Balluff Asia Pte. Ltd.
 Tel. Int. + 65/68224384
 Fax Int. + 65/68229060

SI (Slovenia)
 Tipteh d.o.o.
 Tel. Int. + 3 86 (0) 1/2005150
 Fax Int. + 3 86 (0) 1/2005151

SK (Slovakia)
 Schmachtl SK s.r.o.
 Tel. Int. + 421 (0) 2/58275600
 Fax Int. + 421 (0) 2/58275601

TH (Thailand)
 Industrial Electrical Co. Ltd.
 Tel. Int. + 66 (0) 2/642-6700
 Fax Int. + 66 (0) 2/642-4249

TR (Turkey)
 Balluff Sensor Ltd. Sti.
 Tel. Int. + 90 (0) 212/3200411
 Fax Int. + 90 (0) 212/3200416

TW (Taiwan)
 Great Cofee Technology Co. Ltd.
 Tel. Int. + 886 (0) 2/29838077
 Fax Int. + 886 (0) 2/29853373

UA (Ukraine)
 Beverly-Foods Ltd.
 Tel. Int. + 38 044/5255927
 Fax Int. + 38 044/5257807

US + CA (United States + Canada)
 Leuze Lumiflex Inc.
 Tel. Int. + 1 (0) 248/4864466
 Fax Int. + 1 (0) 248/4866699

ZA (South Africa)
 Countapulse Controls (PTY) Ltd.
 Tel. Int. + 27 (0) 11/6157556
 Fax Int. + 27 (0) 11/6157513

© All rights reserved, especially the rights of production, distribution and translation. Copying or reproductions in any form require the written consent of the manufacturer. Product names are used without warranty of unrestricted applicability. Changes reflecting technical improvements may be made

1	General Information	4
1.1	Explanation of symbols	4
1.2	Important Terms.....	4
1.3	Declaration of Conformity	5
2	Safety Notices	6
2.1	Safety Standards	6
2.2	Intended Use.....	6
2.3	Working Safely	7
2.4	Organisational measures	8
3	Description ODSL 30	9
3.1	General description	9
3.2	Typical Areas of Application for the ODSL 30.....	10
3.2.1	Continuous Distance Measurement.....	10
3.2.2	Positioning Tasks.....	10
3.2.3	Collision prevention	11
3.3	Mounting	12
3.4	ODSL 30 Variants	13
3.4.1	ODSL 30/V... with Analogue Output.....	14
3.4.2	ODSL 30/24... with three switching outputs	18
3.4.3	ODSL 30/D... with Serial Output	19
3.5	Operation ODSL 30	27
3.5.1	LED indicators ODSL 30.....	27
3.5.2	Switching on	28
3.5.3	Adjustment of the display contrast.....	28
3.5.4	Reset to factory settings	28
3.5.5	Querying the device software version.....	29
3.5.6	Referencing the device.....	29
3.6	Configuration ODSL 30.....	30
3.6.1	Configuration / Menu Structure ODSL 30/V... (Analogue)	31
3.6.2	Configuration / menu structure ODSL 30/24/V... (3 switching outputs).....	33
3.6.3	Configuration / menu structure ODSL 30/D 232... (digital RS 232).....	36
3.6.4	Configuration / menu structure ODSL 30/D 485... (digital RS 485).....	40
3.6.5	Operating example	44
3.7	Advanced Menu (for software versions V01.10 and newer)	47
3.7.1	Setting an Offset/Preset Value - Compensating for Mounting Tolerances	47
3.7.2	Reduction in Measurement Time to as Little as 30ms	49
3.7.3	Changing the Display Resolution.....	50

4	Technical Data ODSL 30.....	51
4.1	Optical data.....	51
4.2	Electrical Data, Installation Data.....	52
4.2.1	ODSL 30/V-30M-S12.....	52
4.2.2	ODSL 30/24-30M-S12.....	52
4.2.3	ODSL 30/D 232-30M-S12.....	53
4.2.4	ODSL 30/D 485-30M-S12.....	53
4.3	Mechanical Data, Environmental Data.....	54
4.4	Dimensioned and Connection Drawings.....	55
4.5	Accessories.....	57
5	Installation.....	58
5.1	Storage, Transportation.....	58
5.2	Mounting.....	58
5.3	Teach-in.....	59
6	Software.....	61
6.1	Connection to a PC.....	61
6.1.1	Connection of the ODSL 30 to a PC.....	61
6.2	Installation of the ODS 96 configuration software.....	62
6.3	Starting the Program.....	62
6.3.1	Description of the Menu Commands.....	64
6.3.2	Measurement.....	65

Figure 2.1:	Stick-on label with warning notices	8
Figure 3.1:	Application example Positioning of Elevating Platforms.....	10
Figure 3.2:	Application example "Collision Prevention"	11
Figure 3.3:	ODSL 30 with BT 30.....	12
Figure 3.4:	Dimensioned drawing BT 30	12
Figure 3.5:	Characteristic output curve ODSL 30/V... with positive gradient	14
Figure 3.6:	Characteristic output curve ODSL 30/V... with negative gradient	14
Figure 3.7:	Behaviour of the switching outputs ODSL 30/24... (PNP output active high)	18
Figure 3.8:	Serial transmission formats ODSL 30/D...	20
Figure 3.9:	Voltage divider for the RS 485 bus termination.....	26
Figure 3.10:	Indicator and operating elements ODSL 30	27
Figure 3.11:	ODSL 30 measurement values with a uniqueness range of 9.8m.....	50
Figure 4.1:	Dimensioned drawing ODSL 30 variants	55
Figure 4.2:	Electrical Connection ODSL 30/V...	56
Figure 4.3:	Electrical Connection ODSL 30/24...	56
Figure 4.4:	Electrical Connection ODSL 30/D 232.....	56
Figure 4.5:	Electrical Connection ODSL 30/D 485.....	57
Figure 5.1:	View through a chase.....	58
Figure 6.1:	Connection of the ODSL 30 to a PC via the programming terminal UPG 5	61
Figure 6.2:	Installation directory	62
Figure 6.3:	Device selection	63
Figure 6.4:	Start menu before measurement.....	63
Figure 6.5:	Display of the current measurement values of the ODSL 30 connected.....	65

1 General Information

1.1 Explanation of symbols

The symbols used in this technical description are explained below.



Attention

Pay attention to passages marked with this symbol. Failure to heed this information may lead to injuries to personnel or damage to the equipment.



Attention Laser Radiation

This symbol warns of possible danger through hazardous laser radiation.



Notice

This symbol indicates text passages containing important information.

1.2 Important Terms

Phase measurement

Distance measuring procedure, which determines the distance of an object by the shift of the phase angle of the light reflected from the object.

Uniqueness range

Due to the periodicity of the sinusoid, the phasing of the signals received by the ODSL 30 limits the determination of unique measurement values to within a specific interval. The length of this interval is called the uniqueness range. A large uniqueness range is equivalent to high background suppression (see chapter 3.7.2).

Absolute measurement accuracy

Shows the possible divergence of the measurement value from the anticipated value through changes in the environmental conditions during the measuring process. Higher accuracy is given at constant environmental conditions.

Repeatability

Measuring distance change with repeated measurement at the same output signal (observe the same peripheral conditions as with resolution).

Resolution

The smallest possible distance change of the measured object, which causes a definite change in the output signal.

Reference measurement

Device function of the ODSL 30... for the compensation of a possible temperature drift. A reference measurement should be carried out before each exact measurement. The reference measurement is activated via a separate device input and is automatically carried out once after the device is switched on.

Diffuse reflection

Return and/or degree of reflection of the radiated light.

Measurement time

The measurement time is dependent on the selected uniqueness range and the luminosity coefficient of the object (see chapter 3.7.2).

Delay before start-up

The delay before start-up indicates the point in time when the first valid measurement can be obtained after switching on.

Light switching/Dark switching

Specifies the behaviour of the switching output: light switching if an object is located within the configured distance range, dark switching if an object is located outside of the configured distance range.

Insensitivity towards extraneous light

Indicates the insensitivity of the measurement result towards extraneous light. The ODSL 30 is reliably measuring even with extraneous light intensity of 5kLux. Typical light intensity in a work place is only 1kLux.

1.3 Declaration of Conformity

The optical distance sensors of the ODSL 30 series have been manufactured observing current European standards and guidelines.



Notice

The corresponding declaration of conformity can be requested from the manufacturer.

The manufacturer of the product, Leuze electronic GmbH + Co KG in D-73277 Owen/Teck, possesses a certified quality assurance system in accordance with ISO 9001.



2 Safety Notices

2.1 Safety Standards

The optical distance sensors of the ODSL 30 series have been developed, manufactured and tested, observing current safety standards. They correspond to the state of the art.

2.2 Intended Use



Attention

The protection of personnel and the device cannot be guaranteed if the device is operated in a manner not corresponding to its intended use.

Optical distance sensors of the ODSL 30 series are intelligent, adjustable sensors with CCD element for distance measuring.

In particular, unauthorised use includes:

- rooms with explosive atmospheres (zones 0, 1, 20, 21).
- operation for medical purposes

Areas of application

The optical distance sensors of the ODSL 30 series have been designed for the following areas of application:

- distance measurement
- contour determination
- positioning of side-tracking skates, cranes, lifting devices
- filling level measurement

2.3 Working Safely



Attention Laser Radiation!

The optical distance sensors ODSL 30 operate with a red light laser of class 2 acc. to EN 60825-1. If you look into the beam path over a longer time period, the retina of your eye may be damaged!

Never look directly into the beam path!

Do not point the laser beam of the ODSL 30 at persons!

When mounting and aligning the ODSL 30, take care to avoid reflections of the laser beam off reflective surfaces!

The use of operating and adjusting devices other than those specified in this technical description, carrying out of differing procedures, or improper use of the optical laser distance sensor may lead to dangerous exposure to radiation!

The use of optical instruments or devices in combination with the device increases the danger of eye damage!

Adhere to the applicable legal and local regulations regarding protection from laser beams acc. to EN 60825-1 in its latest version.

The ODSL 30 uses a laser diode with low power in the visible red light range with an emitted wavelength of about 655nm.

The glass optics cover is the only opening through which the laser radiation can escape from the device. The housing of the ODSL 30 is sealed and has no parts that need to be adjusted or maintained by the user. The device must not be tampered with and must not be changed in any way! The destruction of the seal voids the warranty!



Notice!

It is important that you attach the sticky labels supplied to the device (notice signs and laser emission symbol)! If the signs would be covered due to the installation situation of the ODSL 30, attach them close to the ODSL 30 such that reading the notices must not lead to looking into the laser beam!

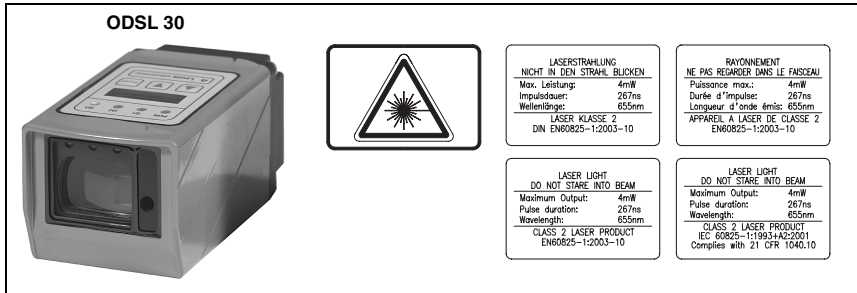

Figure 2.1: Stick-on label with warning notices



Attention

Access and changes to the device, except where expressly described in this operating manual, are not authorised.

2.4 Organisational measures

Documentation

All entries in this operating manual must be heeded, in particular those in section 2. Carefully store this technical description. It should be accessible at all times.

Safety regulations

Observe the locally applicable legal regulations and the rules of the employer's liability insurance association.

Qualified personnel

Mounting, commissioning and maintenance of the device must only be carried out by qualified personnel.

Electrical work must be carried out by a certified electrician.

Repair

Repairs must only be carried out by the manufacturer or an authorised representative.

3 Description ODSL 30

3.1 General description

The ODSL 30 is a laser distance measuring device with a large area of application. The equipment is available in different versions with analogue outputs, digital outputs, or switching outputs. The distance measurement uses the phase measurement principle. The measurement range lies between 0.2 ... 30m.

Integrated in the device are a keypad and a two-line LCD display which can be used to program the ODSL 30. During measurement operation, the display shows the current measurement value. The switching point of the switching outputs can easily be set via a teach input on all variants.



Remarks

Moving objects into the measurement beam from the side may lead to incorrect measurement values.

By carrying out the integrated reference measurement function before a measurement, the sensor's accuracy can be improved. To achieve this, the active input (Pin 2) can be configured via the menu to act either as an activation input with referencing, or as a pure referencing input. While the referencing function is carried out (duration about 0.3s), no measurement can be taken.

If the device is used in areas subject to electrostatic charges, it is recommended to connect the housing of the ODSL 30 to a common potential.

Accessories

The ODSL 30 ships with the mounting device BT 30 for easy mounting and alignment (further accessories see chapter 4.5).

3.2 Typical Areas of Application for the ODSL 30

3.2.1 Continuous Distance Measurement

All ODSL 30 variants with analogue/digital or switching output can be used for continuous distance measuring. The menu-guided configuration via key pad and LC display on the device without additional software permits the adaptation to a large number of applications.

Depending on position or settings of the ODSL 30, various applications are possible:

- Positioning of side-tracking skates, cranes, lifting devices
- Contour determination through controlled passing movement of an object through the beam of the ODSL 30.
- Volume measuring by taking measurements on two levels during the concurrent movement of the object.
- Determination of the diameter, e.g., on paper rolls.
- Measuring the thickness of planks with two opposing sensors and a differential of the two measured values.

3.2.2 Positioning Tasks

The ODSL 30 variants with analogue output and/or up to three teachable switching outputs are ideally suited for basic positioning tasks, such as the height/level adjustment of elevating platforms and rising floors.

The ODSL 30 is mounted in a way to enable positioning in the direction of the measuring beam.

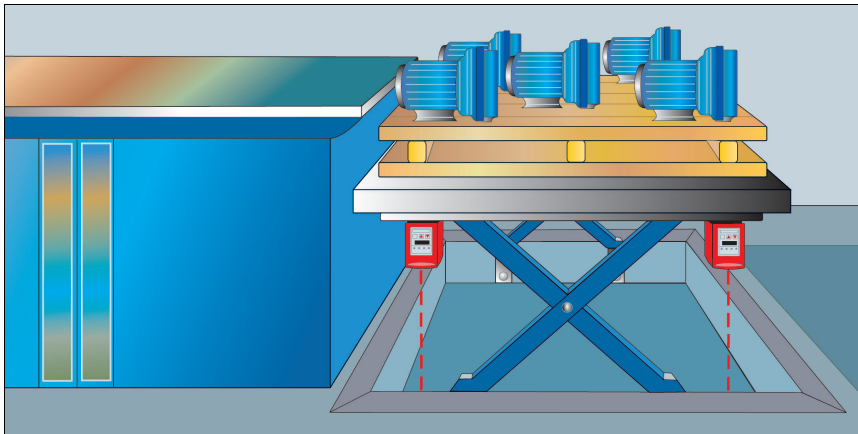

Figure 3.1: Application example Positioning of Elevating Platforms

3.2.3 Collision prevention

The ODSL 30 is ideally suited to be used as collision prevention device:

- Distance regulation via the analogue output of the ODSL 30
- Collision prevention via the switching outputs of the ODSL 30

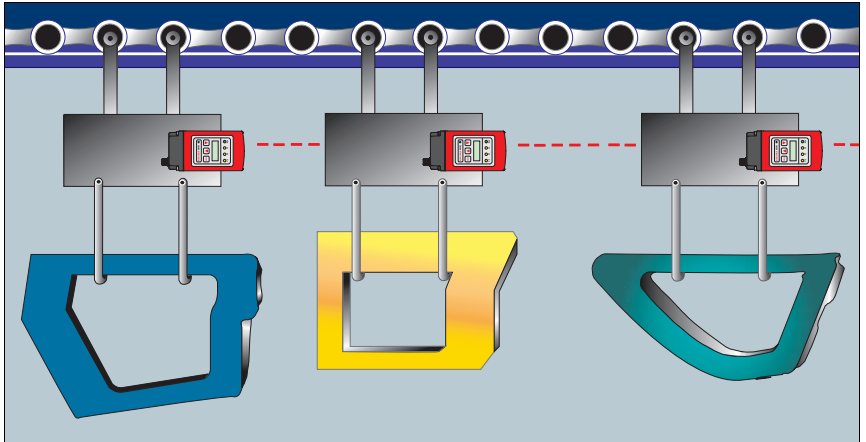

Figure 3.2: Application example "Collision Prevention"

**Notice**

With the help of the two aiming notches on the upper side of the device, you can carry out a coarse alignment of the ODSL 30 even before commissioning.

3.4 ODSL 30 Variants

Variants

The ODSL 30 is available in four variants:

- as a **laser distance sensor** with **2 analogue outputs 1 ... 10V and 4 ... 20mA** and **1 universally configurable switching output**
measurement range between 0.2 ... 30m
- as a **laser distance sensor** with **3 universally configurable switching outputs**
measurement range between 0.2 ... 30m
- as a **laser distance sensor** with **serial interface RS 232** and **2 universally configurable switching outputs**,
measurement range between 0.2 ... 30m
- as a **laser distance sensor** with **serial interface RS 485/RS 422** and **2 universally configurable switching outputs**,
measurement range between 0.2 ... 30m

3.4.1 ODSL 30/V... with Analogue Output

Analogue Output ODSL 30/V...

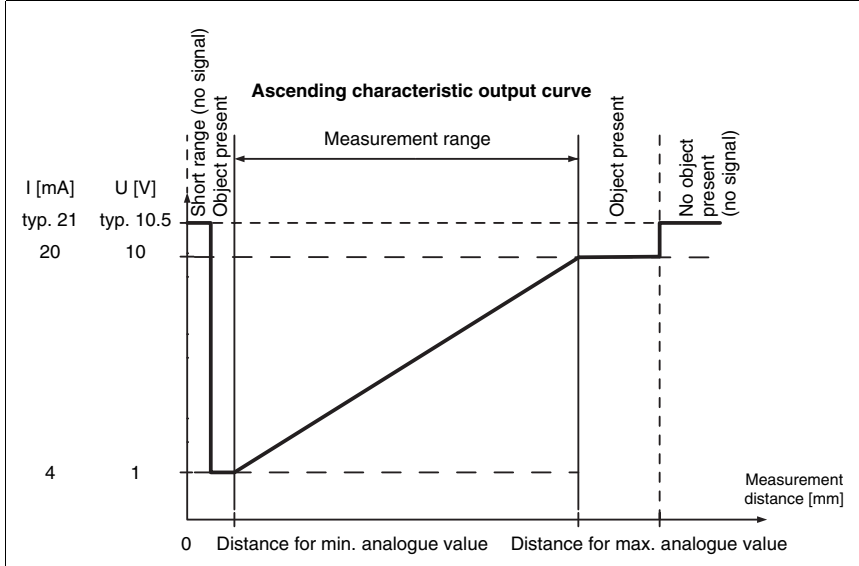

Figure 3.5: Characteristic output curve ODSL 30/V... with positive gradient

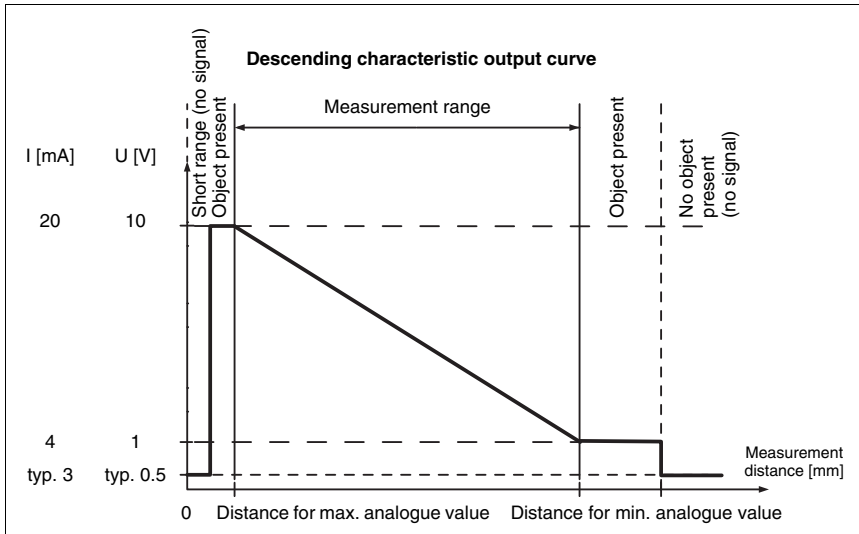

Figure 3.6: Characteristic output curve ODSL 30/V... with negative gradient

Behaviour of the analogue outputs of the ODSL 30/V...

The ODSL 30/V... has an analogue output with linear behaviour. A current output (4 ... 20mA) and a voltage output (1 ... 10V) are available to the user. In order to achieve the highest resolution possible, the range of the analogue output should be set as small as the application allows. The analogue output can be adjusted within the measurement range by configuration via the key pad and LCD display (adaptation of the characteristic output curve). The parameter `Cal. Ana. Output` determines whether the calibration is to be carried out for the current or voltage output. The characteristic output curve can be configured with a positive or negative gradient. For this purpose, the two distance values `Pos for min. val` and `Pos for max. val` for the minimum and maximum analogue output value are set accordingly in the range between 200mm and 30,000mm (see figure 3.5 and figure 3.6).

Object distance	Current output ¹⁾		Voltage output ²⁾	
	with positive gradient	with negative gradient	with positive gradient	with negative gradient
no object or object too close or too far away (no signal)	> 20.5mA (typ. 21 mA)	< 3.5mA (typ. 3mA)	> 10.25V (typ. 10.5V)	< 0.75V (typ. 0.5V)
= distance for minimum analogue value	4 mA	20mA	1V	10V
= distance for maximum analogue value	20mA	4 mA	10V	1V
< distance for minimum analogue value	4 mA	20mA	1V	10V
> distance for maximum analogue value	20mA	4 mA	10V	1V

- 1) The typical values only apply if the current output is calibrated.
- 2) The typical values only apply if the voltage output is calibrated.

Teach-in of the characteristic output curve

In addition to the edge-controlled teach-in (`slope control`) of the switching outputs, teach-in of the characteristic output curve is also possible via a teach line for devices with software version V01.10 and newer (see chapter 3.5.5). The following steps are required for the line teach-in of the analogue characteristic curve:

1. Activation of the analogue line teach function via the key pad and menu.
Activate `Input Menu -> Teach Mode -> Teach Mode time control`.
2. Position the measured object at the desired distance.
3. The respective teach function is activated by applying the active level (default +U_B) to the teach input "Teach Q1" (pin 5). The teach event is indicated by the flashing of the LEDs and on the display.

Teach function	Duration of teach signal	LED green	LED yellow
Upper switching point switching output Q1	2 ... 4s	flash synchronously	
Distance value for analogue output 1V / 4mA	4 ... 6s	continuous light	flashing
Distance value for analogue output 10V / 20mA	6 ... 8s	flashing	continuous light

4. To finish the teach event, disconnect the teach input from the teach signal after the desired time.
5. A successful teach event is signalled by the end of the flashing of the LEDs. The menu entries can be used to check that the teach values are properly accepted and to make any changes.

Error messages

Rapid flashing of the green LED following a teach event indicates an unsuccessful teach event. The sensor remains ready for operation and continues to function with the old values.

Remedy:

- Repeat teach event **or**
- Activate teach input for more than 8s **or**
- Disconnect sensor from voltage to restore the old values.

Behaviour of the switching output of the ODSL 30/V...

Additionally, a switching output with two switching points (switching window) is available with the ODSL 30/V... with analogue output. The upper switching point can be taught using a teach line. By configuring within the measurement range, it is possible to set the lower and upper switching points, the switching hysteresis, the switching behaviour (light/dark switching), and the type of switching output (PNP high active or NPN low active or PNP/NPN push-pull).

Teaching always takes place towards the upper switching point (see figure 3.7 on page 17). The lower switching point is set to 199mm by default.

Object distance	Light switching output Q1	Dark switching output Q1
No object (no signal)	off	on
< 200mm ¹⁾	on	off
< teach value	on	off
> teach value	off	on

- 1) Only if a received signal is available that can still be evaluated, otherwise same as "no object"

3.4.2 ODSL 30/24... with three switching outputs

Switching outputs ODSL 30/24...

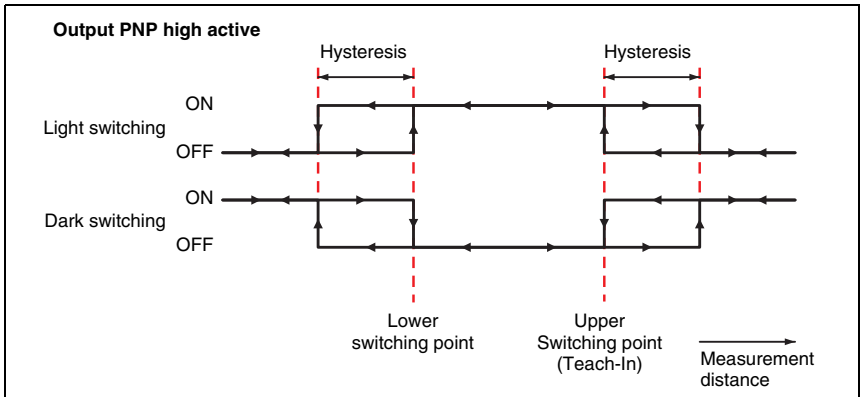

Figure 3.7: Behaviour of the switching outputs ODSL 30/24... (PNP output active high)

Behaviour of the switching outputs of the ODSL 30/24...

The ODSL 30/24... is equipped with three independent switching outputs, each with 2 switching points (switching windows). The upper switching points can be taught using a teach line. By configuring within the measurement range, it is possible to set the lower and upper switching points, the switching hysteresis, the switching behaviour (light/dark switching), and the type of switching output (PNP high active or NPN low active or PNP/NPN push-pull).

Teaching always takes place towards the upper switching point (see figure 3.7). Each of the lower switching points is set to 199mm by default.

Object distance	Light switching			Dark switching		
	output Q1	output Q2	output Q3	output Q1	output Q2	output Q3
No object (no signal)	off	off	off	on	on	on
< 200mm ¹⁾	on	on	on	off	off	off
< teach value	on	on	on	off	off	off
> teach value	off	off	off	on	on	on

1) Only if a received signal is available that can still be evaluated, otherwise same as "no object"

3.4.3 ODSL 30/D... with Serial Output

Transmission formats

The ODSL 30/D... has 2 digital switching outputs and one serial interface which is implemented either as an RS 232 interface or as an RS 485/RS 422 interface. The transmission rate can be set to between 600 and 115200 baud.

The serial transmission is carried out with 1 start bit, 8 data bits and 1 or 2 stop bits without parity.

For the transmission of the measurement values, 6 different transmission modes may be configured (see figure 3.8):

- **ASCII measurement value**
(7 bytes, measurement range 0 ... 30m, resolution 1 mm)¹⁾
- **ASCII measurement value 0.1 mm**
(7 bytes, measurement range 0 ... 30m, resolution 0.1 mm)¹⁾
- **14 bit measurement value**
(2 bytes, measurement range 0 ... 15m, resolution 1 mm)¹⁾
- **16 bit measurement value**
(3 bytes, measurement range 0 ... 30m, resolution 1 mm)¹⁾
- **20 bit measurement value**
(4 bytes, measurement range 0 ... 30m, resolution 0.1 mm)¹⁾
- **Remote Control Operation**
(Remote Control)²⁾

The output format is activated by configuration with the key pad and menu.



Notice!

Selecting an output resolution of 0.1 mm does not change the internal measurement system of the ODSL 30 and does not increase its accuracy. For this reason, measurement values with a resolution of 0.1 mm may vary in successive measurements depending on the application.

1) Continuous measured value output in a 100ms grid. For the ODSL 30/D 485..., the transfer is carried out in RS 422 mode, i.e., with permanent transmission on the Tx+ and Tx- lines.

2) For the ODSL 30/D 485..., the transfer is carried out in RS 485 mode, i.e., the Tx+ and Tx- lines are switched to receive. This permits several ODSL 30/D 485... to be connected onto a single bus. In this case, the device addresses of the individual devices must differ from each other.

The ODSL 30/D 232... can also be operated via remote control, however, only as a point-to-point-connection between the ODSL 30 and the controller.

Measurement value output for various transmission types

Object distance	Measurement value output for transmission type							
	ASCII 5 bytes	ASCII 6 bytes	14 bit	16 bit	20 bit	Remote 4 bytes	Remote 5 bytes	Remote 6 bytes
No object (no signal)	65535	655350	16383	65535	655350	9999	65535	655350
< 200mm ¹⁾	Distance value in mm	Distance value in 1/10mm	Distance value in mm	Distance value in mm	Distance value in 1/10mm	Distance value in mm	Distance value in mm	Distance value in 1/10mm
200mm ... 9900mm	Distance value in mm	Distance value in 1/10mm	Distance value in mm	Distance value in mm	Distance value in 1/10mm	Distance value in mm	Distance value in mm	Distance value in 1/10mm
9901mm ... 16000mm	Distance value in mm	Distance value in 1/10mm	Distance value in mm	Distance value in mm	Distance value in 1/10mm	9901	Distance value in mm	Distance value in 1/10mm
16001mm ... 65000mm	Distance value in mm	Distance value in 1/10mm	16001	Distance value in mm	Distance value in 1/10mm	9901	Distance value in mm	Distance value in 1/10mm
> 65000mm	65001	650010	16001	65001	650010	9901	65001	650010
Object distance + Offset > 65000mm (Offset Direction neg.)	65001	650010	16001	65001	650010	9901	65001	650010
Object distance - Offset < 0mm (Offset Direction pos.)	0	0	0	0	0	0	0	0
Device error	0	0	0	0	0	0	0	0

1) Only if a received signal is available that can still be evaluated, otherwise same as "no object"

Commands for remote control operation

For remote control operation (parameter `Remote Control`), a device address between 0 ... 14 can be set. In this operating mode, the ODSL 30/D... reacts only to commands from the controller. The following control commands are available:

Commands for the asynchronous measurement

Query of 4-digit measurement value

(ODS 96 compatible, bus operation ODSL 30/D ...):

	Byte No.									Response time
	0	1	2	3	4	5	6	7	8	
Command	Sensor address 0x00 through 0x0E	-	-	-	-	-	-	-	-	
Sensor response	"*#" (0x2A)	ASCII address tens ones		ASCII-distance measurement value thousands hundreds tens ones				"##" (0x23)	-	max. 120ms

Asynchronous query of 5-digit measurement value (bus operation ODSL 30/D ...):

	Byte No.									Response time				
	0	1	2	3	4	5	6	7	8					
Command	"*" (0x2A)	ASCII address "0...9", "A...D"	"M" (0x4D)	"##" (0x23)	-	-	-	-	-					
Sensor response	"*" (0x2A)	ASCII address "0...9", "A...D"	ASCII-distance measurement value ten thou- sands					thous- sands	hun- dreds	tens	ones	Status	"##" (0x23)	max. 120ms

Asynchronous query of 6-digit measurement value (bus operation ODSL 30/D ...):

	Byte No.										Response time ¹⁾					
	0	1	2	3	4	5	6	7	8	9						
Command	"*" (0x2A)	ASCII address "0...9", "A...D"	"M" (0x73)	"##" (0x23)	-	-	-	-	-	-						
Sensor response	"*" (0x2A)	ASCII address "0...9", "A...D"	ASCII-distance measurement value ten thou- sands						thous- sands	hun- dreds	tens	ones	tenths	Status	"##" (0x23)	30 ... 100ms

The two following synchronous measurement commands "S" (5-digit measurement value, resolution 1 mm) or "s" (6-digit measurement value, resolution 0.1 mm) enable the start of a measurement at a precise time.

If a synchronous measurement value is requested via remote control operation:

- this command immediately switches on the laser and triggers the measurement.
- following the measurement cycle, the laser is switched off.
- the measured value is transmitted following this measurement cycle (default: 100ms).



Notice!

Prerequisite for the function of the synchronous measurement value query is that the sensor be deactivated (laser off)!

For this purpose:

- the active/reference input (pin 2) must be connected to the inactive state (default: 0V) or it must be open.
- the active/reference input (pin 2) must be configured as an activation and referencing input:

Input Menu -> Input actiw/ref -> input actiw/ref Activation + Ref

Commands for the synchronous measurement

Synchronous query of 5-digit measurement value, res. 1 mm (bus operation ODSL 30/D ...):

	Byte No.										Response time ¹⁾
	0	1	2	3	4	5	6	7	8	9	
Command	"*" (0x2A)	ASCII address "0...9", "A...D"	"S" (0x53)	"#" (0x23)	-	-	-	-	-	-	
Sensor response	"*" (0x2A)	ASCII address "0...9", "A...D"	ASCII-distance measurement value ten thousands thousands hundreds tens ones					Status	"#" (0x23)	-	30 ... 100ms

Synchronous query of 6-digit measurement value, res. 0.1mm (bus operation ODSL 30/D ...):

	Byte No.										Response time ¹⁾
	0	1	2	3	4	5	6	7	8	9	
Command	"*" (0x2A)	ASCII address "0...9", "A...D"	"S" (0x73)	"#" (0x23)	-	-	-	-	-	-	
Sensor response	"*" (0x2A)	ASCII address "0...9", "A...D"	ASCII-distance measurement value ten thousands thousands hundreds tens ones tenths					Status	"#" (0x23)	30 ... 100ms	

1) Depending on the configuration of the measurement time, see chapter 3.7 "Advanced Menu (for software versions V01.10 and newer)", duration of data transmission not included.



Notice!

To make the laser beam visible for adjustment purposes and to view measurement values on the display, the

- active/reference input (pin 2) can be connected to the active state (default: 24 V) or
- the sensor can be activated with the command "A" (see page 23) or
- the active/reference input (pin 2) can be temporarily configured via the menu as a reference input:

Input Menu -> Input activ/ref -> Input activ/ref Referencins

Possible errors and their causes

Instead of a synchronous measurement, an asynchronous measurement is performed.

Possible causes of the error: the synchronous measurement command was set by the activated, i.e. the measuring, sensor. Instead of the synchronous measurement, an asynchronous measurement was performed (corresponds to the commands "M" and "m").

Further commands

Activation of referencing (bus operation for ODSL 30/D ...):

	Byte No.									Response time	
	0	1	2	3	4	5	6	7	8		
Command	"*" (0x2A)	ASCII address "0...9", "A...D"	"R" (0x52)	"#" (0x23)	-	-	-	-	-	-	
Sensor response	"*" (0x2A)	ASCII address "0...9", "A...D"	Status	"#" (0x23)	-	-	-	-	-	-	350ms

Sensor activation ¹⁾ (bus operation for ODSL 30/D ...):

	Byte No.									Response time	
	0	1	2	3	4	5	6	7	8		
Command	"*" (0x2A)	ASCII address "0...9", "A...D"	"A" (0x41)	"#" (0x23)	-	-	-	-	-	-	
Sensor response	"*" (0x2A)	ASCII address "0...9", "A...D"	Status	"#" (0x23)	-	-	-	-	-	-	max. 120ms

Deactivating the sensor ¹⁾ (bus operation for the ODSL 30/D ...):

	Byte No.									Response time	
	0	1	2	3	4	5	6	7	8		
Command	"*" (0x2A)	ASCII address "0...9", "A...D"	"D" (0x44)	"#" (0x23)	-	-	-	-	-	-	
Sensor response	"*" (0x2A)	ASCII address "0...9", "A...D"	Status	"#" (0x23)	-	-	-	-	-	-	max. 120ms

Status byte (bitwise processing):

Bit number	Value	Meaning
7 (MSB)	0x80	always = 0 (reserved)
6	0x40	1 = other error, 0 = OK
5	0x20	always = 1, if the status is 0x20, the sensor functions flawlessly
4	0x10	always = 0 (reserved)
3	0x08	always = 0 (reserved)
2	0x04	1 = sensor deactivated, 0 = sensor activated
1	0x02	1 = no signal or signal too low, 0 = signal OK
0 (LSB)	0x01	1 = Laser defective, 0 = Laser OK

1) The sensor is activated by default and in this case cannot be deactivated via the control command. The control command is only effective if the input activ/ref is configured as an activation and referencing input. In this case, the following applies: The sensor is activated if the input activ/ref is at active level **or** if the sensor is activated via control command. The sensor is deactivated if the input activ/ref is not at active level **and** the sensor is deactivated via control command.

Behaviour of the switching outputs of the ODSL 30/D...

In addition, the ODSL 30/D... with serial output also has two switching outputs. The position within the measuring range at which the switching outputs become active can be set arbitrarily via a teach line or via configuration. In addition to the switching points, it is also possible to configure the switching hysteresis, the switching behaviour (light/dark switching), and the type of switching output (PNP high active or NPN low active or PNP/NPN push-pull). Generally, teaching always takes place towards the switching point (see figure 3.7 on page 17).

Object distance	Light switching		Dark switching	
	output Q1	output Q2	output Q1	output Q2
No object (no signal)	off	off	on	on
< 200mm ¹⁾	on	on	off	off
< teach value	on	on	off	off
> teach value	off	off	on	on

1) Only if a received signal is available that can still be evaluated, otherwise same as "no object"

Notes regarding the termination of the data lines of the ODSL 30/D 485...

The ODSL 30/D 485... features a combined transmitter and receiver component that can transmit serial data according to the RS 485 and RS 422 standard (see TIA/EIA-485-A or DIN66259, Part 3).

These standards define some basic rules that should be followed in order to achieve the most reliable data transmission:

- The data lines A and B (which correspond to the ODSL 30 pins Tx+ and Tx-) are connected to an intrinsic impedance of $Z_0 \approx 120\Omega$ via a 2-wire twisted pair cable.
- The end of the data line (and the beginning in case of RS 485) is terminated using a 120Ω resistor. The ODSL 30/D 485... does not have an internal bus termination.
- The RS 485 bus participants are wired in an in-line bus topology, i.e., the data line is fed from one bus participant to the next. Cable stubs are to be avoided or to be kept as short as possible.
- The RS 485 specification assumes an inactive potential difference of $U_{AB} \geq 200\text{mV}$ between the data cables. A bus termination in the form of a voltage divider should be implemented in order to maintain this level. Usually, it is connected to the RS 485 coupling module of the PLC.

The RS 485 specification permits transmission rates in the megabit range for up to 32 participants. The ODSL 30/D 485... is designed for a data transmission rate of typically 9600 Baud (600 ... 115200 Baud may be configured). In practice, this means that the strict requirements regarding the bus termination and the cabling are "softened" for a few bus participants.

However, it is important to maintain the bus idle levels ($U_{AB} \geq 200\text{mV}$). If the PLC coupling module does not include a bus termination with voltage divider, the following circuit may be used.

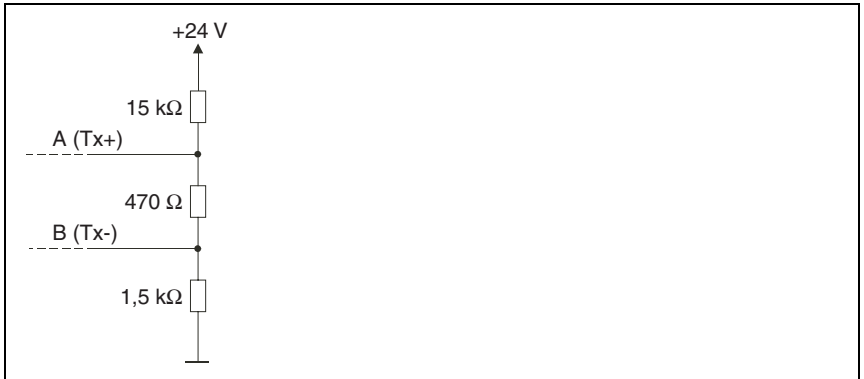

Figure 3.9: Voltage divider for the RS 485 bus termination

The RS 422 connection does not require a bus termination for cable lengths up to about 20m and data transmission rates less than 9600 Baud.

Further information:

- RS 422: Electrical Specification acc. to DIN 66259, Part 3
- ISO 8482: Abstract
Specifies the physical medium characteristics for twisted pair multipoint interconnections in either 2-wire or 4-wire network topology, a binary and bi-directional signal transfer, the electrical and mechanical design of the endpoint system branch cables and the common trunk cable which may be up to 1200m in length, the component measurements of the integrated type generators and receivers within the endpoint system, the applicable data signalling rate up to 12.5Mbit/s.

3.5 Operation ODSL 30

Indicator and operating elements

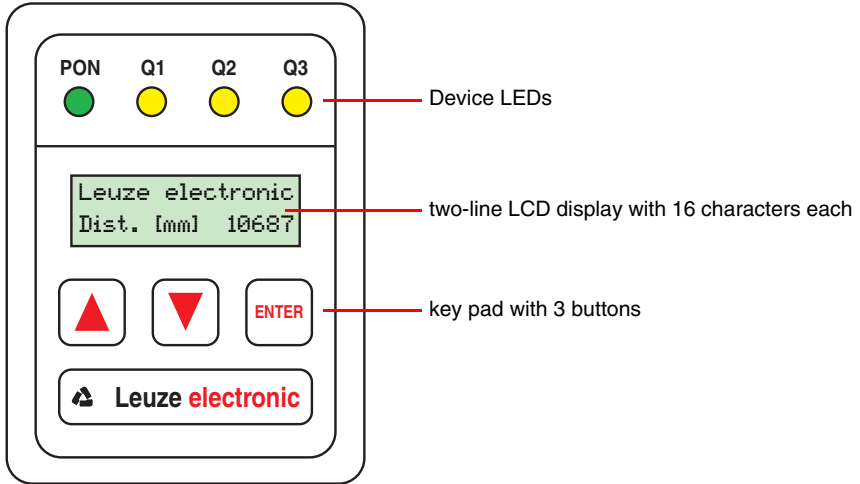

Figure 3.10: Indicator and operating elements ODSL 30

3.5.1 LED indicators ODSL 30

LED	Colour	Display when	
		Sensor operation	activated teach-in characteristic output curve ¹⁾
PON	green permanent light	ready	Teach-in procedure
	green flashing	–	Teach-in procedure
	green off	no voltage	
Q1, Q2, Q3	yellow permanent light	object inside teach-in measurement distance	Teach-in procedure
	yellow flashing	–	Teach-in procedure
	yellow off	object outside teach-in measurement distance or no signal present	

1) The teach-in process is described in detail in section 3.4.1 and section 5.3



Notice

The 3 yellow LEDs Q1, Q2 and Q3 for the status display of the up to 3 switching outputs are additionally located in the optical window of the ODSL 30. Only the LEDs for those switching outputs that are actually available in the respective device version have a function.

3.5.2 Switching on

After power-on and error-free initialisation of the device, the green LED **PON** lights up continuously, the ODSL 30 is measurement mode. The display lighting remains switched off.

```
Leuze electronic
Dist. [mm] 10687
```

In measurement mode, the LCD display shows the current measurement value in millimetres. If no object is detected or if the signal is too weak, the notice **NO SIGNAL** appears on the display.



Notice

After an operating time of 30 min., the device has reached the operating temperature required for an optimal measurement and should be referenced then.

3.5.3 Adjustment of the display contrast

While switching the device on, press both arrow keys of the ODSL 30 simultaneously.

```
contrast: 160
```

After releasing the keys, you can decrease or increase the contrast of the LCD display with the arrow keys (value range 0 ... 255). By pressing ENTER, the adjusted contrast value is applied and you get to the configuration menu of the ODSL 30.

3.5.4 Reset to factory settings

By pressing ENTER while switching the device on, you can reset the configuration of the ODSL 30 to the state upon delivery.

A safety prompt appears.

```
Default Settings?
Press ↵ for OK
```

By pressing ENTER again, all parameters are reset to factory settings. All settings made previously are permanently lost. By pressing an arrow key, the ODSL 30 returns to measurement operation without resetting the parameters.

3.5.5 Querying the device software version

You can query the device software version in the menu for configuring the ODSL 30. To do this, select the following menu item in the Service Menu:

SW V01.20 YYMMDD
Val: 31024

<- Software version **V0x.xx** with date (YY = year, MM = month, DD = day)

3.5.6 Referencing the device

The ODSL 30 is equipped with a referencing function for internally calibrating the sensor.

By carrying out the integrated reference measurement function before a measurement, the sensor's accuracy can be improved.

A referencing operation is performed

- **when switching on** the device (Power-On).
- **by means of a signal** at the activation/referencing input (PIN 2).
- **by means of a command** in remote control operation (ODSL 30/D... only).



Notice

In particular, the referencing function should be performed for changing environmental conditions.

While the referencing function is carried out (duration about 350ms), no measurement can be taken.

3.6 Configuration ODSL 30

Configuration / navigation in the menu

By pressing an arbitrary key, the LCD display illumination is switched on, and the configuration menu of the ODSL 30 appears.

- ↵ **You can scroll through the menu items using the arrow keys.**
- ↵ **You can select the individual menu items by pressing ENTER.**
- ↵ **If a value or parameter can be changed, a cursor flashes. You can change this value or parameter by using the arrow keys. You apply the setting by pressing ENTER.**
- ↵ **Via the menu item "Return", you return to the parent level in the menu structure.**
- ↵ **Via the menu item "Exit from Menu", you return to the measurement mode.**



Notice

Values that can be toggled or edited are shown in red (PDF file) or grey (b/w print of the manual) in the menu structure.

If no key is pressed for 60s in the configuration menu, the device automatically returns to the measurement mode.

The device can be protected against unauthorised configuration change by activating the password query. The **password** is always set to "**165**".

3.6.1 Configuration / Menu Structure ODSL 30/V... (Analogue)

Level 1	Level 2	Level 3	Level 4	Explanation / Notes	Default	
 <p>Notice</p> <p>The functions under Applic. Param. are not available until the Advanced Menu is activated (see chapter 3.7)</p>	Applic. Param.	Tmeas Band Rem. 100ms 150m 6-90%	Tmeas Band Rem. 100ms 150m 6-90%	Measurement time / uniqueness range / object reflectivity	X	
		Tmeas Band Rem. 80ms 39m 6-90%	Tmeas Band Rem. 70ms 9.8m 6-90%	Measurement time / uniqueness range / object reflectivity		
		Tmeas Band Rem. 50ms 150m 50-90%	Tmeas Band Rem. 40ms 39m 50-90%	Measurement time / uniqueness range / object reflectivity		
		Tmeas Band Rem. 30ms 9.8m 50-90%	Tmeas Band Rem. 30ms 9.8m 50-90%	Measurement time / uniqueness range / object reflectivity		
		Disp. Resolution 1mm	Disp. Resolution 1mm	Display resolution 1 mm	X	
			Disp. Resolution 0.1mm	Display resolution 0.1 mm		
		Offset/Preset	Offset Direction ... Positive	Offset Direction ... Positive	Offset sign positive	X
				Offset Direction ... Negative	Offset sign negative	
			Offsetvalue [mm] Value: 000000	Offsetvalue [mm] act Val. 000000	Offset value, entry in mm	0
			Presetvalue [mm] Value: 000000	Presetvalue [mm] act Val. 000000	Preset value, entry in mm	0
			Preset Calculate ... inactive	Preset Calculate ... active	Trigger of the preset function	
		Return			Return to level 1	
		Input Menu	Inf. teach Q1/Q2 Teach Out Q1/Q2	Inf. teach Q1/Q2 Teach Out Q1/Q2	Teach input is activated	X
				Inf. teach Q1/Q2 Input disabled	Teach input is deactivated	
			Input activ/ref Referencins	Input activ/ref Referencins	Input is referencing input	X
Input activ/ref Activation + Ref	Input is activation and referencing input					
Input activ/ref Input disabled	Input activ is deactivated					
Input Polarity active HIGH +24V	Input Polarity active HIGH +24V		All inputs are active high	X		
	Input Polarity active LOW 0V		All inputs are active low			
Teach Mode slope control	Teach Mode slope control		Teach-in, slope controlled	X		
	Teach Mode time control		Teach-in, time controlled			
Return				Return to level 1		

Level 1	Level 2	Level 3	Level 4	Explanation / Notes	Default
Output Q Menu	Q1 Function sel.	Q1 Upper Sw. Pt. Value: 001000	Q1 Upper Sw. Pt. act Value: 001000	Upper switching point of output Q1 in millimetres	1000
		Q1 Lower Sw. Pt. Value: 000199	Q1 Lower Sw. Pt. act Value: 000199	Lower switching point of output Q1 in millimetres	199
		Q1 Hysteresis Value: 000020	Q1 Hysteresis act Value: 00020	Switching hysteresis of output Q1 in millimetres	20
		Q1 light/dark light switching	Q1 light/dark light switching	Q1 is active if an object is present in the switching range	X
			Q1 light/dark dark switching	Q1 is active if no object is present in the switching range	
		Q1 Driver PNP high active	Q1 Driver PNP high active	Q1 is high-side output (PNP)	X
Return	Return	Q1 Driver NPN low active	Q1 is low-side output (NPN)		
		Q1 Driver PNP/NPN pushpull	Q1 is push-pull output		
			Return to level 2		
	Return		Return to level 1		
Analogue Menu	Out	Cal. Ana. Output Current 4-20mA	Cal. Ana. Output Current 4-20mA	Current output calibrated, Voltage output uncalibrated	X
			Cal. Ana. Output Voltage 1-10V	Voltage output calibrated, Current output uncalibrated	
		Pos for max. val Value: 005000	Pos for max. val act Value: 05000	Distance [mm], at which the max. analogue value is output	5000
		Pos for min. val Value: 000200	Pos for min. val act Value: 00200	Distance [mm], at which the min. analogue value is output	200
		Return		Return to level 1	
Service Menu	Password Check inactive	Password Check inactive		Password for menu access not active	X
		Password Check activated		Password for menu access active, password: 165 (can not be changed)	
	ODSL 30Serial No Val:99999		Display of serial number, no changes possible		
	SW V01.20VYMMDD Val:31024		Display of software version, no changes possible		
	ParameterVYMMDD Val:31024		Display of parameter version, no changes possible		
	Interface-Type Analogue Inter- face		Display of the interface type, no changes possible		
Return		Return to level 1			
Exit from Menu				Return to measurement mode	

3.6.2 Configuration / menu structure ODSL 30/24/V... (3 switching outputs)

Level 1	Level 2	Level 3	Level 4	Explanation / Notes	Default		
 Notice The functions under Applic. Param. are not available until the Advanced Menu is activated (see chapter 3.7)	Applic. Param. Tmeas Band Rem. 100ms 150m 6-90%	Tmeas Band Rem. 100ms 150m 6-90%		Measurement time / uniqueness range / object reflectivity	X		
		Tmeas Band Rem. 80ms 39m 6-90%		Measurement time / uniqueness range / object reflectivity			
		Tmeas Band Rem. 70ms 9.8m 6-90%		Measurement time / uniqueness range / object reflectivity			
		Tmeas Band Rem. 50ms 150m 50-90%		Measurement time / uniqueness range / object reflectivity			
		Tmeas Band Rem. 40ms 39m 50-90%		Measurement time / uniqueness range / object reflectivity			
		Tmeas Band Rem. 30ms 9.8m 50-90%		Measurement time / uniqueness range / object reflectivity			
		Disp. Resolution 1mm	Disp. Resolution 1mm	Disp. Resolution 1mm		Display resolution 1 mm	X
				Disp. Resolution 0.1mm		Display resolution 0.1 mm	
		Offset/Preset		Offset Direction ... Positive	Offset Direction ... Positive	Offset sign positive	X
	Offset Direction ... negative			Offset sign negative			
	Offsetvalue [mm] Value: 000000		Offsetvalue [mm] act Val. 000000	Offset value, entry in mm	0		
	Presetvalue [mm] Value: 000000		Presetvalue [mm] act Val. 000000	Preset value, entry in mm	0		
	Preset Calculate ... inactive		Preset Calculate ... active	Trigger of the preset function			
Return				Return to level 1			
Input Menu	Inf. teach Q1/Q2 Teach Out Q1/Q2	Inf. teach Q1/Q2 Teach Out Q1/Q2		Teach input is activated	X		
		Inf. teach Q1/Q2 Input disabled		Teach input is deactivated			
	Input activ/ref Referencins		Input activ/ref Referencins		Input is referencing input	X	
			Input activ/ref Activation + Ref		Input is activation and referencing input		
			Input activ/ref Input disabled		Input activ is deactivated		
	Inf. teach Q3 Teach output Q3	Inf. teach Q3 Teach Output Q3	Inf. teach Q3 Teach Output Q3		Teach input is activated	X	
			Inf. teach Q3 Input disabled		Teach input is deactivated		
	Input Polarity active HIGH +24V		Input Polarity active HIGH +24V		All inputs are active high	X	
			Input Polarity active LOW 0V		All inputs are active low		
	Return			Return to level 1			

Level 1	Level 2	Level 3	Level 4	Explanation / Notes	Default		
Output Q Menu	Q1 Function sel.	Q1 Upper Sw. Pt. Value: 001000	Q1 Upper Sw. Pt. act Value: 001000	Upper switching point of output Q1 in millimetres	1000		
		Q1 Lower Sw. Pt. Value: 000199	Q1 Lower Sw. Pt. act Value: 000199	Lower switching point of output Q1 in millimetres	199		
		Q1 Hysteresis Value: 000020	Q1 Hysteresis act Value: 000020	Switching hysteresis of output Q1 in millimetres	20		
		Q1 light/dark light switching	Q1 light/dark light switching	Q1 is active if an object is present in the switching range	X		
			Q1 light/dark dark switching	Q1 is active if no object is present in the switching range			
		Q1 Driver PNP high active	Q1 Driver PNP high active	Q1 is high-side output (PNP)	X		
			Q1 Driver NPN low active	Q1 is low-side output (NPN)			
			Q1 Driver PNP/NPN pushpull	Q1 is push-pull output			
		Return				Return to level 2	
		Q2 Function sel.	Q2 Function sel.	Q2 Upper Sw. Pt. Value: 001500	Q2 Upper Sw. Pt. act Value: 001500	Upper switching point of output Q2 in millimetres	1500
Q2 Lower Sw. Pt. Value: 000199	Q2 Lower Sw. Pt. act Value: 000199			Lower switching point of output Q2 in millimetres	199		
Q2 Hysteresis Value: 000020	Q2 Hysteresis act Value: 000020			Switching hysteresis of output Q2 in millimetres	20		
Q2 light/dark light switching	Q2 light/dark light switching			Q2 is active if an object is present in the switching range	X		
	Q2 light/dark dark switching			Q2 is active if no object is present in the switching range			
Q2 Driver PNP high active	Q2 Driver PNP high active			Q2 is high-side output (PNP)	X		
	Q2 Driver NPN low active			Q2 is low-side output (NPN)			
	Q2 Driver PNP/NPN pushpull			Q2 is push-pull output			
Return						Return to level 2	
Q3 Function sel.	Q3 Function sel.			Q3 Upper Sw. Pt. Value: 002000	Q3 Upper Sw. Pt. act Value: 002000	Upper switching point of output Q3 in millimetres	2000
		Q3 Lower Sw. Pt. Value: 000199	Q3 Lower Sw. Pt. act Value: 000199	Lower switching point of output Q3 in millimetres	199		
		Q3 Hysteresis Value: 000020	Q3 Hysteresis act Value: 000020	Switching hysteresis of output Q3 in millimetres	20		
		Q3 light/dark light switching	Q3 light/dark light switching	Q3 is active if an object is present in the switching range	X		
			Q3 light/dark dark switching	Q3 is active if no object is present in the switching range			
		Q3 Driver PNP high active	Q3 Driver PNP high active	Q3 is high-side output (PNP)	X		
			Q3 Driver NPN low active	Q3 is low-side output (NPN)			
			Q3 Driver PNP/NPN pushpull	Q3 is push-pull output			
		Return				Return to level 2	
		Return				Return to level 1	

Level 1	Level 2	Level 3	Level 4	Explanation / Notes	Default
Service Menu	Password Check inactive	Password Check inactive		Password for menu access not active	x
		Password Check activated		Password for menu access active, password: 165 (can not be changed)	
	ODSL 30 Serial No Val: 99999			Display of serial number, no changes possible	
	SW V01.20 VVMDD Val: 31024			Display of software version, no changes possible	
	Parameter VVMDD Val: 31024			Display of parameter version, no changes possible	
	Interface-Type 3 Outp. 01-02-03			Display of the interface type, no changes possible	
	Return			Return to level 1	
Exit from Menu				Return to measurement mode	

3.6.3 Configuration / menu structure ODSL 30/D 232... (digital RS 232)

Level 1	Level 2	Level 3	Level 4	Explanation / Notes	Default	
 <p>Notice</p> <p>The functions under Applic. Param. are not available until the Advanced Menu is activated (see chapter 3.7)</p>	Timeas Band Rem. 100ms 150m 6-90%	Timeas Band Rem. 100ms 150m 6-90%		Measurement time / uniqueness range / object reflectivity	X	
		Timeas Band Rem. 80ms 39m 6-90%		Measurement time / uniqueness range / object reflectivity		
		Timeas Band Rem. 70ms 9.8m 6-90%		Measurement time / uniqueness range / object reflectivity		
		Timeas Band Rem. 50ms 150m 50-90%		Measurement time / uniqueness range / object reflectivity		
		Timeas Band Rem. 40ms 39m 50-90%		Measurement time / uniqueness range / object reflectivity		
		Timeas Band Rem. 30ms 9.8m 50-90%		Measurement time / uniqueness range / object reflectivity		
	Disp. Resolution 1mm	Disp. Resolution 1mm			Display resolution 1mm	X
			Disp. Resolution 0.1mm		Display resolution 0.1mm	
	Offset/Preset	Offset Direction ... Positive	Offset Direction ... Positive		Offset sign positive	X
				Offset Direction ... negative	Offset sign negative	
Offsetvalue [mm] Value: 000000		Offsetvalue [mm] act Val. 000000		Offset value, entry in mm	0	
			Presetvalue [mm] Value: 000000	Presetvalue [mm] act Val. 000000	Preset value, entry in mm	0
Preset Calculate ... inactive	Preset Calculate ... active		Trigger of the preset function			
Return				Return to level 1		
Input Menu	Inf. teach Q1/Q2 Teach Out Q1/Q2	Inf. teach Q1/Q2 Teach Out Q1/Q2		Teach input is activated	X	
		Inf. teach Q1/Q2 Input disabled		Teach input is deactivated		
	Input activ/ref Referencins	Input activ/ref Referencins	Input activ/ref Activation + Ref		Input is referencing input	X
			Input activ/ref Input disabled		Input is activation and referencing input	
			Input activ/ref Input disabled		Input activ is deactivated	
	Input Polarity active HIGH +24V	Input Polarity active HIGH +24V	Input Polarity active HIGH +24V		All inputs are active high	X
			Input Polarity active LOW 0V		All inputs are active low	
	Return				Return to level 1	

Level 1	Level 2	Level 3	Level 4	Explanation / Notes	Default
Output Q Menu	Q1 Function sel.	Q1 Upper Sw. Pt. Value: 001000	Q1 Upper Sw. Pt. act Value: 001000	Upper switching point of output Q1 in millimetres	1000
		Q1 Lower Sw. Pt. Value: 000199	Q1 Lower Sw. Pt. act Value: 000199	Lower switching point of output Q1 in millimetres	199
		Q1 Hysteresis Value: 000020	Q1 Hysteresis act Value: 00020	Switching hysteresis of output Q1 in millimetres	20
		Q1 light/dark light switching	Q1 light/dark light switching	Q1 is active if an object is present in the switching range	X
			Q1 light/dark dark switching	Q1 is active if no object is present in the switching range	
		Q1 Driver PNP high active	Q1 Driver PNP high active	Q1 is high-side output (PNP)	X
			Q1 Driver NPN low active	Q1 is low-side output (NPN)	
			Q1 Driver PNP/NPN pushpull	Q1 is push-pull output	
		Return		Return to level 2	
		Q2 Function sel.	Q2 Upper Sw. Pt. Value: 001500	Q2 Upper Sw. Pt. act Value: 001500	Upper switching point of output Q2 in millimetres
Q2 Lower Sw. Pt. Value: 000199			Q2 Lower Sw. Pt. act Value: 000199	Lower switching point of output Q2 in millimetres	199
Q2 Hysteresis Value: 000020			Q2 Hysteresis act Value: 00020	Switching hysteresis of output Q2 in millimetres	20
Q2 light/dark light switching			Q2 light/dark light switching	Q2 is active if an object is present in the switching range	X
			Q2 light/dark dark switching	Q2 is active if no object is present in the switching range	
		Q2 Driver PNP high active	Q2 Driver PNP high active	Q2 is high-side output (PNP)	X
			Q2 Driver NPN low active	Q2 is low-side output (NPN)	
			Q2 Driver PNP/NPN pushpull	Q2 is push-pull output	
		Return		Return to level 2	
Return				Return to level 1	

Level 1	Level 2	Level 3	Level 4	Explanation / Notes	Default	
Serial COM Menu	COM Function sel ASCII Distance	COM Function sel ASCII Distance		Serial transmission, output in ASCII, 5 bytes, resolut. 1 mm	X	
		COM Function sel ASCII Dist. .1mm		Serial transmission, output in ASCII, 6 bytes, resolut. 0.1 mm		
		COM Function sel Distance 14 bit		Serial transmission, 2 bytes, 15m meas. range, res. 1 mm		
		COM Function sel Distance 16 bit		Serial transmission, 3 bytes, 30m meas. range, res. 1 mm		
		COM Function sel Distance 20bit		Serial transmission, 4 bytes, 30m meas. range, res. 0.1 mm		
		COM Function sel Remote Control		Remote control activated, RS 232 no bus operation		
		COM Function sel switched OFF		Serial data transmission deactivated		
		Node Address Value: 000	Node Address act Value: 000		Node address 0 ... 14	0
		Baudrate COM Baudrate 9600	Baudrate COM Baudrate 9600		Baud rate 9600 bit/s	X
			Baudrate COM Baudrate 19200		Baud rate 19200 bit/s	
		Baudrate COM Baudrate 28800		Baud rate 28800 bit/s		
		Baudrate COM Baudrate 38400		Baud rate 38400 bit/s		
		Baudrate COM Baudrate 57600		Baud rate 57600 bit/s		
		Baudrate COM Baudrate 115200		Baud rate 115200 bit/s		
		Baudrate COM Baudrate 600		Baud rate 600 bit/s		
		Baudrate COM Baudrate 1200		Baud rate 1200 bit/s		
		Baudrate COM Baudrate 2400		Baud rate 2400 bit/s		
		Baudrate COM Baudrate 4800		Baud rate 4800 bit/s		
	Stopbits COM 1	Stopbits COM 1		Number of stop bits: 1	X	
		Stopbits COM 2		Number of stop bits: 2		
	Return			Return to level 1		
Service Menu	Password Check inactive	Password Check inactive		Password for menu access not active	X	
		Password Check activated		Menu access password active, password: 165 (n. changeable)		
	ODSL 30 Serial No Val: 99999			Display of serial number, no changes possible		
	SW V01.20 VYMMDD Val: 31024			Display of software version, no changes possible		
	Parameter VYMMDD Val: 31024			Display of parameter version, no changes possible		
	Interface-Type RS 232 Interface			Display of the interface type, no changes possible		
	Return			Return to level 1		
Exit from Menu				Return to measurement mode		

3.6.4 Configuration / menu structure ODSL 30/D 485... (digital RS 485)

Level 1	Level 2	Level 3	Level 4	Explanation / Notes	Default	
 <p>Notice</p> <p>The functions under Applic. Param. are not available until the Advanced Menu is activated (see chapter 3.7)</p>	Applic. Param. Tmeas Band Rem. 100ms 150m 6-90%	Tmeas Band Rem. 100ms 150m 6-90%		Measurement time / uniqueness range / object reflectivity	X	
		Tmeas Band Rem. 80ms 39m 6-90%		Measurement time / uniqueness range / object reflectivity		
		Tmeas Band Rem. 70ms 9.8m 6-90%		Measurement time / uniqueness range / object reflectivity		
		Tmeas Band Rem. 50ms 150m 50-90%		Measurement time / uniqueness range / object reflectivity		
		Tmeas Band Rem. 40ms 39m 50-90%		Measurement time / uniqueness range / object reflectivity		
		Tmeas Band Rem. 30ms 9.8m 50-90%		Measurement time / uniqueness range / object reflectivity		
		Disp. Resolution 1mm	Disp. Resolution 1mm		Display resolution 1 mm	X
				Disp. Resolution 0.1mm	Display resolution 0.1 mm	
		Offset/Preset	Offset Direction ... Positive	Offset Direction ... Positive	Offset sign positive	X
				Offset Direction ... Negative	Offset sign negative	
			Offsetvalue [mm] Value: 000000	Offsetvalue [mm] act Val. 000000	Offset value, entry in mm	0
				Presetvalue [mm] Value: 000000	Presetvalue [mm] act Val. 000000	Preset value, entry in mm
			Preset Calculate ... inactive	Preset Calculate ... active	Trigger of the preset function	
Return			Return to level 1			
Input Menu	Inf. teach Q1/Q2 Teach Out Q1/Q2	Inf. teach Q1/Q2 Teach Out Q1/Q2	Teach input is activated	X		
		Inf. teach Q1/Q2 Input disabled	Teach input is deactivated			
	Input activ/ref Referencins	Input activ/ref Referencins	Input is referencing input	X		
		Input activ/ref Activation + Ref	Input is activation and referencing input			
		Input activ/ref Input disabled	Input activ is deactivated			
	Input Polarity active HIGH +24V	Input Polarity active HIGH +24V	All inputs are active high	X		
		Input Polarity active LOW 0V	All inputs are active low			
	Return			Return to level 1		

Level 1	Level 2	Level 3	Level 4	Explanation / Notes	Default	
Output Q Menu	Q1 Function sel.	Q1 Upper Sw. Pt. Value: 001000	Q1 Upper Sw. Pt. act Value: 001000	Upper switching point of output Q1 in millimetres	1000	
		Q1 Lower Sw. Pt. Value: 000199	Q1 Lower Sw. Pt. act Value: 000199	Lower switching point of output Q1 in millimetres	199	
		Q1 Hysteresis Value: 000020	Q1 Hysteresis act Value: 000020	Switching hysteresis of output Q1 in millimetres	20	
		Q1 light/dark light switching	Q1 light/dark light switching	Q1 is active if an object is present in the switching range	X	
			Q1 light/dark dark switching	Q1 is active if no object is present in the switching range		
		Q1 Driver PNP high active	Q1 Driver PNP high active	Q1 is high-side output (PNP)	X	
			Q1 Driver NPN low active	Q1 is low-side output (NPN)		
			Q1 Driver PNP/NPN pushpull	Q1 is push-pull output		
			Return		Return to level 2	
			Q2 Function sel.	Q2 Upper Sw. Pt. Value: 001500	Q2 Upper Sw. Pt. act Value: 001500	Upper switching point of output Q2 in millimetres
Q2 Lower Sw. Pt. Value: 000199	Q2 Lower Sw. Pt. act Value: 000199			Lower switching point of output Q2 in millimetres	199	
Q2 Hysteresis Value: 000020	Q2 Hysteresis act Value: 000020			Switching hysteresis of output Q2 in millimetres	20	
Q2 light/dark light switching	Q2 light/dark light switching			Q2 is active if an object is present in the switching range	X	
	Q2 light/dark dark switching			Q2 is active if no object is present in the switching range		
Q2 Driver PNP high active	Q2 Driver PNP high active			Q2 is high-side output (PNP)	X	
	Q2 Driver NPN low active			Q2 is low-side output (NPN)		
	Q2 Driver PNP/NPN pushpull			Q2 is push-pull output		
	Return				Return to level 2	
	Return				Return to level 1	

Level 1	Level 2	Level 3	Level 4	Explanation / Notes	Default	
Serial COM Menu	COM Function sel ASCII Distance	COM Function sel ASCII Distance		Serial transmission, output in ASCII, 5 bytes, resol. 1 mm	X	
		COM Function sel ASCII Dist. .1mm		Serial transmission, output in ASCII, 6 bytes, resol. 0.1 mm		
		COM Function sel Distance 14 bit		Serial transmission, 2 bytes, 15m meas. range, res. 1 mm		
		COM Function sel Distance 16 bit		Serial transmission, 3 bytes, 30m meas. range, res. 1 mm		
		COM Function sel Distance 20bit		Serial transmission, 4 bytes, 30m meas. range, res. 0.1 mm		
		COM Function sel Remote Control		Remote control activated via bus commands		
		COM Function sel switched OFF		Serial data transmission deactivated		
		Node Address Value: 000	Node Address act Value: 000		Node address 0 ... 14	0
		Baudrate COM Baudrate 9600	Baudrate COM Baudrate 9600		Baud rate 9600 bit/s	X
			Baudrate COM Baudrate 19200		Baud rate 19200 bit/s	
	Baudrate COM Baudrate 28800		Baud rate 28800 bit/s			
	Baudrate COM Baudrate 38400		Baud rate 38400 bit/s			
	Baudrate COM Baudrate 57600		Baud rate 57600 bit/s			
	Baudrate COM Baudrate 115200		Baud rate 115200 bit/s			
	Baudrate COM Baudrate 600		Baud rate 600 bit/s			
	Baudrate COM Baudrate 1200		Baud rate 1200 bit/s			
	Baudrate COM Baudrate 2400		Baud rate 2400 bit/s			
	Baudrate COM Baudrate 4800		Baud rate 4800 bit/s			
Storbits COM	1	Storbits COM 1		Number of stop bits: 1	X	
		Storbits COM 2		Number of stop bits: 2		
		Return		Return to level 1		
Service Menu	Password Check inactive	Password Check inactive		Password for menu access not active	X	
		Password Check activated		Menu access password active, password: 165 (n. changeable)		
	ODSL 30 Serial No Val: 99999		Display of serial number, no changes possible			
	SW V01.20 VVMDD Val: 31024		Display of software version, no changes possible			
	Parameter VVMDD Val: 31024		Display of parameter version, no changes possible			
	Interface-Type RS 485 Interface		Display of the interface type, no changes possible			
Return		Return to level 1				
Exit from Menu			Return to measurement mode			























3.6.5 Operating example





The following values are to be configured for an ODSL 30/V... :

- calibrated current output 4 ... 20mA, characteristic curve with positive gradient and measurement range 500 ... 3500mm.
- upper switching point for output Q1 at 3000mm and lower switching point for output Q1 at 2000mm.



















The device is set to factory settings and is in measurement mode.









Configuring the calibrated current output

Action	Display	Explanation / Notes
Press an arbitrary key  ,  , or  .	Input Menu	You get to the configuration menu for the ODSL 30...
Press the keys  and  to change to the menu item "Analogue Out Menu".	Analogue Out Menu	Menu item for the configuration of the analogue output.
Select menu item with the  key.	Cal Ana. Output Current 4-20mA	Current output 4 ... 20mA is already set as the calibrated output.
Press the keys  and  to change to the menu item "Pos for min. val".	Pos for min. val Value: 000200	This menu item sets the distance value for the minimum analogue value.
Press the  key to edit the value.	Pos for min. val act Value: 00200	Ready for editing.
Press the  and  keys to change the present value to "500".	Pos for min. val new Value->00500	New value has been edited.
Apply the new value by pressing the  key.	to store Press ↓ new Val.: 00500	Applying.
Save the new value by pressing the  key.	Pos for min. val Value: 00500	Saving.
Press the keys  and  to change to the menu item "Pos for max. val".	Pos for max. val Value: 005000	This menu item sets the distance value for the maximum analogue value.
Press the  key to edit the value.	Pos for max. val act Value: 05000	Ready for editing.
Press the  and  keys to change the present value to "3500".	Pos for max. val new Value->03500	New value has been edited.
Apply the new value by pressing the  key.	to store Press ↓ new Val.: 03500	Applying.
Save the new value by pressing the  key.	Pos for max. val Value: 003500	Saving.
Change to the menu item "Return" by pressing the  and  keys.	Return	This menu item leads to the parent level.

Action	Display	Explanation / Notes
Select menu item with the  key.	<pre>Analogue Out Menu</pre>	Menu level 1.
Press the keys  and  to change to the menu item "Exit from Menu".	<pre>Exit from Menu</pre>	This menu item exits the configuration menu.
Select menu item with the  key.	<pre>Leuze electronic Dist. lmm1 10687</pre>	The device has returned to measurement mode

Configuring the switching points Q1

Action	Display	Explanation / Notes
Press an arbitrary key  ,  , or  .	<pre>Input Menu</pre>	You get to the configuration menu for the ODSL 30...
Press the keys  and  to change to the menu item "Output Q Menu".	<pre>Output Q Menu</pre>	This menu item configures the switching outputs.
Select menu item with the  key.	<pre>Q1 Function sel.</pre>	Menu item for the configuration of the switching output Q1.
Select menu item with the  key.	<pre>Q1 Upper Sw. Pt. Value: 001000</pre>	This menu item configures the upper switching point for output Q1.
Press the  key to edit the value.	<pre>Q1 Upper Sw. Pt. act Value: 001000</pre>	Ready for editing.
Press the  and  keys to change the present value to "3000".	<pre>Q1 Upper Sw. Pt. new Value->003000</pre>	New value has been edited.
Apply the new value by pressing the  key.	<pre>to store Press ↵ new Val.: 003000</pre>	Applying.
Save the new value by pressing the  key.	<pre>Q1 Upper Sw. Pt. Value: 003000</pre>	Saving.
Press the keys  and  to change to the menu item "Q1 Lower Sw. Pt.".	<pre>Q1 Lower Sw. Pt. Value: 000199</pre>	This menu item configures the lower switching point for output Q1.
Press the  key to edit the value.	<pre>Q1 Lower Sw. Pt. act Value: 000199</pre>	Ready for editing.
Press the  and  keys to change the present value to "2000".	<pre>Q1 Lower Sw. Pt. new Value->002000</pre>	New value has been edited.
Apply the new value by pressing the  key.	<pre>to store Press ↵ new Val.: 002000</pre>	Applying.
Save the new value by pressing the  key.	<pre>Q1 Lower Sw. Pt. Value: 002000</pre>	Saving.

Action	Display	Explanation / Notes
Change to the menu item "Return" by pressing the  and  keys.	Return	This menu item leads to the parent level.
Select menu item with the  key.	Q1 Function sel.	Menu level 2.
Change to the menu item "Return" by pressing the  and  keys.	Return	This menu item leads to the parent level.
Select menu item with the  key.	Output Q Menu	Menu level 1.
Press the keys  and  to change to the menu item "Exit from Menu".	Exit from Menu	This menu item exits the configuration menu.
Select menu item with the  key.	Leuze electronic Dist. Imml 10687	The device has returned to measurement mode

3.7 Advanced Menu (for software versions V01.10 and newer)



Notice!

For information on querying the device software version, see chapter 3.5.5.

In addition to the described functions, additional, new functions are available in the **Advanced Menu**:

- Setting an **offset/preset** value to compensate for mounting tolerances
- **Reduction in measurement time** to as little as 30ms
- Changing the **display resolution**

Also available in the Advanced Menu is the menu item **Applic. Param..** This can be used to change the measurement value output of the ODSL 30.



Notice!





To protect against unintentional access, the Advanced Menu is hidden from view by default and must first be activated by the user.



Attention!

Please be certain to read the following notices before you activate the advanced mode and change parameters in the menu item **Applic. Param..**

Activation of the advanced mode

- ↳ Hold down the  button **during measurement operation** for longer than 5s. The **Advanced Menu? NO ↑or↓ YES↓** display appears.
- ↳ Press the  or  button to cancel activation of the Advanced Menu.
- ↳ Confirm **Yes** by pressing the  button. The **Advanced Menu is activated now** display appears briefly.

The menu item **Applic. Param.** is now also available in menu level 1.

3.7.1 Setting an Offset/Preset Value - Compensating for Mounting Tolerances

Deviations which occur during mounting of the ODSL 30 can be compensated for with the **offset** or **preset** parameter:

- For **offset**, a fixed value and sign are specified.
- For **preset**, a nominal measurement value is specified; a measurement is then performed using an object located at the desired nominal distance.



Attention!

If the offset or preset results in negative measurement values, zero is output at the interface and on the display.

Setting the offset

Configuration is performed using the key pad and display:

Appl. Param. -> Offset/Preset

The following can be entered:

- **Offset Direction**
Selection... **positive** or ... **negative**, i.e. specifies whether the offset value is added to or subtracted from the measurement value.
- **Offsetvalue [mm]**
Enter the offset value.

The set offset value is subtracted from the calculated (digital) measurement value of the sensor if **negative** was set for the **Offset Direction**.

Example:

Measurement value of the ODSL 30:	1500mm,
Input:	Offsetvalue: 100mm, Offset Direction: ... negative
Output on the display and at the interface:	1400mm

Setting the preset

Configuration is performed using the key pad and display:

Appl. Param. -> Offset/Preset

Procedure for setting a preset value:

- Enter nominal value -> **Presetvalue [mm]**
- In menu item **Preset calculate**, select the option ... **active**
- Press the  button to confirm.
A measurement is made, the preset is stored and the ODSL 30 is ready.

The offset value is automatically calculated from the measurement value and nominal measurement value (preset value) and entered as the offset in the configuration. **A preset is deactivated by entering an offset value of zero.**

Example:

Input:	Preset value: 1400mm,
Object dist. 1300mm in front of ODSL 30:	Preset Calculation ...active, trigger measurement, an offset of +100mm is automatically stored
Object distance 1300mm:	Output on display and at interface: 1400mm
Object distance 1400mm:	Output on display and at interface: 1500mm

3.7.2 Reduction in Measurement Time to as Little as 30ms

Definition of uniqueness range

Due to the periodicity of the sinusoid, the phasing of the signals received by the ODSL 30 limits the determination of unique measurement values to within a specific interval. The length of this interval is called the uniqueness range. A large uniqueness range is equivalent to high background suppression.

Relationship between uniqueness range - luminosity coefficient - measurement time

In the default setting (uniqueness range 150m, measurement on both light as well as dark objects with luminosity coefficients of 6 ... 90%), the measurement time is 100ms.

By limiting the uniqueness range and the luminosity coefficient (measurements on only light objects with luminosity coefficients of 50 ... 90%), the measurement time can be reduced to as little as 30ms.

Configuration is performed using the key pad and display:

Applic. Param. -> Tmeas Band Rem.

Changes to these variables yield measurement times as shown in the following table:

Measurement time [ms]	Uniqueness range [m]	Object luminosity coefficient [%]	Setting in the menu item Tmeas Band Rem.
30	9.8	50 ... 90 (light objects)	30ms 9.8m 50-90%
40	39		40ms 39m 50-90%
50	150		50ms 150m 50-90%
70	9.8	6 ... 90 (light and dark objects)	70ms 9.8m 6-90%
80	39		80ms 39m 6-90%
100 ¹⁾	150		100ms 150m 6-90%

1) Default setting



Notice!

By using the cooperative target CTS 100x100 (Part No. 501 04599), you ensure that the luminosity coefficient on the surface being measured is 50 ... 90%.



Attention!

If an object is located at a distance greater than the preselected uniqueness range, incorrect measurements will result (provided the reception signal is sufficiently high)!

Example:

With a uniqueness range of 9.8m, an object is located at a distance of 1 m. The sensor outputs a correct measurement value of 1 m.

If the object is located at a distance of 10.8m or 20.6m or 30.4m etc. from the sensor, the sensor outputs an incorrect measurement value of 1 m, i.e. a correct measurement value is only output for objects located within the uniqueness range.

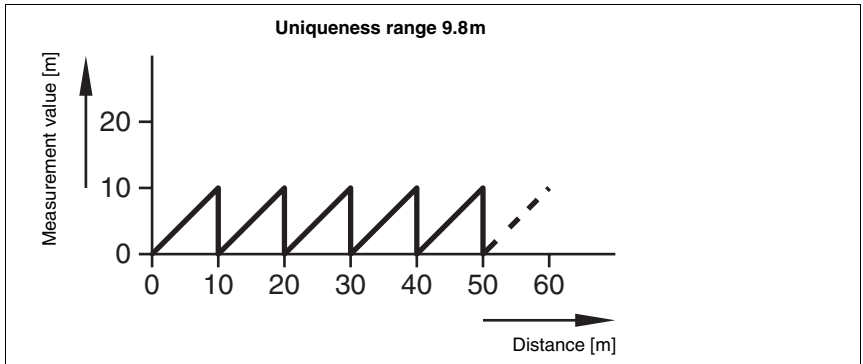

Figure 3.11: ODSL 30 measurement values with a uniqueness range of 9.8m

3.7.3 Changing the Display Resolution

On delivery, the measurement resolution of the ODSL 30 (display) is 1 mm. In the advanced mode, the resolution of the display can be increased to 0.1 mm by configuring with the key pad and display:

Applic. Param. -> Disp. Resolution 0.1mm.

**Notice!**

*This menu item refers **only to the display**. Changing this parameter has **no direct effect on the output** at the serial or analogue interfaces.*

If you would like to transmit measurement data with a resolution of 0.1 mm using the ODSL 30/D... with serial interface, this can be configured at a different location (see chapter 3.4.3).

For the ODSL 30/V..., the measurement range is to be restricted by appropriately configuring the analogue output.

The configuration of a resolution of 0.1 mm is useful when performing measurements on objects with high diffuse reflection and when the measurement data are processed further (e.g. averaging).

4 Technical Data ODSL 30

4.1 Optical data

ODSL 30	
Optical data	
Measurement range ¹⁾	0.2 ... 30m ²⁾
Resolution	1 mm
Light source	laser (modulated light)
Wavelength	655nm (visible red light)
Light-spot diameter	divergent, Ø6mm at a distance of 10m
Minimum object size	50x50mm ² at a distance of 10m (6 ... 90% diffuse reflection)
Error limits ³⁾	
Absolute measurement accuracy ¹⁾	± 5 mm (6 ... 90% diffuse reflection), ± 2 mm (90% diffuse reflection) after referencing
Repeatability ⁴⁾	± 2 mm (6 ... 90% diffuse reflection)
Temperature drift	typ. 0.5 mm/K (without referencing)
Timing	
Measurement time	100ms (90% diffuse reflection)
Delay before start-up	≤1 s

- 1) Reflectance factor 6% ... 90%, over the whole temperature range, measured object $\geq 50 \times 50\text{mm}^2$
- 2) ODSL 30/D... up to 65m, luminosity coefficient 50 ... 90%
- 3) After an operating time of 10 min., the device has reached the operating temperature required for an optimal measurement.
- 4) Same object, measured object $\geq 50 \times 50\text{mm}^2$

4.2 Electrical Data, Installation Data

4.2.1 ODSL 30/V-30M-S12

ODSL 30/V-30M-S12	
Electrical data	
Operating voltage U_B	18 ... 30VDC (incl. residual ripple)
Residual ripple	$\leq 15\%$ of U_B
Power consumption	$\leq 4W$
Switching output ¹⁾	1 PNP transistor output, HIGH active (default), NPN transistor or push-pull through configuration
Signal voltage high/low	$\geq (U_B - 2V) / \leq 2V$
Output current	max. 100mA per transistor output
Analogue output	1 voltage output 1 ... 10V ($R_L \geq 2k\Omega$) 1 current output ²⁾ 4 ... 20mA ($R_L \leq 500\Omega$)
Error limits	
Absolute measurement accuracy ³⁾	$\pm 5mm$ (6 ... 90% diffuse reflection), $\pm 2mm$ (90% diffuse reflection) after referencing
Repeatability ^{3) 4)}	$\pm 2mm$ (6 ... 90% diffuse reflection)

- 1) LC display and key pad at the device for configuration
- 2) The current output is calibrated
- 3) Minimum value is dependent on the configuration of the analogue output
- 4) Same object, identical environmental conditions, measurement object $\geq 50 \times 50mm^2$

4.2.2 ODSL 30/24-30M-S12

ODSL 30/24-30M-S12	
Electrical data	
Operating voltage U_B	10 ... 30VDC (incl. residual ripple)
Residual ripple	$\leq 15\%$ of U_B
Power consumption	$\leq 4W$
Switching outputs ¹⁾	3 PNP transistor outputs, HIGH active (default), NPN transistor or push-pull through configuration
Signal voltage high/low	$\geq (U_B - 2V) / \leq 2V$
Output current	max. 100mA per transistor output

- 1) LC display and key pad at the device for configuration

4.2.3 ODSL 30/D 232-30M-S12

ODSL 30/D 232-30M-S12	
Electrical data	
Operating voltage U_B	10 ... 30VDC (incl. residual ripple)
Residual ripple	$\leq 15\%$ of U_B
Power consumption	$\leq 4W$
Switching outputs ¹⁾	2 PNP transistor outputs, HIGH active (default), NPN transistor or push-pull through configuration
Signal voltage high/low	$\geq (U_B - 2V) / \leq 2V$
Output current	max. 100mA per transistor output
Serial interface	RS 232, 9600 Baud (default), baud rate adjustable
Transmission protocol	see chapter 3.4.3

1) LC display and key pad at the device for configuration

4.2.4 ODSL 30/D 485-30M-S12

ODSL 30/D 485-30M-S12	
Electrical data	
Operating voltage U_B	10 ... 30VDC (incl. residual ripple)
Residual ripple	$\leq 15\%$ of U_B
Power consumption	$\leq 4W$
Switching outputs ¹⁾	2 PNP transistor outputs, HIGH active (default), NPN transistor or push-pull through configuration
Signal voltage high/low	$\geq (U_B - 2V) / \leq 2V$
Output current	max. 100mA per transistor output
Serial interface	RS 485, 9600 Baud (default), no termination, baud rate adjustable
Transmission protocol	see chapter 3.4.3

1) LC display and key pad at the device for configuration

4.3 Mechanical Data, Environmental Data

	ODSL 30
Mechanical data	
Housing	metal
Optics cover	glass
Weight	650g
Connection type	M 12 connector, 8-pin
Environmental data	
Ambient temp. (operation/storage)	0 ... +45°C / -40 ... +70°C
Extraneous light limit	≤ 5kLux
Protective circuit ¹⁾	2, 3
VDE safety class ²⁾	II, all-insulated
Protection class	IP 65
Standards applied	IEC 60947-5-2

- 1) 2=polarity reversal protection, 3=short-circuit protection for all outputs
- 2) Rating voltage 250VAC

4.4 Dimensioned and Connection Drawings

All ODSL 30 variants

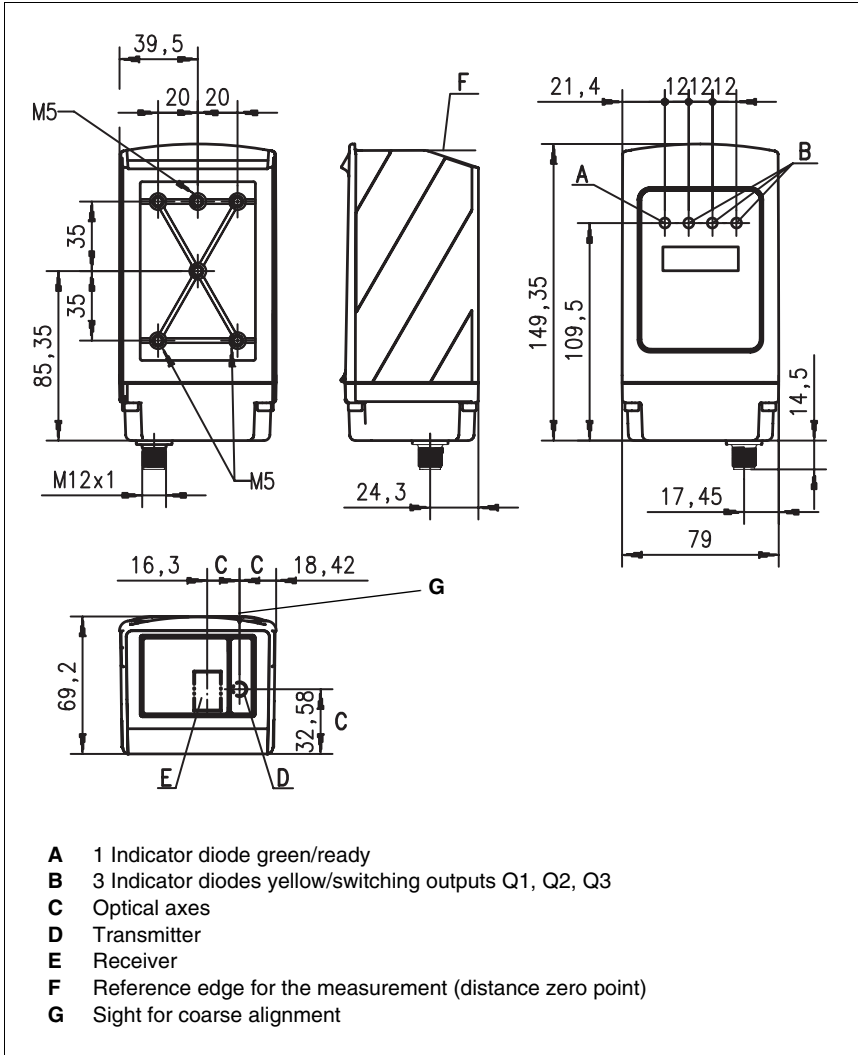

Figure 4.1: Dimensioned drawing ODSL 30 variants

ODSL 30/V... (analogue output)

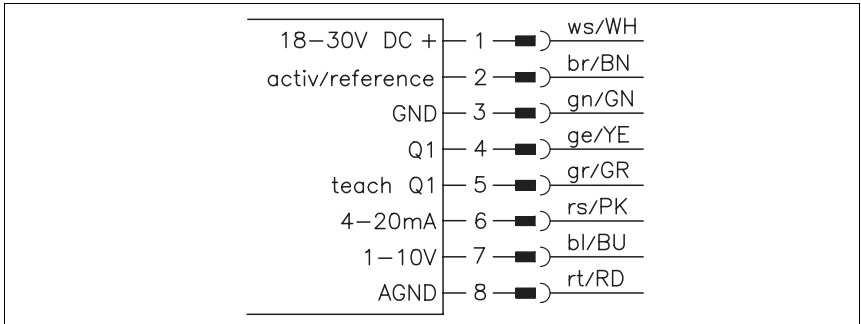

Figure 4.2: Electrical Connection ODSL 30/V...

ODSL 30/24... (3 switching outputs)

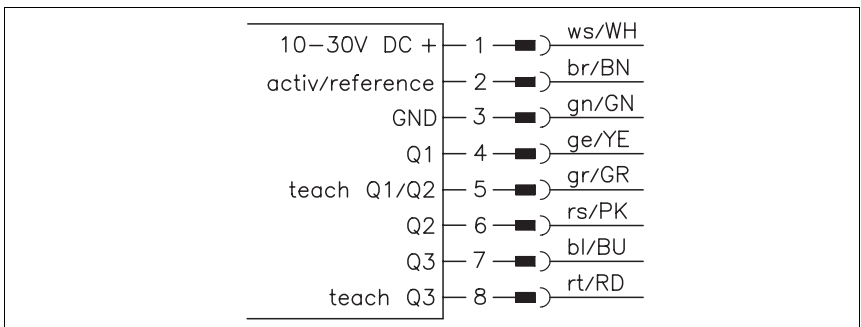

Figure 4.3: Electrical Connection ODSL 30/24...

ODSL 30/D 232... (digital output RS 232)

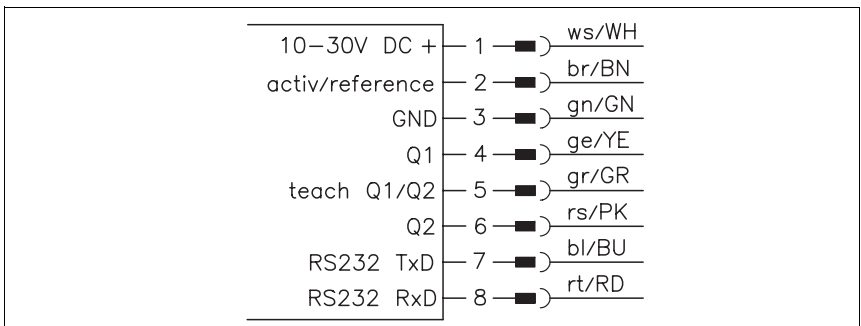

Figure 4.4: Electrical Connection ODSL 30/D 232...

ODSL 30/D 485... (digital output RS 485)

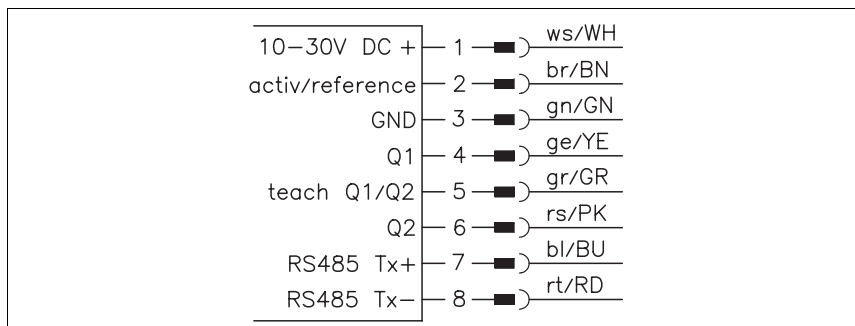

Figure 4.5: Electrical Connection ODSL 30/D 485...

4.5 Accessories

The following accessories are available for the ODSL 30:

Designation	Order No.	Short descriptions
K-D M12A-8P-2m-PUR	50104591	Connection cable M12, 8-pin, axial, length 2m
K-D M12A-8P-5m-PUR	50104590	Connection cable M12, 8-pin, axial, length 5m
UPG 5 ¹⁾	50039627	Programming adaptor for ODSL 8/ODSL 30/ ODS 96
ODS 96 configuration software ²⁾		Download at www.leuze.de
CTS 100x100	50104599	Cooperative target, luminosity coefficient 50 ... 90%

1) Required for the visualisation of the measurement values via the ODS 96 configuration software.

2) With the ODSL 30..., this can only be used exclusively for the visualisation of measurement values on the PC; configuration is not possible!



Notice

In connection with the ODSL 30, the configuration software can only be used for the display of measurement values, but not for the configuration of the device.

5 Installation

5.1 Storage, Transportation

Unpacking

- ↳ Check the packaging for any damage. If damage is found, notify the post office or shipping agent as well as the supplier.
- ↳ Check the delivery contents using your order and the delivery papers:
 - delivered quantity
 - device variant and model as indicated on the nameplate
 - accessories
 - operating manual
- ↳ Save the original packaging for later storage or shipping.

If you have any questions concerning your shipment, please contact your supplier or your local Leuze electronic sales office.

- ↳ Observe the local regulations regarding disposal of packaging material.

5.2 Mounting



Notice

The mounting device BT 30 is already included in the delivery package of the ODSL 30.

View through a chase

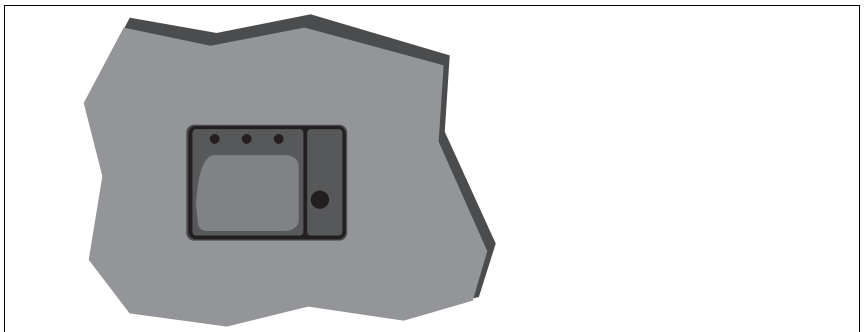

Figure 5.1: View through a chase

If the ODSL 30 has to be installed behind a cover, the chase has to have at least the size of the optical glass cover. Otherwise, a correct measurement is not possible or can not be guaranteed.

5.3 Teach-in

You can adjust the upper switching points by means of teach-in; with the ODSL 30/V..., you can also set the characteristic output curve of the analogue output by means of teach-in. For teach-in, there are differences among the various device variants:

Teach procedure for ODSL 30/V... (1 switching output)

☞ *Position the measured object at the desired distance. Connect the teach input **teach Q1** for ≥ 2 sec. to $+U_B$. After that, connect the teach input to GND. The switching output is taught.*

Teaching takes place towards the switching point.

These default values are preset:

- Function characteristics of the switching output: "light switching"
- Lower switching point: 199mm
- Upper switching point: 1000mm
- Hysteresis: 20mm

You can change these values using the key pad and LCD display.

Teach-in of the characteristic output curve of the ODSL 30/V...

In addition to the edge-controlled teach-in (EDGE CONTROL) of the switching outputs, teach-in of the characteristic output curve is also possible via a teach line for devices with software version V01.10 and newer (see chapter 3.5.5). The following steps are required for the line teach-in of the analogue characteristic curve:

1. Activation of the analogue line teach function via the key pad and menu.
Activate **Input Menu** -> **Teach Mode** -> **Teach Mode time control**.
2. Position the measured object at the desired distance.
3. The respective teach function is activated by applying the active level (default $+U_B$) to the teach input "Teach Q1" (pin 5). The teach event is indicated by the flashing of the LEDs and on the display.

Teach function	Duration of teach signal	LED green	LED yellow
Upper switching point switching output Q1	2 ... 4 s	flash synchronously	
Distance value for analogue output 1 V / 4 mA	4 ... 6 s	continuous light	flashing
Distance value for analogue output 10 V / 20 mA	6 ... 8 s	flashing	continuous light

4. To finish the teach event, disconnect the teach input from the teach signal after the desired time.
5. A successful teach event is signalled by the end of the flashing of the LEDs. The menu entries can be used to check that the teach values are properly accepted and to make any changes.

Error messages

Rapid flashing of the green LED following a teach event indicates an unsuccessful teach event. The sensor remains ready for operation and continues to function with the old values.

Remedy:

- Repeat teach event **or**
- Activate teach input for more than 8s **or**
- Disconnect sensor from voltage to restore the old values.

Teach procedure for ODSL 30/D... (2 switching outputs)

- ↪ *Position the measured object at the first desired distance. Connect the teach input **teach Q1/Q2** for ≥ 2 sec. to $+U_B$. The LEDs are flashing simultaneously. Reconnect the teach input to GND. The first switching output is taught.*
- ↪ *Now, position the measured object at the second desired distance. Connect the teach input **teach Q1/Q2** for ≥ 2 sec. to $+U_B$. The LEDs now flash alternately. Reconnect the teach input to GND. The second switching output is taught. In non-operational mode, the teach input is connected to GND.*

Teaching takes place towards the switching points.

These default values are preset:

- Function characteristics of the switching outputs: "light switching"
- Lower switching point Q1: 199mm, lower switching point Q2: 199mm
- Upper switching point Q1: 1000mm, upper switching point Q2: 1500mm
- Hysteresis: 20mm each

You can change these values using the key pad and LCD display.

Teach procedure for ODSL 30/24... (3 switching outputs)

- ↪ *Switching outputs Q1/Q2: Teach procedure is the same as for ODSL 30/D...*
- ↪ *Switching output Q3: Teach procedure is the same as for ODSL 30/V... via teach input **teach Q3***

Teaching takes place towards the switching points.

These default values are preset:

- Function characteristics of the switching outputs: "light switching"
- Lower switching point Q1: 199mm, lower switching point Q2: 199mm, lower switching point Q3: 199mm
- Upper switching point Q1: 1000mm, upper switching point Q2: 1500mm, upper switching point Q3: 2000mm
- Hysteresis: 20mm each

You can change these values using the key pad and LCD display.

6 Software

General description

The ODS 96 configuration software can be used with a connected ODSL 30 to display measurement values.

The software is available via download from www.leuze.de.



Notice

In connection with the ODSL 30, the ODS 96 configuration software can only be used for the display of measurement values, but not for the configuration of the device. For this purpose, the left arrow key (up arrow) on the key pad must be pressed while the device is switched on. After that, the ODSL 30 is in PC configuration mode.

6.1 Connection to a PC

6.1.1 Connection of the ODSL 30 to a PC

The ODSL 30 is connected to a PC via the programming terminal UPG 5. The terminal is simply inserted between the ODSL 30 and the connection cable. The UPG 5 is connected to the PC via the serial interface cable that ships with the UPG 5.

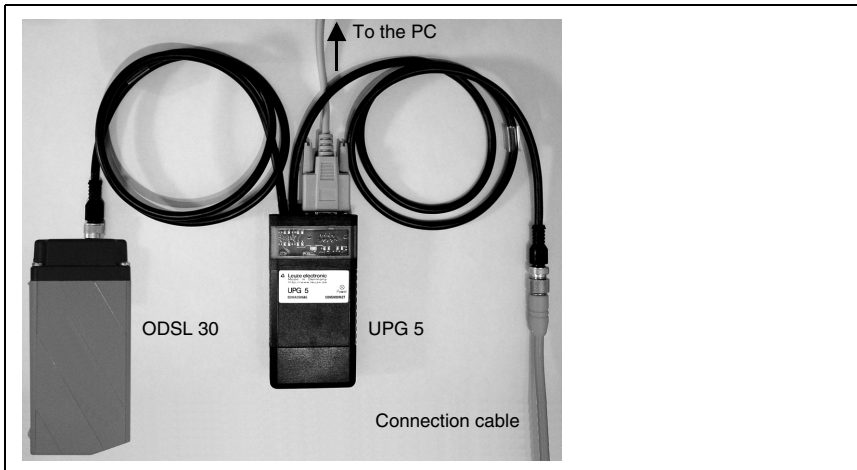

Figure 6.1: Connection of the ODSL 30 to a PC via the programming terminal UPG 5



Notice

The measurement values of the ODSL 30 can visualised on the PC using the ODS 96 configuration software. However, a configuration of the device via the ODS 96 configuration software is not possible. Visualisation of the measurement values is only possible up to 15m!

6.2 Installation of the ODS 96 configuration software

Requirements for the installation of the configuration software:

- Windows 95/98/NT/2000/XP,
- 486 processor or faster,
- 4 MByte RAM,
- 2 MByte free disk space
- and a CD-ROM drive.

Starting the Installation File

- ↳ Insert the installation CD into your CD drive.
- ↳ Choose **Start** → **Run**. Insert drive and name of the installation file (e.g.: d:\setup.exe) and hit **OK**.
- ↳ In the following window, define the path for the installation directory and confirm with **End**.

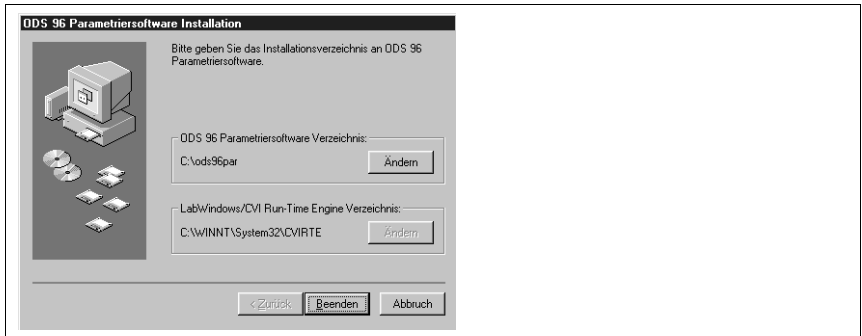

Figure 6.2: Installation directory

- ↳ Follow the installation routine.

6.3 Starting the Program

After successful installation and restart of the computer, the configuration software is ready to use.

- ↳ Choose the ODS 96 configuration software icon from the program group.

Without connected ODSL 30, the following window appears after the program start, letting you choose a device:

Additional window without connected ODSL 30

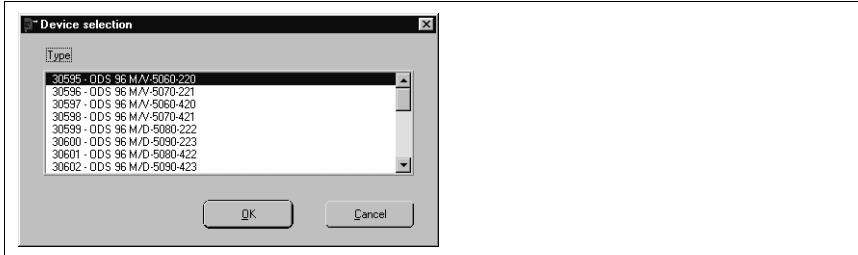

Figure 6.3: Device selection

If an ODSL 30... is connected, the following window appears:

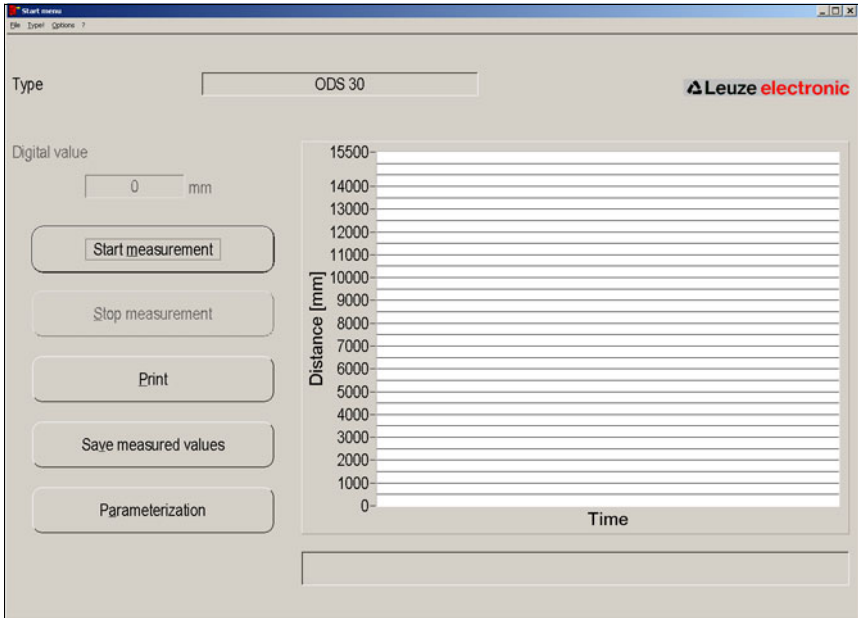

Figure 6.4: Start menu before measurement

The software automatically recognises the connected sensor with its default settings.

6.3.1 Description of the Menu Commands

Menu item "File"

Under menu item **File** you can switch to configuration mode or quit the program.

Menu item "Type!"

The menu item **Type!** is used for the default setting of parameters and the generation of parameter files without an ODS being connected. It lets you choose a device variant that you wish to configure.

Menu item "Options"

The following three possibilities are offered under **Options**:

- **Language selection** to choose the language for dialog.
- **Interface** to choose the port to which the cable to the ODSL 30 is connected (standard: COM 1). The configuration software automatically recognises the interface used. Choosing a different port could become necessary if more than one sensor is connected.
- **Change password**: first enter your old, then your new password and confirm with **OK**.

Menu item "?"

Choose **About...**, for information on ODS 96 configuration software (product, program, device version, as well as for the address of Leuze electronic).

6.3.2 Measurement

By clicking the button **Start measurement**, the current measurement data of the connected ODSL 30 are transmitted and plotted in the adjacent diagram as a function of time.

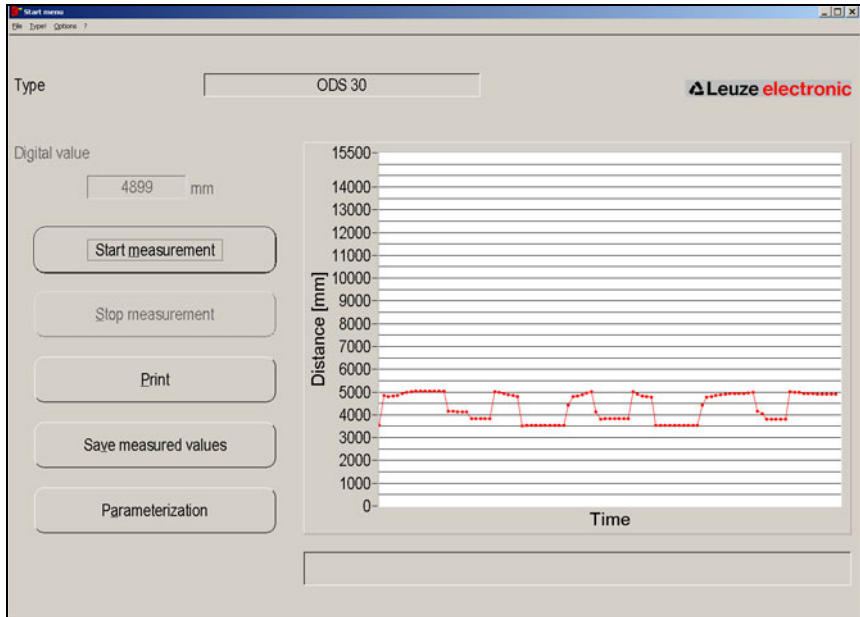

Figure 6.5: Display of the current measurement values of the ODSL 30 connected

By clicking the button **Stop Measurement**, you terminate the transmission of the measurement values from the ODSL 30 and freeze the measurement diagram.

With a subsequent click on the button **Print**, the diagram is output on your standard Windows printer.